

Text Book of **MICROBIOLOGY**

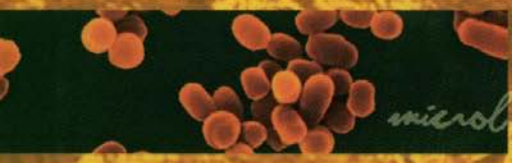
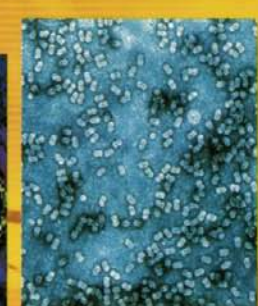
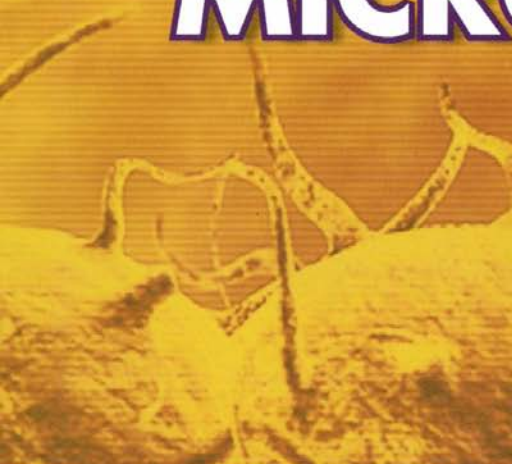

**P. C. Trivedi
Sonali Pandey
Seema Bhadauria**

robiology

TEXT BOOK OF MICROBIOLOGY

Prof. Pravin Chandra Trivedi (b. 3 March, 1953), Ph.D., Post-Doct. (U.S.A.), F.L.S. (London), F.B.S., F.P.S.I., F.B.R.S., F.M.A., F.E.S., F.N.R.S., F.I.A.T., Professor, Department of Botany, has a brilliant academic career standing first in all examinations. Prof. Trivedi served as Head, Department of Botany and Co-ordinator, P.G. Course in Biotechnology (2003-06); Director, College Development Council (2001-04); Vice-Principal, Maharaja's College (2000-03) and is Member of Senate, Academic Council and Convenor of BOS Botany in the University of Rajasthan.

He worked as Post-Doctoral Fellow at the Department of Plant Pathology, North Carolina State University, Raleigh, U.S.A. in 1983-84. Prof. Trivedi has 35 years of teaching and research experience in the University of Rajasthan, Jaipur. He has published more than 250 research papers and review articles in journals of repute. He has edited and written more than 110 books and guided 38 Ph.D. students. He has been the Principal Investigator of 20 major research projects funded by national organisations. He is an elected Fellow of nine reputed academic bodies. Dr. Trivedi visited several major research laboratories and delivered invited talks in many international conferences.

Prof. Trivedi is an elected Secretary of the Indian Botanical Society (2005-2010); Council Member of Indian Science Congress Association, Kolkata (2007-09) and a member of the editorial and advisory boards of eight reputed journals. For his research contribution he was awarded Scientist of the Year Award (2001); M. J. Narsimhan Award (2004), Bioved Fellowship Award (2005), and Birbal Sahni Foundation Honour (2007). Rastriya Gaurav Samaan (2007); Distinction Award for Books (2009); Shiksha Vibhushan Samaan (2009).

Dr. Sonali Pandey, Ph.D., F.B.S., Senior Lecturer in Botany/Biotechnology, Mahatma Gandhi Institute of Applied Sciences, JECRC Foundation, Jaipur, Rajasthan, India, has a brilliant academic career, standing first in all examinations securing second position in University merit in M.Sc. Botany of University of Rajasthan.

Dr. Sonali is a dedicated teacher & eminent scholar. She received her Ph.D. in 2001 on the topic "Host-parasite relationship and biocontrol of *Heterodera cajani* infecting Cowpea" under the supervision of Prof. P.C. Trivedi. She has eleven years of teaching experience at U.G. and P.G. Level. She has published many research papers in journals of repute. She is one of the author of book published by Vardhaman Kota Open University for undergraduate students. She is active member of many National Academic Societies and Fellow of Indian Botanical Society. She has participated in many National Seminars & Symposium. Her major research interest includes Plant Nematology & Microbiology.

Dr. Seema Bhadauria, Senior Lecturer in Botany/Biotechnology is working at MGIAS, JECRC Foundation since last five years. She did her M.Sc. and Ph.D. from University of Rajasthan, Jaipur. Her specialized field of research work is Medical Mycology and Biochemistry. She has been teaching undergraduate and post graduate students of life science since 2003. She has been a author of many research papers of international and national Journals of repute and also guided many M.Phil and post graduate students. She is a coauthor of books published by Vardhaman Kota Open University.

TEXT BOOK OF MICROBIOLOGY

**P.C. Trivedi
Sonali Pandey
Seema Bhadauria**

**Aavishkar Publishers, Distributors
Jaipur 302 003 (Raj.) India**

First Published in 2010 by
Prem C. Bakliwal for
Aavishkar Publishers, Distributors
807, Vyas Building, Chaura Rasta
Jaipur 302 003 (Raj.) India
Phone : 0141-2578159
e-mail : aavishkarbooks@hotmail.com

© Authors

ISBN 978-81-7910-306-7

All rights reserved. No part of this publication may be reproduced or copied for any purpose by any means, manual, mechanical or electronic, without prior and written permission of the copyright owners and the publishers.

Printed at
Sheetal Printers
Jaipur (Raj.) India

PREFACE

Micro-organisms are the oldest inhabitants of earth. They are masters in versatility and adaptability to the changing environment. They will definitely prove to be most cost-effective partners in our efforts for sustainable development. The microorganisms influence the man in several ways. The diversity of their activities varies from causing diseases in human and other animals and plants to the production of various useful products. Microbes have a very significant role in the era of biotechnology and hence microbiology has today come forth as one of the most demanding subject in the science stream of graduate and post graduate courses.

The contents of the present book have been divided into 17 chapters covering basic studies of microorganisms excluding their application part. Book covers detailed information on history of microbiology, evolution of microorganisms, classification, Nomenclature and latest information of Bergey's manual. Chapter covers information about structure, metabolism reproduction, function and diseases caused by Bacteria, Viruses, Bacterial viruses, Plant viruses, Animal viruses, Archaea, Mycoplasma and Phytoplasma. General account of cyanobacteria including their nutrition and reproduction have been given. Book provides detailed information about Gram negative and Gram positive Bacteria and Eukaryotes viz. Algae and fungi.

At end of book appendix and various types of questions have been given for the benefit of students. A concise account of microorganisms is given in the text book, so as to make the students aware of the nature and other important aspects of the microorganisms.

Present book is a compilation of information on microbiology done in a manner so as to meet the need of students of microbiology of the Indian Universities. A large number of standard books on the subjects and research journals have been consulted. Grateful thanks are due to the authors, editors and publishers of these books and journals. Although we have tried our best to supply correct and latest information in this book,

errors or omissions might have crept in. We shall welcome comments suggestions and constructive criticism for future guidance and improvements.

We are specially indebted to Mr. Akshay Jain, Aavishkar Publishers, Distributors, Jaipur for his keen interest in bringing out the book in a nice form.

Jaipur

**P.C. Trivedi
Sonali Pandey
Seema Bhadauria**

CONTENTS

	<i>Preface</i>	v
1.	INTRODUCTION	1-3
	Major Fields of Pure Sciences; Major Fields of Applied Microbiology.	
2.	HISTORY OF MICROBIOLOGY	4-16
	Discovery Era – Antony Van Leeuwenhoek; Transition Period – F. Redi, Needham, Spallanzani; Historical development in the field of Microbiology; Golden Age of Microbiology – Louis Pasteur, Tyndall, L.J. Lister, Robert Koch, Hesse, Jenner, Metchnikoff, Roux, Paul Ehrlich, Domagk, Flemming; Era of Molecular Biology – Beadle & Tatum, Delbruck & Luria; Nobel Laureates in Microbiology.	
3.	EVOLUTION OF MICROORGANISM	17-27
	Origin of Universe – Nebular Hypothesis; Planetesimal Hypothesis; Tidal Hypothesis; Recent Hypothesis; The Primitive Atmosphere of Earth; Chemical Origin of Life (Chemogeny); Biological Evolution of Biogeny; Cognogeny.	
4.	CLASSIFICATION OF MICROORGANISM	28-51
	Hierarchical Arrangement in Taxonomy; Whittaker Five Kingdom Concept; Major Differential Features among Bacteria, Archaea and Eukarya; Modern Trends in Classification; Characters used for the Classification of Bacteria; Genome Comparison; RNA Finger Printing and Sequencing; DNA Sequencing; Microbial Phylogeny; Molecular Chronometers; Phylogenetic Trees; Taxonomic Criteria used for Classification & Identification of Bacteria.	

5. **NOMENCLATURE AND BERGEY'S MANUAL** 52-70
 Organization of Bergey's Manual; Classification of Prokaryotes.
6. **BACTERIA** 71-103
 General Character; Plant Like Characteristic in Bacteria; Structure of Bacterial Cell—Shapes of Bacteria, Ultrastructure, Flagella, Pili, Capsule, Cell Wall—Gram +ve and Gram -ve bacteria; Cytoplasmic Membrane; Ribosomes; Chromatophores, Cytoplasmic Inclusions, Gas Vacuoles, Nuclear Material, Plasmid; Nutrition in Bacteria—Photosynthetic, Chemosynthetic, Heterotrophic Bacteria; Reproduction in Bacteria—Vegetative (Binary fission, Budding, Cyst, Gonidia); Asexual (Conidia, Oidiospores, Sporangiospores, Motile spores, Endospores); Genetic Recombination (Transformation, Conjugation, Transduction); Gram Staining, Pathogenic Bacteria.
7. **VIRUSES** 104-123
 History, General Characters of Viruses, Difference of Virus from Bacteria and Mycoplasma, Nature of Viruses; Viroids; Virusoides; Prions; Size & Structure of Viruses; Chemical Composition; Viral Genome; Classification of Virus—LHT System, Gasjens & King Classification, Baltimore Scheme of Classification; Replication of Viruses—Lytic Cycle, Lysogenic Cycle; Interferon.
8. **BACTERIAL VIRUSES** 124-134
 DNA Bacterial Viruses (Phage M13; Bacterial Virus T4; Temperate Bacteriophages; λ Phage, Virus T7, MU Virus).
9. **PLANT VIRUSES** 135-168
 Morphology, Satellite Virus & RNA; Virus Infection—Symptoms (External & Internal); Classification & Nomenclature; Physiology & Cytology of Plants Infected with Viruses; Change in Low Molecular Weight Metabolites; Viral Diseases of Tomato (Leaf Curl of Tomato, Mosaic of Tomato); Rice Tungro Viruses; Sugarcane Mosaic; Algal Viruses—The Cyanophage—Properties, Life Cycle; Other Algal Viruses; Fungal Viruses—The Mycophages—Characteristics, Examples of Mycophages; Taxonomic Position of Mycophages; Tobacco Mosaic Virus; Cauliflower Mosaic Virus; Potato Virus; Transmission of Plant Viruses.
10. **THE ANIMAL VIRUSES** 169-250
 Replication of Animal Viruses (DNA Viruses, RNA Viruses); Classification of Animal Viruses; Classification of Human Viruses; Picornaviridae, Enteroviruses; Polioviruses; Coxsackieviruses, Echoviruses; Enteroviruses; Rhinoviruses; Rhabdoviruses; Rotaviruses; AIDS HIV Viruses; Poxviridae; Herpesvirus; Herpes Simplex Virus; Vericella—Zoster Virus; Epstein—Barr Virus; Cytomegalovirus; Adenovirus; Polymavirus; Hepatitis Viruses (Hepatitis A, B, C, D, E, G).

11. **ARCHAEA** 251-262
 Phylogeny; General Characteristics; Cell Wall; Plasma Membrane; Metabolism; Characteristics of the Major Archaeal Groups; Halobacteria.
12. **MYCOPLASMA** 263-268
 General Characteristics; Classification, Cell Structure; Reproduction, Economic Importance; Plant Diseases –Symptoms, Transmission; Human and Animal Diseases.
13. **PHYTOPLASMA** 269-274
 Mollicutes; Phytoplasmas –Occurrence & Maintenance, Detection; Vectors; Spread & Transmission; Disease Symptoms; Identification; Classification; Cure & Management; Little Leaf of Brinjal –Symptoms, Control.
14. **GENERAL ACCOUNT OF CYANOBACTERIA** 275-289
 General Characters of Cyanobacteria; Occurrence, Thallus Organization; Cell Structure, Photosynthetic Pigments and Chromatic Adaptation; Gas Vacuoles; Heterocyst –Physiology & Nature of Heterocyst, Function; Nutrition of Cyanobacteria; Reproduction –Vegetative (Fission, Fragmentation, Hormogonia); Asexual (Akinetes, Endospores, Exospores, Nannocytes, Hormospores); Genetic Recombination.
15. **GRAM -ve BACTERIA** 290-320
 Spirochetes –Movement, Cell division, Diversity, Symbiosis with Invertebrates; *Treponema pallidum*, *Borrelia*, Lyme diseases; Rickettsia; Chlamydia, Gliding Bacteria (The Myxobacteria); The Sheathed Bacteria – *Sphaerotilus*, *Leptothrix*, *Haliscomenobacter*, Chemolithotrophs; Anoxygenic Phototrophic Bacteria; Oxygenic Phototrophic Bacteria; Cyanobacteria; Nitrogen Fixing Cyanobacteria; The Purple Bacteria (Sulphur and Non-sulphur Bacteria); The Green Bacteria (Sulphur & Non-sulphur Bacteria); Budding Bacteria.
16. **GRAM +ve BACTERIA** 321-337
 Mycobacteria, *Mycobacterium tuberculosis* –Growth Characteristics, Pathogenicity; Endospore Forming Rods & Cocci; Anaerobic Spore Formers; *Bacillus* –Anthrax, *Clostridium*; Actinomycetes – Biotechnological Potential of Actinomycetes; Antibiotics from Actinomycetes.
17. **EUKARYOTA** 338-387
 Algae –General Characters, Habit & Habitat, Thallus Organization, Pigments, Reserve Food, Algal Cell –Flagella, Reproduction –Vegetative, Asexual & Sexual; Types of Life Cycle; Classification; Fungi –General Characters, Nutrition, Growth & Reproduction, Classification.

APPENDIX-1	388-381
Prokaryotes Notable for their Environmental Significance	
APPENDIX-2	391-394
Medically Important Chemoorganotrophs	
APPENDIX-3	394-395
Terms Used to Describe Microorganisms According to Their Metabolic Capabilities	
QUESTIONS	396-432
Short & Essay Type Questions; Multiple Choice Questions	
INDEX	433-446

1

INTRODUCTION

Microbiology is one of the most applied of all the biological sciences which did not exist as a true science before the later part of 19th century.

Microbiology is the study of microorganisms that is the organism which are of microscopic dimensions. These organisms are too small to be clearly perceived by the unaided human eye. Microorganisms are living organisms that are usually too small to be seen clearly with the naked eye. An organism with a diameter of 1 mm or less are microorganisms and fall into the broad domain of microbiology. Because most of the microorganisms are only a few thousands of a mm in size, they can only be seen with the aid of microscope. Due to the invisibility of microbes to the naked eye and the need for special techniques to study them, microbiology was the last of the three major divisions in biology (the other two are botany and zoology) to develop.

At present there is general agreement to include five major groups as microorganisms. The subdivisions are :

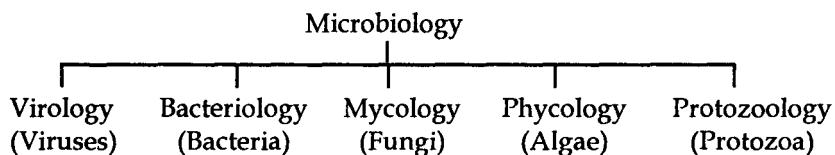

Microorganisms are present everywhere on earth which includes humans, animals, plants and other living creatures, soil, water and atmosphere. Microbes can multiply in all three habitats except in the atmosphere. Together their numbers far exceed all other living cells on this planet.

Microorganisms are relevant to all of us in a multitude of ways. The influence of microorganism in human life is both beneficial as well as detrimental also. For example microorganisms are required for the production of bread, cheese, yogurt, alcohol, wine,

beer, antibiotics (e.g. penicillin, streptomycin, chloromycetin), vaccines, vitamins, enzymes and many more important products. Microorganisms are indispensable components of our ecosystem. Microorganism play an important role in the recycling of organic and inorganic material through their roles in the C, N and S cycles, thus playing an important part in the maintenance of the stability of the biosphere. They are also the source of nutrients at the base of all ectotropical food chains and webs. In many ways all other forms of life depend on the microorganisms.

The use of microbes to reduce or degrade pollutants, industrial waste and household garbage, a new area referred to as bioremediations being given substantial importance these days. A common edible mushroom contain a protein lectin that can stop cancer cell multiplication. This discovery of 21st century could lead to new targets for therapy. Similarly an endophytic Fungus *Taxomcyes andreanae* is being used to produce taxol, an antitumor diterpenoid used in the treatment of some cancers. Taxol was originally obtained from the bark of *Taxus brevifolia*.

TABLE 1
Major Fields of Pure Sciences

Field	Some Applied Areas
Bacteriology	Study of bacteria
Mycology	Study of fungi (achlorophyllous, heterotrophic, eukaryotic with a rigid cell wall containing chitin/cellulose)
Protozoology	Study of protozoans (animal like single celled eukaryotic organisms).
Virology	Study of viruses and viral diseases.
Algology or Phycology	Study of algae.
Parasitology	Study of parasitism and parasites (include pathogenic protozoa, helminthes worms and certain insects).
Microbial ecology	Study of interrelationships between microbes and environment.
Microbial morphology	Study of detailed structure of microorganism.
Microbial taxonomy	Concerned with classification, naming and identification of microorganism.
Microbial Physiology	Study of metabolism of microbes at cellular and molecular levels.
Microbial genetics and Molecular Biology	Study of genetic material, structure and function and biochemical reactions of microbial cells involved in metabolism and growth.

Microorganisms also have harmed humans and disrupted societies over the millennia. Microbial diseases undoubtedly played a major role in historical events such as decline of the Roman empire and conquest of the new world. It was in the year 1347 when plague or 'black death' struck Europe and within 4 yrs killed 25 million people that is 1/3 of the population. This dreaded disease is believed to have changed european culture and prepared the way for renaissance. In addition to health threat from some microorganisms

many microbes spoil food and deteriorate materials like iron pipes, glass lenses, computer chips, jet fuel, paints, concrete, metal, plastic, paper and wood pilings.

TABLE 2
Major Fields of Applied Microbiology

Field	Some Applied Areas
Industrial Microbiology	Concerned with industrial uses of microbes in production of alcoholic beverages, vitamins, NH_2 -acids, enzymes, antibiotics and other drugs.
Agricultural Microbiology	Study of relationships of microbes and crops and on control of plant diseases and improvement of yields.
Food Microbiology	Deals with interaction of microorganisms and food in relation to food processing, food spoilage, food borne disease and their prevention
Dairy Microbiology	Deals with production and maintenance in quality control of dairy products.
Aquatic Microbiology	Study of microorganisms found in fresh estuarine and marine waters.
Air Microbiology	Deals with the role of aerospora in contamination and spoilage of food and dissemination of plant and animal diseases through air.
Exomicrobiology	Deals with exploration for microbial life in outer space.
Medical Microbiology	Causative agents of disease, diagnostic procedure for identification of causative agents, preventive measures.
Immunology	Deals with the immune system that protects against infection and to study serology reactions.
Public Health Microbiology	Concerns with monitoring, control and spread of diseases in communities.
Biotechnology	Scientific manipulation of living organisms especially at molecular and genetic level to produce useful products.

Microbiology is one of the largest and most complex of the biological sciences as it deals with many diverse biological disciplines. In addition to studying the natural history of microbes, it deals with every aspects of microbe-human and environmental interaction. These interactions include: ecology, genetics, metabolism, infection, disease, chemotherapy, immunology, genetic engineering, industry and agriculture. The branches that come under the large and expanding umbrella of microbiology are categorized into pure and applied sciences.

The branch microbiology has two major aspects: the theoretical and the applied. Doctors and farmers are applied microbiologist. For example the doctors has the primary interest to keep people healthy through the use of scientific knowledge while the scientist (theoretical) work is to obtain new information in his related field and guide the farmers to increase crop yield.

HISTORY OF MICROBIOLOGY

Microbiology is the study of living organisms of microscopic size. The term microbiology was given by French chemist Louis Pasteur (1822-95).

Microbiology is said to have its roots in the great expansion and development of the biological sciences that took place after 1850. The term microbe was first used by Sedillot (1878).

Microorganism were first living things to appear on earth and the study of fossil-remains indicate that microbial infections and epidemic diseases existed thousands of years ago. Varo and Columella in the first century BC postulated that diseases were caused by invisible beings (*Animalia minuta*) inhaled or ingested. Fracastorius of Verona (1546) proposed a *contagium vivum* as a possible cause of infections disease and Von Plenciz (1762) suggested that each disease was caused by a separate agent.

Rogen Bacon in the 13th century postulated that disease is produced by invisible living creatures. This suggestion was made again in 1546 by a physician Girolamo Fracastoro (1478-1553) of North Italy. He wrote a treatise- *De contagione* in which he said disease was caused by minute 'seed' or 'germ' and spread from person to person. His work represents a great landmark in the doctrine of infectious diseases.

In 1665, Robert Hook an English scientist used a simple lens that magnified objects approximately 30X. He examined thin slices of cork, the bark of oak tree and he referred to as "cells". Later the Hook work was followed by Matthias Schleiden and Theodore Schwann who examined a variety of organisms and later became foundation of "Cell Theory". The discovery of microbiology as a discipline could be traced along the following historical eras :

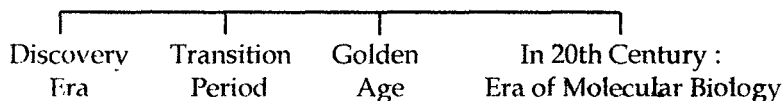

DISCOVERY ERA

This period concerns with the discovery of microbial world that has been dominated by Antony Van Leeuwenhoek

Antony Van Leeuwenhoek (1632-1723) of Delft, Holland (Netherland) was the first person to observe and accurately describe microorganisms (bacteria and protozoa) called 'animalcules' (little animals) in 1676. Actually he was a Dutch linen merchant but spent much of his spare time constructing simple microscopes composed of double convex lenses held between two silver plates. He constructed over 250 small powerful microscopes that could magnify around 50-300 times. Leeuwenhoek was the 1st person to produce precise and correct descriptions of bacteria and protozoa using microscope he made himself. Because of this extraordinary contribution to microbiology he is considered as the "**Father of bacteriology and protozoology**". He wrote over 200 letters which was transmitted as a series of letters from 1674-1723 to Royal society in London during a 50 years period. He wrote four volumes of *Arcana Naturae opeet Beneficio Exquisite Simorum Microvopiorum Detecta*.

TRANSITION PERIOD

Although, there were a number of significant developments in microbiology during Van Leeuwenhoek's time, Peoples were interested to correlate diseases with microbes. The main aspects were to solve the controversy over spontaneous generation which includes experimentations mainly of Francesco Redi, John Needham, Lazzaro Spallanzani and Nicolas Appert etc and to know the disease transmission which mainly includes the work of Ignaz Semmelweis and John Snow.

Francesco Redi (1626-1697): The ancient belief in spontaneous generation was first of all challenged by Redi, an Italian physician, who carried out a series of experiments on decaying meat and its ability to produce maggots spontaneously. Redi was the first who put the theory of spontaneous generation to test by conducting a simple experiment in which he placed meat in three jars. One jar was covered with fine gauze, second was covered with paper and third was left uncovered. Flies entered the jar that was open to air i.e. left uncovered and landed on meat where they laid their egg that later developed into maggots. The other two pieces of meat did not produce maggots spontaneously. However flies were attracted to the gauze covered jars and laid their eggs on the gauze and maggots subsequently developed without access to the meat, indicating that maggots were the offspring of the flies and did not arise from some 'vital source' in the meat as previously believed.

John Needham (1713-1781): He was probably the greatest supporter of the theory of spontaneous generation. He proposed that tiny organisms the animalcules arose spontaneously on his mutton gravy. He covered the flasks with cork as done by Redi and even heated some flasks. Still the microbes appeared on mutton broth.

Lazzaro Spallanzani (1729-1799): He was an Italian Naturalist who attempted to refute Needham's experiment. He boiled beef broth for longer period, removed the air from the flask and then sealed the container. Followed incubation no growth was observed by him in these flasks. He showed that the heated nutrients could still grow

animalcules when exposed to air by simply making a small crack in the neck. Thus Spallanzani disproved the doctrine of spontaneous generation.

Nicolas Appert followed the idea of Spallanzani's work. He was a French wine maker who showed that soups and liquids can be preserved by heating them extensively in thick champagne bottles.

Ignaz Semmelweis and John Snow were the two persons who showed a growing awareness of the mode of disease transmission.

Two German scholars Schulze (1815-1873) and Theodor Schwann (1810-1882) viewed that air was the source of microbes and sought to prove this by passing air through hot glass tubes or strong chemicals into boiled infusions in flasks. The infusion in both the cases remained free from the microbes.

George Schroeder and Theodor Von Dusch (1854) were the first to introduce the idea of using cotton plugs for plugging microbial culture tubes.

Darwin (1859) in his book, 'Origin of the Species' showed that the human body could be conceived as a creature susceptible to the laws of nature. He was of the opinion that disease may be a biological phenomenon, rather than any magic.

TABLE 1

Historical Development in the Field of Microbiology

1220-1252	- Rogen Bacon, disease produced by invisible living creatures.
1546	- Girolamo Fracastoro, disease was caused by minute 'seed' or 'germ's spread from person to person.
1658	- Athanasius Kircher, 1 st recognize the significance of bacteria and other microbes in disease.
1665	- Robert Hooke, referred as 'cells'.
1668	- Franceso Redi, demonstrate the fallacies in the spontaneous generation theory.
1676	- Antony Van Leeuwenhoek discovers 'animalcules'.
1688	- Redi Publishes work on spontaneous generation of maggot.
1776	- Lazzaro Spallanzani conducts experiment that dispute spontaneous generation.
1786	- Muller produces first classification of bacteria.
1798	- Edward Jenner introduces Cowpox vaccination for small pox.
1799	- Spallanzani attacks on the theory of spontaneous generation.
1839	- Theodor Schwann (german zoologist) and Mathias Schleiden (botanist) formulate the cell theory.
1857	- Pasteur shows that lactic acid fermentation is due to a microorganism.
1858	- Rudolf virchow, (all cell originate from pre existing cells).

-
- 1861 - Pasteur shows that microorganism do not arise by spontaneous generation.
 - 1867 - Lister publishes his work on antiseptic surgery.
 - 1869 - Johann Meischer discovers nucleic acids.
 - 1876-77 - Koch demonstrate that anthrax is caused by *Bacillus anthracis*.
 - 1881 - Koch cultures bacteria on gelatin.
 - 1882 - Koch discovers tubercle bacillus.
 - 1884 - Koch 's postulates first published.
Metchinikoff describes phagocytosis.
Autoclave developed.
Gram stain developed.
 - 1885 - Pasteur develops rabies vaccine.
 - 1887 - Petridish developed by Richard Petri.
 - 1892 - D. Ivanovski provides evidence for virus causation of T.M.V.
 - 1897 - Ross shows that malaria parasite is carried by the mosquito.
 - 1899 - Beijerinck proves that a virus particle causes the T.M.V.
 - 1906 - August Wasserman develops the first serologic test for syphilis.
 - 1908 - Paul Ehrlich becomes the pioneer of modern chemotherapy to treat syphilis.
 - 1910 - Frances Rous discovers viruses that can induce cancer.
 - 1915-17 - F.D. Herelle and F.Twort independently discover bacterial viruses.
 - 1923 - First edition of Bergey's manual.
 - 1928 - Griffith discovers bacterial transformation.
 - 1929 - A. Fleming discovers penicillin
 - 1935 - Stanley crystallizes the T.M.V.
 - 1944 - Avery shows that DNA carries information during transformation.
Selman Waksman discovers streptomycin.
 - 1946 - Lederberg and Tatum describe bacterial conjugation.
 - 1952 - Hershey and Chase show that bacteriophage inject DNA into host cells.
Zinder & Lederberg discover generalized transduction.
 - 1953 - Watson & Crick propose the double helix structure for DNA.
 - 1954 - Jonas Salk develops the first polio vaccine.
 - 1957 - Isaacs and Lindenmann discover the natural antiviral substance, Interferon.
 - 1958 - Lederberg makes discoveries concerning genetic recombination and the organization of the genetic material of bacteria.
-

1959	- Korenberg & Ochoa awarded nobel prize for the discovery of enzyme which produces artificial DNA and RNA.
1966	- Rous discovered tumor inducing viruses.
1971	- T.O. Diemer identifies viroids.
1975	- Kohler & Milstein develop technique for the production of monoclonal antibodies.
1977	- Recognition of archaeobacteria as distinct microbial group.
1979	- Henle identified first virus regularly associated with human cancer and insulin synthesized using rDNA techniques.
1982	- Recombinant Hepatitis B vaccine developed.
1982-83	- Cech and Altman discovered catalytic RNA.
1983-84	- Gallo and Montagnier isolated and identified HIV virus and PCR chain reaction developed by Mullis.
1990	- First human gene therapy testing begun.
1995	- Lewis, Nusslein and Wieschans for the study of physiology of genetics of microbes.
1997	- Prussiner discovery of prions.

GOLDEN AGE OF MICROBIOLOGY

The Golden age of microbiology began with the work of Louis Pasteur and Robert Koch who had their own research institute. More important there was an acceptance of their work by the scientific community throughout the world and a willingness to continue and expand the work. During this period, we see the real beginning of microbiology as a discipline of biology.

Louis Pasteur : Pasteur a French microbiologist, performed a series of experiments to prove that microorganisms were present in the air and were not spontaneously produced. He filled several round bottomed flasks with nutrient solution and fashioned their openings into elongated, swan neck shaped tubes. The flask's opening were freely open to the air but curved so that gravity would cause any air borne dust particle to deposit in the lower parts of the neck. The flasks were heated to sterilize the broth and then incubated. No growth occurred even though the contents of the flasks were exposed to the air. Pasteur pointed out that no growth took place because dust and germs had been trapped on the walls of the curved necks but if the necks were broken off so that dust fell directly down into the flask, microbial growth commenced immediately. Some of these ingenious little flasks are still on display at the Pasteur Institute in Paris in their original sterile form. This experiment clearly showed that microorganisms present on or in non-living materials such as dust or water were responsible for the contamination of sterile solutions. Pasteur, thus in 1861 finally

resolved the controversy of spontaneous generation versus biogenesis and proved that microorganisms are not spontaneously generated from inanimate matter but arise from other microorganisms.

Louis Pasteur, a professor of chemistry at the University of Lille, France. He was responsible for saving a principal industry of France i.e. manufacture of wine and beer. He found that fermentation of fruits and grains, resulting in alcohol, was brought about by microbes and also determined that bacteria were responsible for the spoilage of wine during fermentation. Pasteur in 1897 suggested that mild heating at 62.8°C (145°F) for 30 minutes rather than boiling was enough to destroy the undesirable organisms without ruining the taste of the product, the process was called Pasteurization. Pasteurization was introduced into the united states on a commercial basis in 1892. His work led to the development of the germ theory of disease.

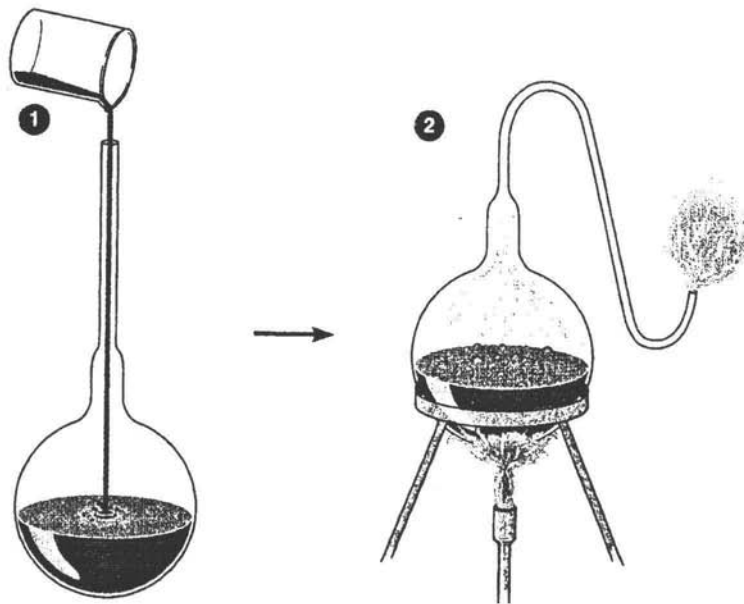

Fig. 1 : Photograph Pasteur's experiment disproving theory of spontaneous generation

John Tyndall (1820 - 1893): An English physicist, dealt a final blow to spontaneous generation in 1877. He conducted experiments in an aseptically designed box to prove that dust indeed carried the germs. He demonstrated that if no dust was present, sterile broth remained free of microbial growth for indefinite period even if it was directly exposed to air. He discovered highly resistant bacterial structure, later known as endospore, in the infusion of hay. Prolonged boiling or intermittent heating was necessary to kill these spores, to make the infusion completely sterilized, a process known as Tyndallisation.

Lord Joseph Lister (1827-1912): a famous English surgeon is known for his notable contribution to the antiseptic treatment for the prevention and cure of wound infections. Lister concluded that wound infections too were due to microorganisms. In 1867, he

developed a system of antiseptic surgery designed to prevent microorganisms from entering wounds by the application of phenol on surgical dressings and at times it was sprayed over the surgical areas. He also devised a method to destroy microorganisms in the operation theatre by spraying a fine mist of carbolic acid into the air, thus producing an antiseptic environment. Thus Joseph Lister was the first to introduce aseptic techniques for control of microbes by the use of physical and chemical agents which are still in use today. Because of this notable contributions, Joseph Lister is known as the **Father of Antiseptic surgery**.

Robert Koch (1893-1910) gave the first direct demonstration of the role of bacteria in causing disease. He was a German physician who first of all isolated anthrax bacillus (*Bacillus anthracis*, the cause of anthrax) in 1876. He perfected the technique of isolating bacteria in pure culture. He also introduced the use of solid culture media in 1881 by using gelatin as a solidifying agent. In 1882 he discovered *Mycobacterium tuberculosis*. He proposed Koch postulate which were published in 1884 and are the corner stone of the germ theory of diseases and are still in use today to prove the etiology (specific cause) of an infectious disease. The postulates are:

1. The suspected microorganism must always be found in diseased but never in healthy individuals.
2. The microorganism must be isolated in a pure culture (one free of all other types of microbes) on a nutrient medium.
3. The same disease must result when the isolated microorganism is inoculated into a healthy host.
4. The same organism must be reisolated from the experimentally infected host.

Although viruses and a few other microbes cannot be cultured in artificial media, Koch's postulates are still used today for the cause of most infectious diseases.

Robert Koch also used gelatin to prepare solid media but it was not an ideal solidifying agent because of the two important reasons (i) since gelatin is a protein, it is digested by many bacteria capable of producing a proteolytic exoenzyme gelatinase that hydrolyses the protein to amino acids and (ii) It melts when the temperature rises above 25°C. R. Koch will be remembered for both i.e. his contribution in the discovery of important disease producing microorganism and his fundamental contribution to bacteriological techniques.

Fanne Eilshemius Hesse (1850 - 1934) one of Koch's assistant first proposed the use of agar in culture media. Agar was superior to gelatin because of its higher melting (i.e. 96°C) and solidifying (i.e. 40-45°C) points than gelatin and was not attacked by most bacteria. Koch's another assistant Richard Petri in 1887 developed the Petri dish (plate), a container used for solid culture media. Thus contribution of Robert Koch, Fannie Fannie Hesse and Richard Petri made possible the isolation of pure cultures of microorganisms and directly stimulated progress in all areas of microbiology.

Edward Jenner (1749-1823) an English physician was the first to prevent small pox. He was impressed by the observation that countryside milk maid who contacted cowpox (Cowpox is a milder disease caused by a virus closely related to small pox) while milking

were subsequently immune to small pox. On May 14th, 1796 he proved that inoculating people with pus from cowpox lesions provided protection against small pox. Jenner in 1798, published his results on 23 successful vaccinators. Eventually this process was known as vaccination, based on the latin word 'Vacca' meaning cow. Thus the use of cow pox virus to protect small pox disease in humans became popular replacing the risky technique of immunizing with actual small pox material.

Jenner's experimental significance was realized by Pasteur who next applied this principle to the prevention of anthrax and it worked. He called the attenuated cultures vaccines (Vacca = cow) and the process as vaccination. Encouraged by the successful prevention of anthrax by vaccination, Pasteur marched ahead towards the service of humanity by making a vaccine for hydrophobia or rabies (a disease transmitted to people by bites of dogs and other animals). As with Jenner's vaccination for small pox, principle of the preventive treatment of rabies also worked fully which laid the foundation of modern immunization programme against many dreaded diseases like diphtheria, tetanus, pertussis, polio and measles etc.

Elie Metchnikoff (1845-1916) proposed the phagocytic theory of immunity in 1883. He discovered that some blood leukocytes, white blood cells (WBC) protect against disease by engulfing disease causing bacteria. These cells were called phagocytes and the process phagocytosis. Thus human blood cells also confer immunity, referred to as cellular immunity.

Emile Roux (1853-1933) and Alexandre Yersin, the two notable French bacteriologists demonstrated the production of toxin in filtrates of broth cultures of the diphtheria organism. Emil von Behring (1854 -1917) and Shibasaburo Kitasato (1852-1931) both colleagues of Robert Koch, in 1890 discovered tetanus (lock jaw) antitoxin. Only about a week after the announcement of the discovery of tetanus antitoxin, Von Behring in 1890 reported on immunization against diphtheria by diphtheria antitoxin. The discovery of toxin-antitoxin relationship was very important to the development of science of immunology.

While all these milestones were being laid in the field of microbiology, an English surgeon, Joseph Lister (1827-1912) was trying to combat the microbes that caused post operative and wound infection disaster searched for a way to keep bacteria out of wounds and the incisions made by surgeons. He used a dilute solution of carbolic acid to soak surgical dressings that kept the wounds free from microbial infection and healing took place rapidly. So remarkable was his success that the technique was quickly accepted and the principle of present day aseptic technique was established.

Paul Ehrlich (1854-1915) in 1904 found that the dye Trypan Red was active against the trypanosome that causes African sleeping sickness and could be used therapeutically. This dye with antimicrobial activity was referred to as a 'magic bullet'. Subsequently in 1910, Ehrlich in collaboration with Sakahiro Hata, a Japanese physician, introduced the drug Salvarsan (arsenobenzol) as a treatment for syphilis caused by *Treponema pallidum*. Ehrlich's work had laid important foundations for many of the developments to come and the use of Salvarsan marked the beginning of the era of chemotherapy and the use of chemicals that selectively inhibit or kill pathogens without causing damage to the patient.

Gerhard Domagk of Germany in 1935 experimented with numerous synthetic dyes and reported that **Prontosil**, a red dye used for staining leather, was active against pathogenic, *Streptococci* and *Staphylococci* in mice even though it had no effect against that same infectious agent in a test tube. In the same year two French scientists **Jacques** and **Therese Trefonel** showed that the compound **Prontosil** was broken down within the body of the animal to **sulfanilamide** (Sulfa drug) the true active factor. **Domagk** was awarded nobel prize in 1939 for the discovery of the first sulpha drug.

The credit for the discovery of first 'wonder drug' **penicillin** in 1929 goes to **Sir Alexander Fleming** of England, a Scottish physician and bacteriologist. Fleming had been actually interested in searching something that would kill pathogens ever since working on wound infections during the first world war (1914-1918). One day in 1928 upon his return from a week's vacation, Fleming observed that a plate of *Staphylococcus aureus* had become contaminated with a green mold *Penicillium notatum* which had accidentally fallen in plate. Observing this plate, Fleming noted that the colonies of *Staphylococcus* bacterium were evidently being destroyed by the nearby *Penicillium* colonies. Rather than discarding the contaminated plate, he speculated that the mold was producing a diffusible substance that inhibited the bacterial growth. Fleming isolated and subcultured the mold for further study. He extracted from the fungus a compound which he called **penicillin**, after the name of the producer organism *Penicillium notatum*, that could destroy several pathogenic bacteria. Thus, **Sir Alexander Fleming** in 1929 discovered the first antibiotic (Gr. Anti = against + bios = life, the microbial products that can kill susceptible microorganism and inhibit their growth) **penicillin**. The commercial production of **penicillin** in the USA began in 1941 **Fleming**, **Florey** and **Chain** shared the nobel prize in 1945 for the discovery and production of **penicillin**. *Penicillium notatum* has been replaced with *Penicillium chrysogenum* for the commercial production of **penicillin** and the current strain of this species modified through mutation, yields 85,000 units/ml of medium (the original mold. *P. chrysogenum* synthesized 60 units/ml. **Waksman** at the Rutgers university, USA discovered another antibiotic, **streptomycin** produced by two strains of actinomycete, *Streptomyces griseus* in 1944. **Waksman** received the noble prize in 1952 for his discovery of **Streptomycin** used in the treatment of tuberculosis, a bacterial disease caused by *Mycobacterium tuberculosis* that had been discovered by **Robert Koch** in 1882. By 1950, three other microorganism were identified that produced antibiotics, such as **chloramphenicol** (Chloromycetin) from *Streptomyces venezuelae* by **Dr. Paul R. Burkholder** in 1947, **Aureomycin** from *S. aureofaciens* by **Dr. B.M. Dugger** in 1948; and **Terramycin** from *S. rimosus* by **Finlay, Hobby** and collaborators in 1950.

A dramatic turn in microbiology research was signaled by the death of **Robert Koch** in 1910 and advent of world war I. The Pasteur Institute was closed, and the german laboratories converted for production of blood components used to treat war infections. Thus came to an end what many have called the **Golden Age of Microbiology**.

IN 20th CENTURY: ERA OF MOLECULAR BIOLOGY

By the end of 1900, science of microbiology grew up to the adolescence stage and had come to its own as a branch of the more inclusive field of biology. In the later

years the microorganism were picked up as ideal tools to study various life processes and thus an independent discipline of microbiology, molecular biology was born. The relative simplicity of the microorganism, their short life span and the genetic homogeneity provided an authentic simulated model to understand the physiological, biochemical and genetical intricacies of the living organisms. The use of microorganisms as a tool to explore fundamental life processes became attractive due to the following facts:

1. They reproduce (grow) very rapidly.
2. Can be cultured in small and vast quantities conveniently and rapidly.
3. Their growth can be manipulated easily by physical and chemical means and their cells can be broken apart or the contents can be separated into fractions of various particle sizes. Because of these characteristics microorganisms were used as research models to determine exactly how various life processes take place in terms of specific reactions and the specific structures involved.

The list of those who contributed to the development of microbiology is far too long to recite here in its entirety. Here we shall highlight briefly only few of the important microbiological accomplishments.

George W. Beadle and Edward L. Tatum both US Scientists, were the pioneers in the area of microbial genetics. They studied the relationship between genes and enzymes in 1941 using mutants of the bread mold fungus, *Neurospora crassa* and gave the concept of one-gene –one enzyme hypothesis. Using mutants of *Neurospora*, they demonstrated that there was a direct relationship between a single gene and a single enzyme. Beadle and Tatum hypothesized that the synthesis of the compounds essential for cell growth must be under genetic control. They also concluded that a defect in one gene produced a single defect in an essential enzyme resulting in the growth factor requirement, that is one gene one – enzyme theory. Lederberg, Beadle and Tatum were awarded the nobel prize in 1958 for the discovery of one gene one enzyme hypothesis.

Max Delbruck and Salvatore Luria in 1943 described the genetic nature of viruses. They also proved that gene mutations were truly spontaneous and not directed by the environment. DNA is the genetic material and carried genetic information during transformation in bacteria was demonstrated in 1944 by Oswald, T. Avery, Colin. M. Maclead and Maclyn McCarty. In 1952 Joshua Lederberg first of all introduced the term 'Plasmid' to describe nonchromosomal genetic material in bacteria. In collaboration with Norton Zinder, a student in his laboratory at Wisconsin, USA, Lederberg discovered that genetic information could be transferred between bacteria by bacteriophage this process was known as transduction. Lederberg along with his wife Esther, developed a unique method of studying bacterial mutants, now known as 'replica plating' using this method it is possible to transfer bacterial colonies from one agar growth plate to other so that each new plate is an exact replica of the original. With this technique, Lederberg showed that mutations in bacteria occur randomly and spontaneously. Thus discovery made by Lederberg in bacterial genetics – transduction and conjugation in bacteria have made the science of bacterial genetics and have subsequently spawned many advances including aspects of modern molecular genetics of gene cloning. Thus J. Lederberg single handedly changed the nature of bacterial genetics and biochemistry.

Watson and Crick in 1953 made most remarkable discovery in genetics by discovering the molecular structure of DNA providing framework for understanding molecular basis of inheritance and expression of genetic information. Ochoa and Kornberg isolated and synthesized the enzyme, responsible for production of ribonucleic acids, RNA and DNA that carry hereditary information for which they received nobel prize in 1959.

In 1968, the nobel prize for physiology and medicine was shared by Robert W. Holley, Hargovind Khorana and M.W. Nirenberg for their contribution to the understanding of the genetic code and its function in protein synthesis. The 1969 nobel prize in medicine and physiology was awarded to Max Dalbruck, Alfred D. Hershey and S.E. Luria for studying the replication mechanism and genetic structure of bactriophage. Albert Claude, G.E. Palade, Christian D. Duve jointly received the prestigious nobel prize of 1974 for the isolation of cell parts in order to study the structure and chemistry of individual cell which led to the discoveries of ribosome and lysosome. In the following year, 1975 R. Dulbecco, H.M. Temin and David Baltimore of U.S.A. were awarded the nobel prize for researching the interaction between tumor virus and genetic material of the cell. In 1976, Gajdusek and Blumberg did research leading to nobel prize for a test to show hepatitis virus in donated blood and to a experimental vaccine against the disease. Two years later, Arber, Smith and Nathans were jointly awarded this prize for discovery of restriction enzyme and their application to the problems of molecular genetics.

A number of nobel laureates in medicine and physiology awarded the nobel prize for their work in microbiology.

TABLE 2
Nobel Laureates in Microbiology

Year	Nobel laureate	Research work
1901	Emil A. Von Behring	Serum therapy against diphtheria (developed antitoxin)
1902	Sir Ronald Ross	Malaria parasite- life cycles in mosquitoes.
1905	Robert Koch	Tuberculosis- discovery of causative agent.
1907	C.L.A. Laveran	Discovery of malaria parasite in an unstained preparation of fresh blood.
1908	Paul Ehrlich and Elie Metchnikoff	The first selective theory of antibody formation. Defined role of phagocytes in immunity, developed first theory of cellular immunity.
1913	Charles Richet	Discovered and characterized nature of anaphylaxis.
1919	Jules Bordet	Discovered roles of complement and antibody in cytolysis, developed complement fixation test.
1928	Charles Nicolle	<i>Typhus exanthematicus</i>
1930	Karl Landsteiner	Described ABO blood groups; solidified chemical basis for antigen-antibody reactions.

Contd...

...Contd.

Year	Nobel laureate	Research work
1939	Gerhardt Domagk	Antibacterial effect of prontosil
1945	Sir Alexander Fleming,	Sir Howard Florey and E.B. Chain Discovery of miracle drug 'penicillin', and its broad spectrum antibacterial action.
1952	Selman A. Waksman	Development of streptomycin. He coined the term 'antibiotic'.
1954	J.F. Enders, F.C. Robbins and T.H. Weller	Cultivation of polioviruses in non-neural cells of human embryos demonstrating cytopathic effect.
1958	G.W. Beadle, Joshua Lederberg and E.L. Tatum	Genetic mechanisms Transmission of hereditary characteristics
1960	Sir Macfarlane Burnet and Sir Peter Brian Medawar	Postulated clonal selection theory of antibody formation. Proved immunological basis for mammalian allograft rejection; contributed to elucidation of induced immunological tolerance.
1962	Watson and Crick	Double helix structure of deoxyribonucleic acid (DNA)
1965	Francois Jacob, Andre Lwoff and Jacques Monod	Regulatory mechanisms in microbial genes (concept of 'lac operon').
1966	Peyton Rous	Viral oncogenesis (avian sarcoma)
1968	Holley, Khurana and Nirenberg	Genetic code
1969	Max Delbruck, A.D. Hershey and Salvador Luria	Mechanisms of virus infection in living cells.
1972	Gerald Edelman and Rodney Porter	Structure and chemical nature of antibodies.
1975	David Baltimore, Renato Dulbecco and Howard M. Temin	Interactions between tumor viruses and genetic material of the cells.
1976	Baruch S. Blumberg and Carleton Gajdusek	New mechanisms of origin and dissemination of infectious diseases.
1977	Rosalyn Yalow	Developed and defined radioimmunoassay.
1980	Baruj Benacerraf,	Identified immune response genes.

Contd...

...Contd.

Year	Nobel laureate	Research work
	Jean Dausset and George Snell	Described analogies between mouse and human histocompatibility system.
1984	Cesar Milstein and Georges Kohler Beils Jerne	Developed hybridoma technology for production of monoclonal antibodies. Described biological selection theory of antibody formation and also accounted for immunological tolerance.
1987	S. Tonegawa	Elucidated nature of antibody diversity in terms of recombination of C,V and J genes.
1989	J. Michael Bishop and Hanold E. Varmus	Identified first cellular oncogenes and initiated studies characterizing their role in cellular function.
1990	J. Murray and E.D. Thomas	Performed first successful transplant of living donor kidney to a host. Pioneered procedures for chemical management of graft-versus-host disease in tissue organ transplantation
1993	Kary Mulis	Polymerase chain reaction
1996	Peter C. Doherty, Rolf M. Zinkernagel	Cell mediated immune defences
1997	Stanley B. Prusiner	Prion discovery

It is evident from the history of microbiology that it is an unfinished epistolary record. The secret of nature always allures the genius and it is the inquistiveness of man that prompts him to lay the milestones to unfold the facts of life with the help of these tiny organisms. The significance of these discoveries in molecular biology to biology is understood by the fact that about 1/3 of Nobel prizes have been awarded to researches for their work in the area of microbiology.

□□□

EVOLUTION OF MICROORGANISM

Evolution means an unfolding or unrolling a gradual or orderly change from one condition to another. The planets and stars, the earth's topography the chemical compounds of the universe and chemical elements and their sub-atomic particles have undergone gradual and orderly changes is termed as inorganic evolution. The term organic evolution states that all the various plants and animals existing at present time have descended from other generally the simpler organism by gradual modification which have accumulated in successive generations. The major trend in the evolution is been towards increased adaptation to some particular environment, and this has frequently involved increased specializations and complexity of structures and their functions.

Life originated on earth millions of years ago and since then innumerable varieties of living beings have evolved but this living matter cannot have existed all the time, on the earth. The high temperature and dry climate of the early time of earth would have made living matter impossible to exist.

The origin of life on earth occurs in following three steps:

(A) ORIGIN OF UNIVERSE

Man has been speculating on the origin of the earth for thousands of years. Certain elaborate hypothesis of earth origin have played a significant role in the development of geologic theory regarding the origin of universe as well as earth. The various hypothesis proposed are as follows:

1. The Nebular hypothesis - given by Immanuel Kant (1755) and Pierre Simon de laplace (1796)

2. The Planetesimal hypothesis - given by Thomas. C. Chamberlin and Forest. R. Moulton (1895)
3. The Tidal hypothesis - James Jeans and Harold Leffries (1917)
4. Recent hypothesis

1. The Nebular Hypothesis

The nebular hypothesis of Kant and Laplace is referred to as a star hypothesis.

The hypothesis postulates that a greatly diffused spherical cloud of gas a nebula, extended outward at least to the present distance of the outer most planet. This cloud rotated slowly as it cooled and contracted its velocity around the sun increased. The gaseous mass gradually became a disk around the sun's equator during this rotation, rings of fiery gas were assumed to have been thrown off centrifugal force. Each ring than broke up and gathered into a sphere producing a planet which began to revolve around the sun the same path as the former ring. The earth planet liquefied as it cooled, then with further cooling acquired a solid crust. The main body of the gas mean while condensed further to become the sun.

The serious objections to the nebular hypothesis are:

1. The planets possess 98% of the rotational energy of the solar system, whereas the sun has about 99.87% of the mass.
2. The heavy elements in the earth can originate only at temperatures for higher than those prevailing on the sun.
3. Some of the satellites revolve in a backward direction and one of them revolves faster than its planet rotates.
4. The mechanism of ring formation does not correspond to rotational velocity of a solar nebula as postulated.

2. The Planetsimal Hypothesis

The planetesimal hypothesis of Chamberlain and Moulton is referred to as a two star hypothesis. It explains the origin of the planets by a near collision between the sun and another star which disrupted it. This hypothesis has many serious objections.

3. The Tidal Hypothesis

This hypothesis proposed by James Jeans and Harrold Leffries (1917) proposed that another star closely approached the sun, producing tidal buldges from which steamed an enormous cigar shaped filament of solar gases. This incandescent filament was put into revolution around the sun. It then broke into segments which contracted into rotating spheres, the planets cooling from gas to liquid one of these planets, earth gradually solidified to its present condition.

4. Recent Hypothesis

With the development of new mathematical technique and the discovery of new

facts about the universe, various cosmogonist viz. Berlage (1940), Whipple (1947) and Hoyle (1950) has proposed new hypothesis. The general trend is toward a modified version of the ancient nebular hypothesis.

According to nebular hypothesis about 10-20 billion yrs ago, cosmos was in the form of a small sphere of highly condensed mass of cosmic material, with a big bang it exploded into numerous pieces called nebulae. Our solar system originated from one of these nebulae. The nebula was a cold and spinning cloudy mass of cosmic dust or gases. The central mass of nebula condensed to form a primitive sun. As it condensed, the sun became hotter and brighter due to the conversion of gravitational energy into heat. Higher temperature initiated thermonuclear reaction in the sun which then started emitting solar radiation.

Because of rotational movement of nebula, a ring of cloud got separated, spinning around the central mass and condensed into planets including our earth. As the earth was formed by the condensation of nebular mass, its temperature increased due to internal pressure, gravitation and effect of solar heating.

Thus initially the earth was a fiery spinning ball of hot gases and vapours of various elements. Through hundreds, millions years, the gases condensed into a molten core and different elements got stratified according to their density. The heavy elements like iron and nickel etc, sank to the centre and formed solid core of the earth, the lighter elements like silicon and aluminum rose to the surface and solidified to form the surface or crust. The part of the earth between core and crust formed mantle which is solid and made up of iron, magnesium and silicates.

The lightest ones like He, H, O₂, N₂ and C flowed out of the surface and formed the gaseous atmosphere.

The Primitive Atmosphere of Earth

The original temperature of earth was supposed to be 900°C initially. This temperature was such high that the elements like H₂, N₂, O₂, and C could not exist in free state. These gases combined variously either among themselves or with metals forming oxides, carbides and nitrides. Thus carbon formed dicarbon, cyanogens, methane, CO₂, CO and metal carbides. Nitrogen formed nitrides with metals, oxygen formed oxides and H₂ combined with O₂ to form water, with N₂ to form ammonia, methane and carbon cyanamide with carbon.

Initially the temperature was too high that all these compound existed in gaseous state and water as superheated steam. These formed the atmosphere of primitive earth. This atmosphere of primitive earth was unlike our present atmosphere in following respects:

1. **Abundance of H₂** : The interstellar dust from which earth originated was especially rich in H₂. It readily combined with N₂ forming ammonia, with O₂ to form water and methane with carbon. The primitive earth atmosphere was highly reducing.

2. **Absence of O₂** : The atmosphere of primitive earth was non-oxygenic. The free oxygen was bound in water, CO, and CO₂ and in metallic oxides on the surface rocks and particles. Because of the absence of free O₂ and complex organic compound that arose during early time were not subjected to degradation.

3. Absence of ozone layer : There was no layer of ozone to absorb UV rays coming on earth from sun.

Later the earth cooled gradually, some of the atmospheric gas liquefied, and some of the liquid turned solid. Steam condensed into water and resulted into rain. The rain droplets on approaching the super heated earth crust immediately evaporated and returned into the atmosphere. This cycle continued for millions of years and resulted in the cooling of earth surface. As a result the earth surface became cool enough to hold water and large water bodies/first oceans come into existence. About 3 billion yrs ago the earth had a solid crust, frequently punctured by eruptions of molten rocks (Volcanoes) and at places filled with hot boiling sea water. The sea water contained dissolved NH_3 , methane, some minerals and salts. The primitive atmosphere of the earth was devoid of free oxygen but rich in NH_3 , CH_4 and hydrogen as found in the present atmosphere of Jupiter, Saturn, Uranus and Neptune.

The energy for synthetic processes that occurred on primitive earth in past during chemical evolution was obtained from the following sources:

- (a) Solar radiation or UV radiation from sun formed the most abundant type of free energy available on primitive earth.
- (b) Violent electric discharge followed with lightening and thunder from clouds reached the primitive earth and contributed significantly to form various micro and macro-molecules.
- (c) Volcano eruptions produced heat which also encouraged chemical reactions.
- (d) Ionizing radiations and cosmic rays i.e. x - rays etc also provided energy for chemical evolution.

(B) CHEMICAL ORIGIN OF LIFE (CHEMOGENY)

Life did not originate at one specific spot at one specific time in the early oceans of earth. Oparin suggested that from these simple compound viz. (H_2O , CH_4 , NH_3 , Nitrogen formed nitrides, oxides, dicarbon, CO_2 and CO) more and more complex organic compounds were formed gradually under the influence of electric charges, UV rays or corpuscular radiations.

Step-1 : Origin of organic compounds.

Step-2 : Formation of macromolecules or complex organic molecules by the process of polymerization and condensation.

Step-3 : Formation of nucleic acids

Step-4 : Formation of nucleoproteins or protobionts.

Step-1 : Origin of organic compounds

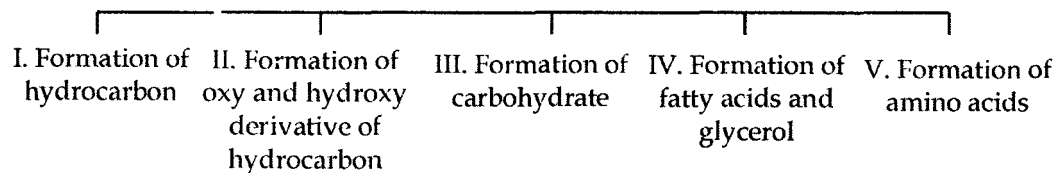

I. Formation of Hydrocarbons (Micro Molecules): When the temperature of earth cooled down to 1,000°C or even lower a variety of simple hydrocarbons (saturated/unsaturated) were formed presumably by the following methods:

The combination of highly reactive free radicals CH and CH₂

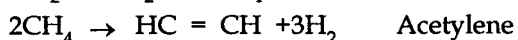
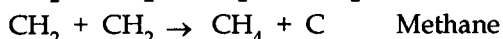
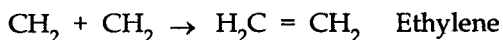
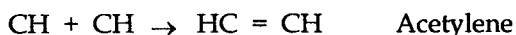

The metal carbides reacted with steam

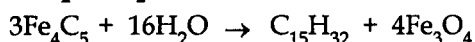
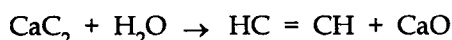

II. Formation of oxy and hydroxyl derivative of hydrocarbons: Both saturated as well as unsaturated hydrocarbons reacted with superheated steam and formed oxy and hydroxyl-derivatives such as aldehyde, ketone and acids.

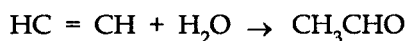

Carbon monoxide reacted with water forming formic acid. Because of its reactivity carbon monoxide is considered to have participated in the formation of prebiotic compounds.

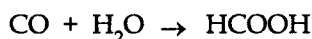

III. Formation of carbohydrate: Small chain compounds of C, H, O were also formed from hydroxy derivatives. The first formed carbohydrate compound must have been glucose and fructose. They condensed to form disaccharide and polysaccharide like sugars and starch.

IV. Formation of fatty acid and glycerol : The condensation and polymerization of aldehyde and ketones and their oxidation resulted in the formation of fatty acids. These compounds had lesser percentage of oxygen and long straight chains of carbon. In the early oceans these glycerol and fatty acids might have combined to form fats.

V. Formation of NH₂ acids : Combination of hydrocarbon, ammonia and water under the influence of freely available energy reacted to form amino compounds the amino acids.

Thus after the synthesis of carbohydrate, fats and amino acids and other complex organic substances probably occurred in sea, which according to Haldane is described as 'Hot dilute Soup'. The early ocean is considered to have been a primordial soup that contained all these building blocks of life. Life did not originate at one specific spot at one specific time in the early oceans of earth life originated again and again wherever necessary precursor accumulated.

Step-2 Formation of macromolecular or complex organic molecules by polymerisation and condensation

In the hot dilute soup the molecules of simple organic substances came together

in increasing number, collided, reacted and aggregated to form new molecules of increasing size and complexity resulting in the formation of more and more complex organic compounds like polysaccharide, fats, proteins, purines, pyrimidines, nucleosides and nucleotides. The process is called Polymerisation. Sugar molecules combined to form polysaccharide like starch, cellulose and glycogen. The fatty acid and glycerol combine to form fats. A large number of amino acid molecule combined to form long polypeptide chains. Some of these polypeptide acted as primitive enzymes and speeded up the rate of formation of specific molecules.

The presence of appropriate organic monomers and polymers is the first step in the origin of life. The interaction between molecules due to hydrogen bonding, ionization solubility, surface tension etc. resulted in different orientation of molecules. Membranous vesicles formed of lipids, polypeptides or other molecules can be produced by mechanical agitation or spontaneously. These membranous vesicles represented an important step in the origin of life because scientists were able to produce such simple structures in the laboratory viz. Coacervates and microspheres.

(a) **Coacervates** : Oparin and Fox found that large organic molecules synthesized abiotically on primitive earth formed large colloidal aggregates due to intermolecular attraction. These colloidal particles separate out of the solution into droplets called coacervates. Complex coacervates are made up of colloidal solution having more than one type of macromolecules.

When solutions of oppositely charged colloids are mixed coacervates droplets are formed. They have much higher concentration of organic polymers than in aqueous phase.

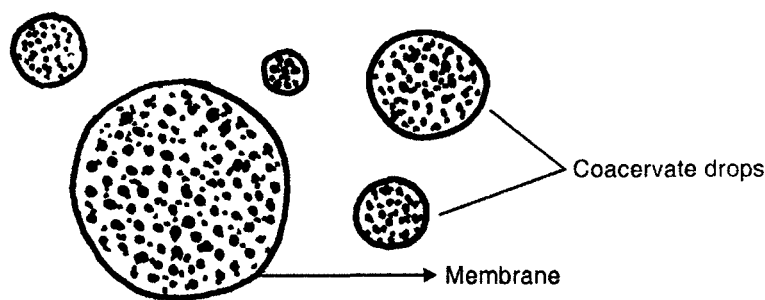

Fig. 1 : Coacervate

The Coacervates contain following characteristics :

- ❖ They are large enough to be seen under microscope.
- ❖ They have very simple organisation.
- ❖ They are mostly unstable, but some can stay for longer period.
- ❖ They can increase in size by selectively absorbing proteins and other organic material.

- ✧ They can divide by budding.
- ✧ They can carry out functions like synthesis and hydrolysis of starch and polynucleotides with the help of enzymes.

Along with these characteristic the coacervate also present as poor model for protocells because :

- ✧ They are formed from the mixture of contemporary bioproteins and not from the proteins that existed in past.
- ✧ They are unstable and disintegrate with time.

(b) Microspheres : Fox found that when thermally produced protenoid were boiled in water and allowed to cool, small spherical aggregates of protenoid are formed. These are called microspheres. They have following characteristics:

- ✧ They are easily formed when water is added to thermal proteinoids.
- ✧ Show great uniformity in size and shape.
- ✧ They resemble coccoid bacteria and generally form chains of varying length.
- ✧ Generally stable.
- ✧ E.M. of proteinoid microsphere reveal double layered boundary corresponding to cell membrane
- ✧ They exhibit nonrandom motility.
- ✧ They retain enzyme like activities of proteinoids.
- ✧ They divide either by binary fission or by budding.

On these basis it is assumed that microsphere like aggregates could have been the fore runners of first living organism. Thus they provide an excellent model for protocells because :

- ✧ Microsphere originated from protenoid produced under conditions existing on the primitive earth.
- ✧ They show structural and functional attributes of contemporary cells.

Step-3 : Formation of Nucleic Acids

The next step was formation of nucleic acids by the polymerization of nucleotides. These self-replicating polynucleotides (N. Acid) got established in the primordial earth about 3.5 billion yrs ago. Due to errors during replication different varieties of nucleic acids were formed. These molecules with different nucleotides sequences competed for the available nucleotides precursor for self duplication.

Certain polynucleotides developed the quality of directing synthesis of polypeptides. It is suggested that RNA was the first carrier of genetic information. This shows that the genetic code and translation of nucleotide sequences into - NH₂ acid sequences was established at a very early stage of organic evolution. The nucleic acids were like naked genes and their formation was the first step to enter the vaguely defined frontiers between life and non-life.

Step-4 : Formation of Nucleoproteins or Protobionts :

Due to aggregation, giant molecules of nucleoproteins were formed by the union of nucleic acid and basic protein molecules.

Protoribosomes : They were nucleoproteinoid particles with fibrous or globular appearance. The globular nucleoproteinoid microparticles might have been early ribosomes and called protoribosome.

Protoviruses : Some giant nucleoproteinoid molecules had certain characteristic of a free living gene. They were called protoviruses or protobionts by Oparin.

The coacervate underwent some chemical reactions which produced special proteins or enzymes. This led to self-replication of compounds, those possessing this property might be regarded as Freegene. Such a structure is comparable with the free living virus and is supposed to be, formed of nucleoproteins. Self replication and mutations of a gene lead to the formation of gene aggregates. These gene aggregates may be regarded as independently existing chromosomes. The smallest bacteria represent such a stage in its evolution.

Further mutation lead to accumulation of metabolites around the chromosome. The complex so formed represent the exposed nucleus. The cytoplasm might have been acquired but not separated from the nuclear material as in blue green algae or in large bacteria. Finally mutations led to the formation of typical cell with nuclear membrane.

(C) BIOLOGICAL EVOLUTION OR BIOGENY

There are two hypothesis regarding the origin of primitive prokaryotic cell:

(a) Horowitz (1945) and Orgel (1973) proposed that nucleoprotein molecules formed aggregates in the hot soup of primitive sea. These got surrounded by nutrient shells and limiting membrane and formed the first living cell.

(b) Oparin suggested that various macromolecules aggregated in the hot dilute soup to form coacervates which got isolated from the surrounding by the formation of polarized membrane of phospholipids. The coacervate with nucleoproteins developed into first living cells or protobionts. These first cells were similar to present day mycoplasma and viruses. After some later stage in the evolutionary process. DNA took the place of a repository of genetic information. These protobionts most probably gave rise to monera (cell without well defined nucleus) and Protista (cells with a distinct nucleus). The monera and protista gave rise to Prokaryote and eukaryote respectively. Monera developed into bacteria and cyanobacteria whereas Protista gave rise to eukaryote or that developed into Protozoa and Metaphyta.

The fossilized remains of prokaryotic cells are around 3.5 to 3.8 billion years old and have been discovered in stromatolites and sedimentary rocks and microbial fossil are clearly present in rocks as old as 2 billion years. The stromatolites are layered or stratified rocks often domed and are formed by incorporation of mineral sediments into microbial mats. Thus prokaryotic cells or life arose very shortly after the earth cooled. Very likely these early prokaryotes were anaerobic. The fossils of such primitive protobionts have been obtained from rocks in Africa about 3 billion yrs old. These were

named *Eobacterium isolatum*. The modern stromatolites are layered or stratified rocks formed by incorporation of calcium sulfate, calcium carbonate and other minerals into microbial mats.

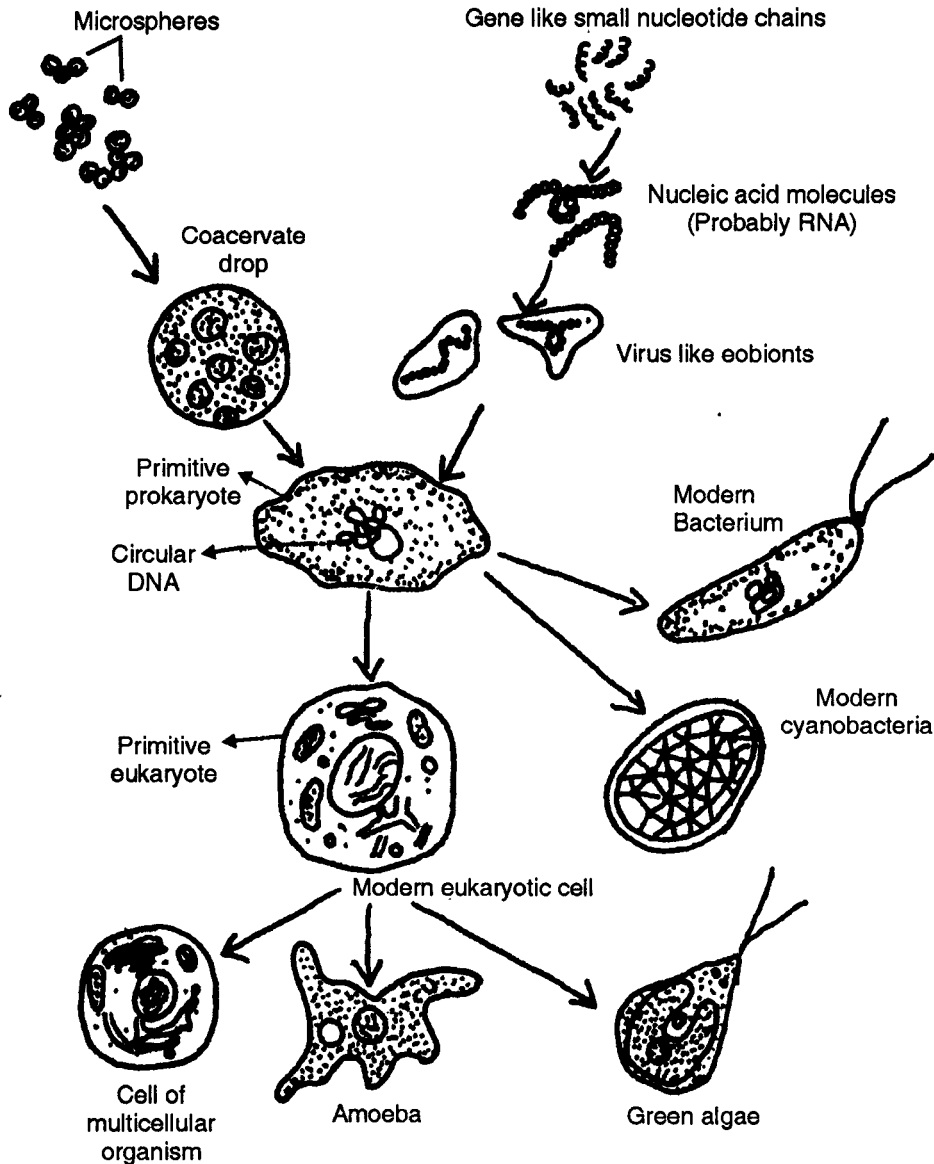

Fig. 2 : Biological evolution of life

Step-6 : Evolution of Modes of Nutrition

The next step in the evolution of life was the evolution of different mode of nutrition.

It is presumed that the first living organism or cell had obtained energy by the fermentation of complex organic substances available to them from the sea broth (the hot dilute soup) i.e. the organism were chemoheterotroph. With rapid increase in the number of chemoheterotroph, the nutrients from sea water began to disappear and gradually exhausted. This led to the evolution of other modes of nutrition like :

(a) **Parasitism** : This mode developed when some forms started living within the bodies of living cells and obtained their food from them Example : Moneran, Viruses and few protista are parasitic.

(b) **Saprophytism** : As the environment of primitive earth changed, some organism started drawing their nourishment from the bodies of dead and decaying cell.

(c) **Predation** : The predators were the organism with animal like way of eating where one organism eats another in whole or in part and obtains its food in this manner.

(d) **Chemoautotrophs**: Proto cells with enzymes of metabolic pathways could use less complex nutrients and synthesized more complex molecules. They obtained energy by fermentation. These early fermentative or anaerobic chemoautotrophs were similar to our present day anaerobic bacteria and yeast. These anaerobic bacteria released large amount of CO_2 . Thus they were forerunners of photosynthetic cells.

(e) **Chemosynthesisers** : In the next step the evolution of chlorophyll molecule enabled certain protocells to utilize light energy and synthetic carbohydrate. They were photosynthetic cells. The first photosynthetic cells were anaerobic, Example, the organism similar to present day sulphur bacteria. This was the beginning of autotrophism where the H_2S was cleaved into H_2 and S where H_2 was used in the synthesis of organic compound and sulphur released as waste product. These organism generate the energy released by anaerobic respiration or fermentation and were called chemosynthesisers.

(f) **Aerobic Photoautotroph** : The last organism with most advanced type of nutrition was Aerobic photoautotroph. It is presumed that accumulation of CO_2 in atmosphere and formation of chlorophyll molecule resulted in the evolution of autotrophic forms. The first aerobic photoautotroph were cyanobacteria like forms which used water as H_2 source and CO_2 as the source of carbon in photosynthesis. They were called oxygen producing phototransformers because of release of free oxygen in the atmosphere and are also called oxygen producing photosynthesisers. They appeared about 3.3 - 3.5 million yrs ago.

With the increase of photoautotroph, O_2 was liberated in the sea and then into atmosphere. This free oxygen then reacted with CH_4 and NH_3 present in the primitive earth and transformed them into CO_2 and free N_2 . These gradual events ultimately transformed this ancient reducing, O_2 free atmosphere into modern oxidizing atmosphere with plenty of oxygen. The rising level of atmosphere oxygen led to the appearance of first one called eukaryotic organism.

(D) COGNOGENY

The protocells were prokaryotic and archaebacteria like. The eukaryotic cells have evolved from the archaic prokaryotic cell either by symbiosis or by invagination.

According to Lynn Margulis, some anaerobic predator host cell engulfed primitive aerobic bacteria but did not digest them. The oxygen respiring bacteria established themselves permanently inside host cells and developed mutual association. These predator host cells become the first eukaryotic cells. The predators that captured aerobic bacteria developed as mitochondria while with blue green algae as chloroplast. This hypothesis is supposed as endosymbiont hypothesis.

Margulis and other have assembled a considerable amount of indirect evidence in support of this hypothesis like Mitochondria and chloroplast are similar to bacteria and cyanobacteria, they both contain self replicating DNA, ribosomes are similar like prokaryotic cell. The proponents of endosymbiotic hypothesis suggest that endosymbionts must have transferred over time, some of their genes to the host nucleus and thus relinquished their independence for the sake of symbiotic relationship

According to other view the organelles of eukaryotic cells might have evolved by invagination of surface membrane of primitive prokaryotic cells. The archaeobacteria are said to be the oldest of the 'living fossils' that had separated from the main moneran line (bacterial evolution) long ago. Regardless of the exact mechanism involved, the emergence of eukaryotic cell led to dramatic increase in the complexity and diversity of life on earth. At first organism were capable of existing only as independent single cells. Later some evolved into multicellular organism in which various cells became specialized for many different functions. The multicellular forms became adapted to life in a great variety of environments.

□□□

4

CLASSIFICATION OF MICROORGANISM

A classification system based on the scheme of assigning individuals to group and assigning these to progressively more inclusive and broader groups is called a hierarchical scheme of classification. The formal system of organizing, classifying and naming living things is called taxonomy (Gr. Taxis = arrangement + nomas = name). The primary goals of taxonomy are classification, nomenclature and identification. These three areas are interrelated and play a vital role in keeping a dynamic inventory of the extensive array of living things. Once the characteristics of microorganism is determined and appropriately catalogued the process of classification begins. The orderly arrangement of organisms into group according to evolutionary relationship is termed as classification. Nomenclature is the process of assigning names to the various taxonomic ranking of each microbial species. The process of discovering and recording the distinguishing features of organism is called identification.

Taxonomy has fascinated humans for a long time. The two Greek philosophers Hippocrates (460-377 B.C.) and Aristotle (384-322 B.C.) made the first recorded attempt to classify all living things in the 384-322 B.C. the 4th century B.C., but their classification were not based on scientific methods. Later, after 2000 yrs in the eighteen century (1735), a Swedish biologist named Carolus Linnaeus devised a widely accepted scheme and he also laid down the basic rules for taxonomic categories or taxa and gave the binomial system of nomenclature i.e. naming of an organism by two names- genus and species. The name of the organism starts with the generic (Genus) name that is always capitalized, which is followed by the species name that begins with small letter. Both names should be written in italics or underlined if italics are not available ex . *Eschericia coli*. The source of nomenclature is usually latin or greek. Carolus Linnaeus (1707-1788) was a Swedish naturalist, called as 'Father of Taxonomy' classified the organisms according to his own system of classification (Binomial system). He wrote, 'Systema Naturae', 'Genera

Plantarum' and 'Classes Plantarum' and Philosophia Botanica. According to him existing species of plants and animals were the descendents of the previous created species. A number of species have been named in honour of a scientist who originally discovered the microbe or who had made outstanding contribution to the field. For example *E.coli*, the generic name *Escherichia* is named after Theodor Escherich, a german bacteriologist who first described the bacterium, and specific name *coli* refers to the colon which is appropriate because this organism is an enteric resident of humans.

The Linnean scheme remains the basis for biological classification today which provides each organism with a unique name and Theophrastus (370-285 B.C.) a disciple of Aristotle classified the plants on the basis of texture and is known as father of Botany. His book 'Historia Plantarum" deals with 480 plants. In the 17th century two European scientist John Ray (1627-1706) and Francis Willoughby (1635-1672) collected many plants and animals and classified them. John Ray described 18,000 plants and published a book 'Historia Generalis Plantarum" in three volumes.

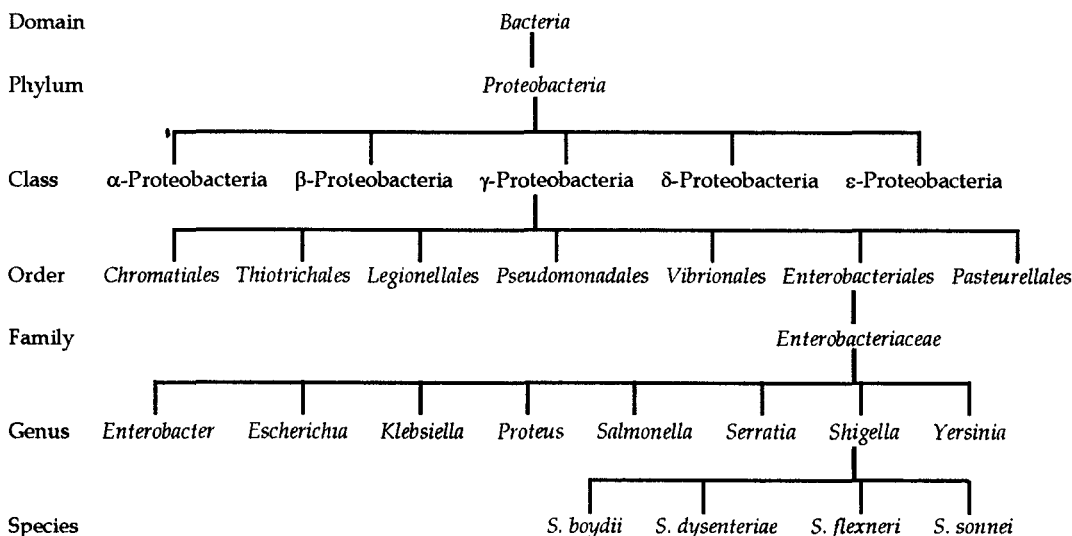

Fig. 1 : Hierarchical arrangement in taxonomy

HIERARCHICAL ARRANGEMENT IN TAXONOMY

The basic taxonomic group in microbial taxonomy is the species whereas species of higher organism are groups of interbreeding or potentially interbreeding natural populations that are reproductively isolated from other groups. A prokaryotic species is a collection of strains that share many stable properties and differ significantly from other groups of strains. According to some bacterial taxonomist. A species (genomospecies) is a collection of strains that have a similar G + C composition and 70% or greater similarity as judged by DNA hybridization experiments.

A strain is a population of organisms that is distinguishable from at least some other populations within a particular taxonomic category. Strains within a species differ slightly from one another.

Biovars : These are variant prokaryotic strains characterized by biochemical or physiological differences.

Morphovars : These are prokaryotic strain which differ morphologically.

Serovars : These are prokaryotic strain which differ serologically or with different antigenic properties.

One strain of a species is designated as the type strain. It is usually one of the first strain studied and often more fully characterized than other strains. Each species is assigned to a genus, the next rank in the taxonomic hierarchy. A genus is a well defined group of one or more species that is clearly separate from other genera or a genus. Category containing a single series or a monophyletic group of species, which is separated from other genera by a decided gap. The next rank in the taxonomic classification is family which is a taxonomic category containing one or more related genera and separated from other related families by important and characteristic differences. Next group of taxonomic classification is order which may include super orders or suborders. Class is the subdivision of a phyla. A class is the basic category of the class group which may include super class or infra class. The next category of taxonomic classification is phylum which is divided into super phylum or sub phylum. The kingdom is the highest taxonomic category. All animals are included in animal kingdom and all plants are included in the plant kingdom.

Thus in brief the main taxa or groups in a classification scheme are organized in several ascending ranks beginning with :

Species : It is a group of related isolates or strains.

Genus : It is a collection of related species.

Family : A collection of similar genera. In prokaryotic nomenclature, the name of the family ends in the suffix-aceae.

Order : A collection of similar families. In prokaryotic nomenclature the name of the family ends in the suffix-ales.

Class : It is a collection of similar orders. In prokaryotic nomenclature the name of the family ends in the suffix-ia.

Phylum or Division : A collection of similar classes.

Kingdom : A collection of similar phyla or division. The number of different kingdom varies according to the classification system used.

Domain : A collection of similar kingdom. The domain is a relatively new taxonomic category that reflects the characteristic of the cells that make up the organism.

All individual members of a species must be very much alike. The highest taxon such as kingdoms, contain organisms that are quite different from one another.

The classification of microorganisms began in 1674 with the invention of light microscope and today is a discipline based on increasingly complex criteria. The earliest schemes assigned microorganisms to one or the other of the two major categories of

living things plants and animals i.e two kingdom plantae and Animalia. In the nineteenth century scientists began to realize that the assignments of certain members viz. Protozoa, Algae, Fungi and Bacteria into these two kingdom is very artificial for example: microorganism are neither plants nor animals. Nearly every group has representatives with plant like properties and others with animal like properties. Thus the german biologist Ernst Haeckel in 1866 proposed a three kingdom concept—Plants, Animals and microorganism (the Protista). He proposed that the bacteria, algae, fungi and protozoa that lacked tissue differentiation be removed from the plant and animal kingdoms and be separated into third kingdom called Protista. This scheme served biology well for nearly 60 years. By the 1930's there was reason to revise Haeckel's classification scheme. By using the newly available electron microscope, scientists discovered that there were two types of cells-prokaryotic or eukaryotic.

By the 1930s to 1959 several system of classification was proposed but the one that is most widely accepted was given by Robert H. Whittaker (1959), an American taxonomist of Cornell university. This system places all living things (except the viruses) into five kingdoms based on cellular organisation and nutritional patterns (i) the procaryotae or monera (ii) The protista (iii) The myceteae or fungi (iv) The plantae (v) The animalia (Table 1)

TABLE 1
Whittaker Five Kingdom Concept

Property	Plantae	Animalia	Protista	Fungi	Monera
Cell type	Eukaryotic	Eukaryotic	Eukaryotic	Eukaryotic	Prokaryotic
Cell organization	Mostly multicellular	Mostly multicellular	Mostly unicellular	Multicellular and unicellular	Mostly unicellular
Cell wall	Present	Absent	Present in some, absent in others	Present	Present in most
Nutritional class	Phototrophic	Heterotrophic	Heterotrophic and Phototrophic	Heterotrophic	Phototrophic, heterotrophic or Chemoautotrophic
Mode of nutrition	Mostly absorptive	Mostly ingestive	Absorptive or ingestive	Absorptive	Absorptive
Motility	Mostly nonmotile	Mostly motile	Motile or nonmotile	Non motile	Motile or non motile
Example	Algae, mosses, ferns, all other plants	Invertebrates, vertebrates	Protozoans, slime molds, some algae	Molds, yeasts, mushrooms, rusts and smuts	Eubacteria, Archaeobacteria

According to Whittaker classification protista originate from monera. From this protista all three kingdom developed.

1. Monera

- (a) Cell is prokaryotic.
- (b) DNA lack histone protein.
- (c) They lack sexual reproduction.
- (d) Cell wall lack cellulose but contain polysaccharide/polypeptide called murein.
- (e) Flagella lack 9 + 2 arrangement.
- (f) Bacteria have anaerobic photosynthesis.

Ex : Bacteria, blue-green algae.

2. Protista

- (a) Cell is unicellular and eukaryotic.
- (b) DNA with histone protein.
- (c) Flagella with 9 + 2 arrangement.
- (d) Autotrophic mode of nutrition.
- (e) Absorb or intake food by absorption or ingestion.

Ex : Protozoa and unicellular algae.

3. Plantae

- (a) Organism are multicellular eukaryotic.
- (b) Organism lack movement.
- (c) Body bear hold fast or other part for anchorage.
- (d) Cell wall of cellulose.

Ex: Algae (Rhodophyta, Phaeophyta, Chlorophyta), Bryophyta, Fern, Gymnosperm and Angiosperm.

4. Myceteae

- (a) Cell with cell wall.
- (b) Lack chloroplast /chlorophyll.
- (c) They have heterotrophic mode of nutrition.
- (d) Vegetative thallus is mycelium.

5. Animalia:

- (a) Multicellular.
- (b) Cell is eukaryotic.
- (c) Cell lack cell wall.
- (d) Heterotrophic mode of nutrition, lack photosynthesis.

ex. Animals

The five kingdom system is not accepted by many biologist. A major problem is its lack of distinction between archae and bacteria. The kingdom protista, Plantae and fungi are ill defined. For example the brown algae are probably not closely related to

plants even though the five kingdom system places them in the plantae. Because of these problems with five kingdom system, various alternative is the six kingdom system was the simplest option where the kingdom monera or prokaryote divided into two kingdom viz. Eubacteria and Archaeobacteria.

Cavalier Smith (1987, 1993) believes that differences in cellular structure and genetic organization are exceptionally important in determining phylogeny. He used rRNA sequences and other molecular data in developing his classification. He divided all organism into two empires (Bacteria and Eukaryota). The empire bacteria contains two kingdom the eubacteria and Archaeobacteria. The second empire the eukaryota contain six kingdom of eukaryotic organism viz. Archezoa, Protozoa, Plantae, Chromista, Fungi and Animalia. The group Archezoa are primitive eukaryotic unicellular organism such as *Giardia* with 70s ribosome and lack golgi apparatus, mitochondria, chloroplast and peroxisomes.

The kingdom chromista contain many photosynthetic organism that have their chloroplast within the lumen of the rough E.R. rather than in the cytoplasmic matrix. Diatom, brown algae, cryptomonads and oomycetes are all placed in the chromista.

He acquire a completely new kind of information in the late 1960's as scientists became able to determine the sequences of monomers in macromolecules. This flow of new information has continued at an ever increasing rate. Sogin and his coworker do not cluster the eukaryotic into a few major divisions but consider them to be a single domain or empire composed of a collection of independently evolved lineages. By the 1970's molecular biologists realized that prokaryotic consist of two different and unrelated groups. They are as distantly related to each other as they are to eukaryotes. To accommodate this new information three microbiologists C. Woese, O. Kandler and M.L. Wheelis introduced a new classification scheme in 1990. They proposed that all organisms be divided into three major groups or super kingdoms called domains: the eukarya (containing all eukaryotes), the bacteria (containing most familiar prokaryotes), and the Archaea (originally called archae bacteria and containing prokaryotes that live mostly in extreme environments).

The discovery of three cell types was based on the observations that ribosomes are not the same in all cells. Ribosomes provide a method of comparing cells because ribosomes are present in all cells. Comparing the sequences of nucleotides in 16S rRNA from different kinds of cells shows that there are three distinctly different cell groups: the eukaryotes and two different types of prokaryotes the bacteria and the archaea.

In 1978 Carl R. Woese proposed elevating the three cell types to a level above kingdom called domain. Woese believed that the archaea and the bacteria, although similar in appearance, should form their own separate domains on the evolutionary tree. In this scheme, animals, plants, fungi and protests are the kingdoms in the domain eukarya. Organisms are classified by cell types in the three domain systems.

The Domain Bacteria includes all of the pathogenic prokaryotes as well as many of the nonpathogenic prokaryotes found in soil and water. The photoautotrophic prokaryotes are also in this domain. The domain Archaea includes prokaryotes that do

not have peptidoglycan in their cell walls. They often live in extreme environments and carry out unusual metabolic processes. Archaea include three major groups:

- (i) The methanogens, strict anaerobes that produce methane (CH_4) from CO_2 and H_2 .
- (ii) Extreme halophiles, which require high concentration of salt for survival.
- (iii) Hyperthermophiles which normally grow in hot environment.

Originally archae were thought to be the most primitive group, whereas bacteria were assumed to be more closely related to eukaryotes. However studies of rRNA indicate that a universal ancestor split into three lineages.

In sequencing the genome of a prokaryote called *Thermotoga maritima* microbiologist Karene Nelson has discovered that this species has genes similar to members of both the domain bacteria and the domain Archaea. Her finding suggest that *Thermotoga* is one of the earliest cells arising before the bacteria and Archaea split apart. Thus *Thermotoga* is referred to as one of the "deeply branching genera" that is near the origin or root of the evolutionary tree. Major differential features among bacteria, Archaea and Eukaryo are described in the Table (2).

TABLE 2
Major Differential Features Among Bacteria, Archaea and Eukarya

Characteristic	Bacteria	Archaea	Eukarya
Morphological and Genetic			
Prokaryotic cell structure	Yes	Yes	No
DNA present in covalently closed and circular form	Yes	Yes	No
Histone protein present	No	Yes	Yes
Membrane enclosed nucleus	Absent	Absent	Present
Cell wall	Muramic acid present	Muramic acid absent	Muramic acid absent
Membrane lipids	Ester linked	Ether linked	Ester linked
Ribosomes (mass)	70S	70S	80S
Initiator (tRNA)	Formymethionine	Methionine	Methionine
Introns in most genes	No	No	Yes
Operons	Yes	Yes	No
Capping and poly A tailing of mRNA	No	No	Yes
Plasmids	Yes	Yes	Rare

Contd...

...Contd.

Characteristic	Bacteria	Archaea	Eukarya
Ribosome sensitivity to diphtheria toxin	No	Yes	Yes
RNA polymerases	One (4 subunits)	Several (8-12 subunits each)	Three (12-14 subunits each)
Transcription factors required	No	Yes	Yes
Promoter structure	-10 to - 35 sequences	TATA Box	TATA Box
Sensitivity to chloranphenicol, streptomycin and kanamycin	Yes	No	No
Physiological			
Methanogenesis	No	Yes	No
Dissimilative reduction of S ⁰ or SO ₄ ³⁻ to H ₂ S or Fe ⁺³ → Fe ⁺²	Yes	Yes	No
Nitrification	Yes	No	No
Denitrification	Yes	Yes	No
Nitrogen fixation	Yes	Yes	No
Chlorophyll based photosynthesis	Yes	No	Yes (in chloroplast)
Rhodopsin based energy metabolism	Yes	Yes	No
Chemolithotrophy	Yes	Yes	No
Gas vesicles	Yes	Yes	No
Synthesis of carbon storage granules composed of poly-β - hydroxy-alkanoates	Yes	Yes	No
Growth above 80°C	Yes	Yes	No
Examples	<i>E.coli</i>	<i>Methanosarcina</i>	<i>Amoeba</i>

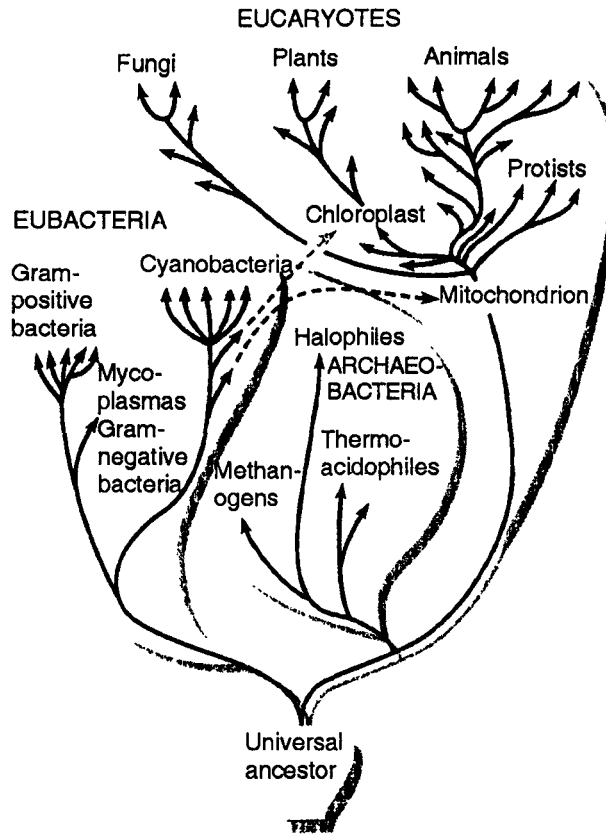

Fig. 2 : The three-domain system

MODERN TRENDS IN CLASSIFICATION

Microorganisms are regarded as a collection of evolutionary different organisms. Modern taxonomy is an exciting and dynamic field. New techniques in molecular biology and genetics are providing new insights into classification and evolution. The characters used to classify bacteria fall into two groups, i.e. traditional or classical and genomics.

Traditionally, taxonomists have used morphology, biochemistry, physiology, cultural characters, serology, ecological and phage typing to make decisions about bacterial species. Where as genome comparison include, comparison of proteins, Nucleic acid base composition, nucleic acid hybridization and nucleic acid sequencing etc. Table (3).

TRADITIONAL CHARACTERS

The following are the types of characters used in classification:

1. **Morphological characters** : In a microscope a bacteria reveals several useful

characters viz shape of individual cells, their arrangement (single or in chains, clusters packets etc) arrangement of flagella, types of motility and their response towards gram stain. All these features are important in microbial taxonomy for many reasons. Morphology is easy to study and analyze particularly in eukaryotic microorganisms and

TABLE 3
Characters Used for the Classification of Bacteria

Characters	Examples	Comments
Traditional		
Morphology	Cell shape, arrangement of cells, presence and arrangement of flagella, gram strain	Used to identify species and genera, gram strain to divide two groups of bacteria.
Biochemistry & Physiology	Conditions required for growth (pH, temp, osmotic strength, oxygen) carbon sources used, end product of fermentation (acid and gases) specific enzymes	Used to identify species, genera and higher groups.
Serology	Slide agglutination, fluorescent-labelled antibodies	Used to identify strains and species
Phage typing	Susceptibility to a group of bacteriophages	Used to identify strains
Ecological	Organism growing in fresh water, terrestrial and marine environment symbiotic relationship, life cycle patterns.	Used to identify genera and species
Genome Comparisons		
Protein Comparison	-NH ₂ acid sequences, mRNA sequences, cytochrome sequences, ET protein, histones, heat shock proteins, transcription and translation protein, metabolic enzymes.	Used to identify genera and species.
Nucleic Acid base	% G + C ratio, melting point or density of DNA.	Values similar in closely related groups
Composition N. Acid hybridization	Amount of annealing between single stranded DNA from pair of organisms	Determine relatedness between/within genera
N. Acid sequencing	Complete genome, genes encoding rRNA, genes encoding proteins	Determine relatedness of all cellular organism

Courtesy : Ingraham & Ingraham, Introduction to Microbiology.

the more complex prokaryotes. In addition these characters are valuable because structural features depend on the expression of many genes, are usually genetically stable and normally these do not vary greatly with environmental changes. Thus, morphological similarity often is a good indication of phylogenetic relatedness.

2. Biochemical and Physiological characters : Many of the biochemical and physiological characters used to classify bacteria are based on conditions that support growth. Do the bacteria grow aerobically, anaerobically or both? What incubation temperature is most favourable? Over what range of PH do they grow? Are they able to withstand high osmotic strength? What end products and enzymes do they form? Carbon sources that support growth are a particularly useful set of characters because most bacteria can use so many different carbon sources. In fact it's possible to identify many species of bacteria just by the carbon sources they use. Modern technique make this a relatively easy task. A plastic plate with 96 depressions is prepared each containing a colourless form of a tetrazolium dye (an oxidation /reduction indicator that is colorless when oxidized and colored when reduced) and a different carbon source. Then a suspension of bacterial cells is added. If the organism can use the carbon source, the dye is reduced and becomes colored. The color pattern is read by a machine and results are fed directly into a computer. In a few minutes the computer displays the name of the bacterium.

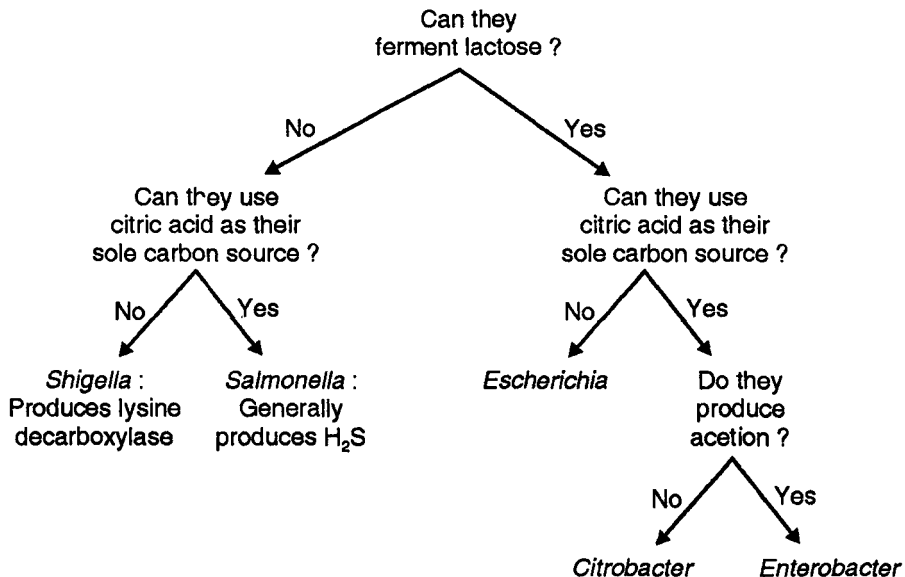

Fig. 3 : Use of metabolic characteristics to identify selected genera of enteric bacteria

Fermentation properties of bacteria are also useful characters. Thus biochemical characters such as metabolic end products and the presence or absence of a particular enzyme or pathway.

3. Cultural characters : These include the cultural requirements for multiplication

(e.g. nutrients, oxygen, temperature etc) and the way growth occurs in liquid media, and particularly on solid media (e.g. colony form)

4. Serology : The other way to classify and identify bacteria is through serology (the science that studies serum, the noncellular fraction of blood). Serum contains antibodies (protein molecules made in response to infection). And these antibodies are highly specific, they target specific microbes. Thus antibodies can distinguish between closely related microorganisms and even between strains. Sera that inactivate particular bacteria are called antisera. This antisera are used in a number of ways. For example, they can be used in slide agglutination test to identify particular species or strains. Fluorescent labelled antibodies prepared from antisera are also used in a similar but more sensitive procedure.

5. Phage typing : Bacteriophages, or phages (viruses that attack bacteria) can also be used to classify bacteria. The pattern of strains attacked by a set of bacteriophages is called phage typing. The diversity of bacterial strains that one bacteriophage will attack (termed the host range) is quite narrow. Only closely related bacterial strains are attacked by the same phages, phage typing is usually restricted to classifying strains within species.

In phage typing, a thin layer of the bacterial strain to be tested is spread on the surface of an agar plate and small drops of suspensions of various phages are placed on the surface. If the bacteria are susceptible to the phages in one or more of the drops they will lyse, producing a clear zone in the lawn (confluent layer of bacterial growth) that forms.

Strains with identical phage types are identical. Strains with similar phage types are closely related. Because phage typing can identify specific strains of bacteria, it is used to determine if a cluster of bacterial infection is caused by the same strain.

6. Fatty acid analysis (FAME) : Bacteria differ in the type and relative quantity of fatty acids that make up their membranes, thus the cellular fatty acids composition can be used as an identifying marker. In gram -ve bacteria the fatty acids are present in both, the cytoplasmic and the outer membranes. Whereas in gram +ve bacteria (lacking an outer membrane), the cytoplasmic membrane is the source of fatty acids. To analyse their fatty acid composition, bacterial cells are grown under standardised conditions. After this the cells are chemically treated with sodium hydroxide and methanol to release the fatty acids and to convert those acids to their more volatile methyl ester form (FAME = Fatty acid methyl ester).

The resulting fatty acids, methylated esters can then be separated and analysed using gas chromatography. By comparing the pattern of peaks, or chromatogram, to those of known species and isolate can be identified.

GENOME COMPARISON

In the 1960s taxonomists began to develop methods to examine greater portions of the genome. Some of the most powerful approaches to taxonomy are through the study of proteins and nucleic acids because these are either direct gene products or

the genes themselves. Comparisons of proteins and nucleic acids yield considerable information about true relatedness. These molecular approaches have become increasingly important in prokaryotic taxonomy.

Comparison of Protein

Amino acid sequences of proteins are direct reflections of mRNA sequences and therefore closely related to the structures of the genes coding for their synthesis. Comparisons of proteins of different microorganisms are very useful taxonomically. If the sequences of proteins with the same function are similar, the organisms possessing them are probably closely related. The sequences of cytochromes and other electron transport proteins, histones, heat shock proteins, transcription and translation proteins and a variety of metabolic enzymes have been used in taxonomic studies. The electrophoretic mobility of proteins is useful in studying relationships at the species and subspecies level.

The physical kinetic and regulatory properties of enzymes have been employed in taxonomic studies. Because enzyme behavior reflects NH₂ acid sequences, which is useful in studying some microbial group and group specific patterns of regulation have been found.

Nucleic Acid Base Composition

This technique proved useful for microbes. Their genomes can be directly compared and taxonomic similarity can be estimated in many ways. It is possibly the most simplest technique to be used in the determination of DNA base composition. However, it can be determined chemically by hydrolyzing DNA sample and separating the free bases with HPLC, it can be determined more easily by physical methods which is most frequently used. DNA contains four purine and pyrimidine bases-Adenine (A), Guanine (G), Cytosine (C) and Thymine (T). In double stranded DNA, A pairs with T and G pairs with C. Thus (G + C) / (A + T) ratio or G + C content is the percent of G + C in DNA, reflects the base sequence and varies with sequence changes as follows:-

$$\text{Mol \% G + C} = \frac{\text{G+C}}{\text{G+C+A+T}} \times 100$$

The G + C content often is determined from the melting temperature (T_m) of DNA. In DNA structure 3 hydrogen bonds join GC base pairs and two bonds connect AT base pairs. As a result the DNA with greater G + C content will have more hydrogen bonds and its strands will separate only at higher temperatures that is it will have a higher melting point. DNA melting can be easily followed spectro photometrically because the absorbance of 260 nm UV light by DNA increases during strand separation. When a DNA sample is slowly heated, the absorbance increases as hydrogen bonds are broken and reaches a plateau when all the DNA has become single stranded. The melting point of the rising curve gives the melting temperature, a direct measure of the G + C content. Since the density of DNA also increases linearly with G + C content, the percent G + C can be obtained by centrifuging DNA in a Caesium chloride density

gradient. This method can be used because the density of DNA is also a function of (G + C): (A + T) ratio.

The G + C content of the nuclear DNA of major groups of organism has been studied. In both plants and animals the ranges are relatively narrow and quiet similar, averages around 40% and ranges between 30 -50%. However in prokaryotic microorganism the G + C content is highly variable ranging from around 25 to almost 80%. For example, various *Streptococci*, *Pneumococci* and *Lactobacilli* have a similar value (38-40%) which have been traditionally grouped together as lactic acid bacteria (because of their characteristic fermentation). The G + C content of strains within a particular species is constant. If two organisms differ in their G + C content by more than about 10%, their genomes have quite different base sequences.

Taxonomically these G + C data are valuable for at least two reasons:

- ✧ They can confirm a taxonomic scheme developed using other data. If organisms in the same taxon are too dissimilar, in G + C content the taxon probably should be divided.
- ✧ The G + C content appears to be useful in characterizing prokaryotic genera since the variation within a genus is usually less than 10% even though the content may vary greatly between genera. For example *Staphylococcus* has a G + C content of 30 - 38% whereas *Micrococcus* DNA has 64 to 75% G + C, yet these two genera of gram positive cocci have many other features in common.

Nucleic Acid Hybridization

The similarity between genomes can be compared more directly by use of nucleic acid hybridization studies. This includes DNA-DNA homology or DNA base sequence and RNA sequences. If a mixture of single stranded DNA (formed by heating of ds DNA) is cooled and held at a temperature about 25°C below the T_m , strands with complementary base sequences will reassociate to form stable dsDNA, and the non complementary strands will remain single. Incubation at 10-15°C below the T_m permits hybrid formation day with almost identical strands.

The most widely used hybridization techniques include nitro-cellulose filters which bounds nonradioactive DNA strands are incubated at the appropriate temperature with single stranded DNA fragments made radioactive with ^{32}P , 3H or ^{14}C . After radioactive fragments are allowed to hybridize with the membrane bounds single stranded DNA, the membrane is washed to remove any non hybridized single stranded DNA and its radioactivity is measured. The quantity of radioactivity bound to the filter reflects the amount of hybridization and thus the similarity of the DNA sequences. The degree of homology is expressed as the percent of experimental DNA radioactivity retained on the filter compared with the percent of homologue DNA radioactivity bound under the same conditions. Two strains whose DNA's show at least 70% relatedness under optimal hybridization conditions and less than a 5% difference in T_m is often considered as members of the same species. However DNA preparation from two unrelated bacteria, could not hybridise or they will not form a stable detectable hybrid. Therefore DNA-

DNA hybridization is used to study only closely related microorganism and the more distantly related organisms are compared by carrying out DNA- RNA hybridization experiments or by forming duplex between single stranded DNA and complementary RNA strands. It includes the experiments carrying out using radioactive ribosomal or tRNA. Distant relationships can be detected because rRNA and tRNA genes represent only a small portion of the total DNA genome and have not evolved as rapidly as most other microbial genes. The RNA molecules are highly conserved in an evolutionary sense and provide a very useful measure of the phylogenetic relationships of the wider groupings of microorganisms. The chosen molecules are 16 SrRNA and 5SrRNA. Although this technique of nucleic acid hybridization have not yet provided a phylogenetic bacterial taxonomy to replace the classical Bergey's determinative key.

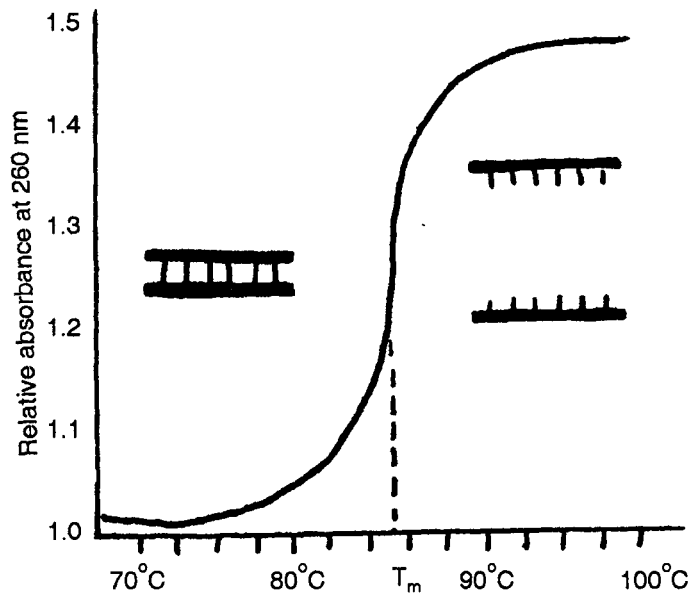

Fig. 4 : A DNA melting curve

NUCLEIC ACID SEQUENCING

The sequence of bases in DNA determines an organism's genetic plan. Thus on identical sequence means identical organisms and a similar sequence means closely related organisms, comparing DNA base sequences is the ultimate tool of taxonomy. The substantial length of DNA sequence can be measured by Maxam and Gilbert method or measured sequenced by Sangers. By the advancement of technology it is now possible by sequencing both DNA and RNA. By far RNA sequencing has been used more extensively in microbial taxonomy and the most attention is given to sequences of 5S and 16SrRNA's isolated from 50 S and 30 S subunits respectively of prokaryotic ribosomes. The rRNA are almost ideal for studies of microbial evolution and relatedness since it

is essential to a critical organelle found in all microorganisms. Their functional role is same in all ribosomes. Furthermore their structure changes very slowly with time. Because the structure of ribosome cannot tolerate much change and still remain functional, rRNA is highly conserved. Thus the rRNA of even distantly related organisms is similar enough that we can not count their number of differences and thus calculate the evolutionary distance between them. The sequencing of SSrRNA from different organisms to determine relatedness between organisms is based on the assumption that the molecule in all organisms have a common origin: they were originally identical as one species evolves into another the DNA sequences encoding rRNA change but the rRNA continues to serve the same function. The similarity of DNA sequences encoding a molecule such as 5S rRNA is therefore a direct measure of the relatedness of the organisms that produced those molecule. Conversely the number of differences in their DNA sequences is a measure of evolutionary distance between a pair of organisms.

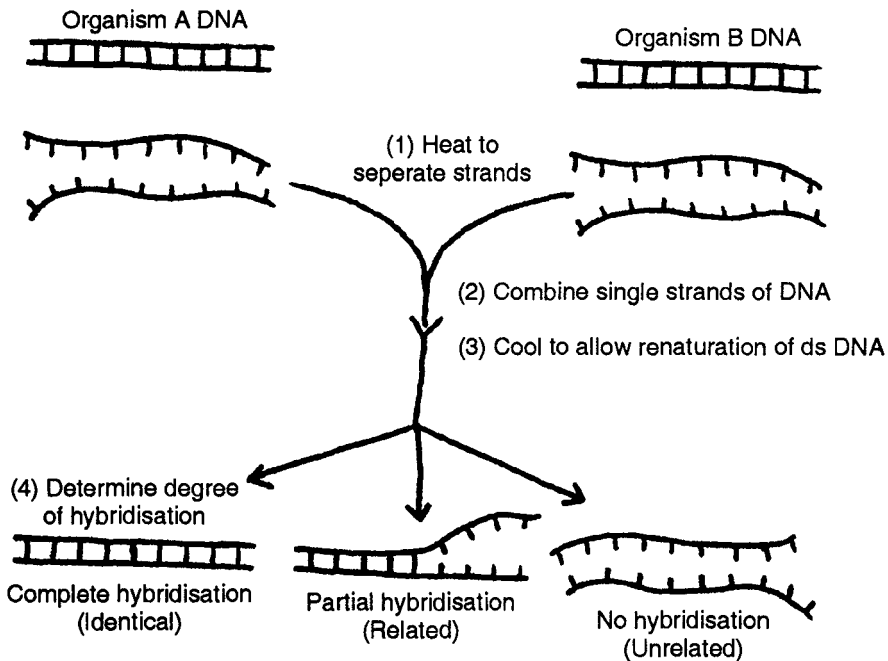

Fig. 5 : Nucleic acid melting and hybridization

Because rRNA contains variable and stable sequences both closely related and very distantly related microorganism can be compared. The studies on the sequences of bases in rRNA first revealed that the archaea are a separate major biological group.

A complete rRNA can be sequenced using several different procedures. In one approach, RNA is first isolated, purified. Then reverse transcriptase is used to make complementary DNA (cDNA) using primers that are complementary to conserved rRNA sequences. Next the PCR amplifies the cDNA. Finally the cDNA is sequenced and the rRNA sequence deduced from the results. Now a days is used to amplify the 16 S rRNA

from the bacterial genome. The amplified rRNA then sequenced either manually or by an automated sequence using the Sanger method.

The relatedness of organisms can be determined by comparing the sequences of bases in genes that encode proteins. It is possible because every organism has a few proteins that serve the same function in all organisms. Sequencing the genes that encode these proteins gives information much like that gained from sequencing SSrRNA.

RNA FINGER PRINTING AND SEQUENCING

A number of tRNA and 5SrRNA have been sequenced but because they are small molecules the amount of information they contain is fairly low. More useful for taxonomic purposes are sequences of larger molecules such as 16S or 18S rRNA. Carl Woese was the first who initiated studies on the phylogeny of 16SrRNA. He digested 16SrRNA with a specific endonuclease producing a variety of short oligonucleotide which were separated and sequenced. It was the finding that the 16SrRNA sequences of methanogens halophiles and thermoacidophiles were unexpectedly divergent from those of other bacteria that allowed the recognition of archaebacteria as a distinctive assemblage of bacteria.

The methods devised by Woese is as follows: radioactive 16S rRNA (obtained by growing organisms in the presence of phosphate containing the radioactive isotope ^{32}P) is purified and digested with the endonuclease T_1 . This endonuclease cleaves the RNA on the 3' side of every guanosine residue hence a mixture of oligonucleotides is obtained that range in size from a single nucleotide to a dozen or more, all containing a single guanosine residue at the 3' terminus. These are now separated by two dimensional electrophoresis (the mixture is electrophoresed in one dimension in one buffer system, then in a second dimension in another buffer system) and their position determined by autoradiography. The labelled oligonucleotides can then be removed and sequenced. Practically only those with a chain length of five residues or more contain sufficient taxonomic information to be worth cataloguing. Oligonucleotide catalogues of a number of organism are analysed with the help computer program, which compares them in a pairwise fashion and result can be displayed as a dendrogram.

A detailed analysis of 16SrRNA oligonucleotide catalogues or complete sequences reveals that there are both, quiet variable and highly conserved regions of the molecule, reflecting different degrees of functional constraint on different parts of the molecule. Separate comparison of the variable and conserved regions allows determination of both close and distant relationship. In conserved regions there are sequences of that are characteristic of major groups of bacteria, termed signature sequences. At great phylogenetic distances these signature sequences are important in allowing the determination of relationships.

The rapid technique to sequence long molecules of RNA has been devised and now used in preference to finger printing. To sequence a long molecule of rRNA, bulk RNA is isolated from a culture (no need to purify) and a short RNA primer is added that is homologous to one of the conserved regions of rRNA. Dideoxy sequencing can

then be performed directly on the RNA template using the enzyme reverse transcriptase a viral enzyme that produces a DNA complement to a RNA molecule.

In prokaryotic ribosomes there are three different ribosomal RNAs i.e. 5S, 16S and 23S but only 16S sequence is used because nucleotides are neither less nor more in length and easy to sequence 1,500 nucleotides are present in 16SrRNA, the 5SrRNA contain only ~ 120 nucleotides that are too small to conclude any fruitful relationship, whereas 23S contains approximately ~ 2,900 nucleotides which are quite high in number.

DNA SEQUENCING

Either of the two different procedures can be used to sequence substantial lengths of DNA i.e. The Sanger method or the Maxam and Gilbert method. Although they differ in chemical detail, both rest on the same basic principle; a series of DNA fragments are generated which have a common starting point, but variable termini ("nested" fragments); by determining their exact length and the terminal base, the sequence can be inferred with great accuracy. Sanger method can be explained with an example.

In order to determine the sequence of bases in a segment of DNA, a large number of identical copies of it must be obtained. If the molecule that contains the sequence is relatively small (e.g. a viral genome or a plasmid), one can feasibly sequence the entire molecule. In such a case one need only separate the molecule from contaminating nucleic acid (e.g. fragments of the bacterial chromosome). If the sequence is part of a much larger molecule, such as the bacterial chromosome, the usual approach is to clone the desired segment, and sequence a restriction fragment purified from the cloned DNA. Since the Sanger method uses single-stranded DNA, the segment must either be digested with a nuclease to convert it to single-stranded DNA or, preferably, cloned in a single-stranded vector to begin with (bacteriophage M13).

Sequencing of a purified single-stranded fragment is accomplished by generating a series of complementary nested fragments of DNA by incubating the fragment with DNA polymerase, a short primer sequence complementary to a region of the fragment (often a short restriction fragment itself), the four deoxy nucleoside triphosphates (one or more of which are radioactive), and a small amount of one dideoxy nucleoside triphosphate (e.g. dideoxythymidine triphosphate). Chance incorporation of dideoxythymidine, which lacks a 3'-hydroxyl group, terminates polymerization at that point. Thus, after a suitable incubation period, the mixture will contain radioactive DNA strands of variable length, all of which terminate in a thymidine residue. The number of classes of DNA molecules, differing from each other in length, depends on the number of thymidine residues, since for every thymidine residue in the new strand, there will be a family of radioactive DNA molecules that terminates at that point.

In practice four parallel incubations are performed, identical except that each contains a different dideoxy nucleoside triphosphate, and hence will terminate at a different base. The mixture is then denatured and electrophoresed to separate the newly synthesized strands by size. The position of the radioactive bands on the gel are visualized by appressing the gel tightly to a sheet of X-ray film, which is exposed by the localized decay of the radioisotope incorporated into the DNA. Upon development,

the film displays a series of exposed bands, each of which corresponds to a size class of single-stranded DNA. The sequence can then be inferred directly from this autoradiogram; the shortest fragment will be found in the incubation mixture that contains the dideoxy analogue of the first base after the primer; the next shortest fragment will be found in the mixture that contains the dideoxy analogue of the second base after the primer, and so on for up to hundreds of bases.

DNA sequencing techniques were devised by molecular biologists and have been applied primarily to genetic problems with dramatic success, but to date the application of these techniques to taxonomic problems has been minimal. However, as the techniques are more widely applied, and a rapidly expanding library of sequences begins to include a number of homologous sequences from different organisms, taxonomists will undoubtedly come to depend increasingly on comparison of DNA base sequence to determine organismic relationships. Indeed it is probably not unrealistic to anticipate that in the near future the complete base sequence for the genomes of a number of microorganisms will be available, and microbial taxonomy may become an exact, quantitative science.

Microbial Phylogeny

Analysis of oligonucleotide catalogues of 16S rRNA has allowed the recognition that the bacteria can be divided into several major groups based on the similarity of their ribosomal RNA. The degree of sequence similarity of this molecule is a reflection of the phylogenetic distance among organism. The rate of change of the sequence of genes encoding it is much less than that of the bulk of the genome, and it is possible to determine relationship over vast evolutionary distances. The comparison of complete sequences of eubacterial and archaeobacterial 16S and eukaryotic 18SrRNA shows that even at the greatest phylogenetic distances among cellular organisms about 50% homology remains. This rRNA functions as a molecular clock, and allows accurate determination of phylogenetic distance. Following are some ways in which phylogenetic relationship are assessed.

Molecular Chronometers

The sequence of nucleic acids and proteins change with time and are considered to be molecular chronometers. This term was first suggested by Zuckerkandl and Pauling (1965), is important in the use of molecular sequences in determining phylogenetic relationship. It is assumed that there is an evolutionary clock where the sequences of many rRNA and protein gradually change over time without destroying or severely altering their functions. In molecular chronometers it is assumed that such changes occur fairly randomly, selectively neutral and increase linearly with time. When the sequence of similar molecules are quite different in two groups of organisms, the group diverged from one another a long time ago. Using molecular chronometer for phylogenetic analysis is complex because the rate of sequence change can vary because some period are recognized by especially rapid change. Along with this different molecules and various parts of the same molecule can change at different rates. Highly conserved molecules like rRNA are used to follow large scale evolutionary changes while rapidly changing molecules are employed for speciation. Many scientist believes that these molecular

chronometers especially protein clocks are not accurate and further studies are required to establish their accuracy and usefulness.

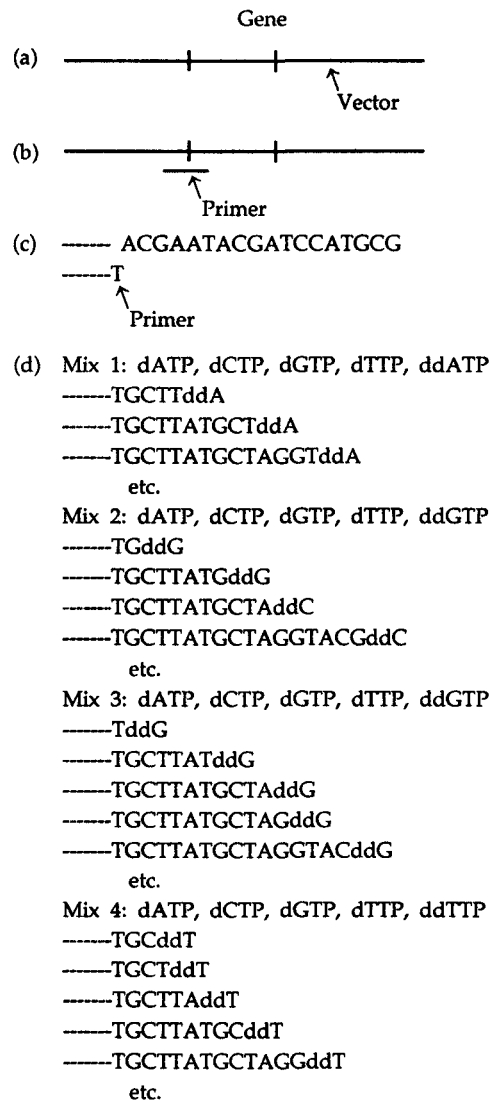

Fig. 6 : DNA sequencing by the Sanger method

(a) the single-stranded vector containing the cloned fragment to be sequenced (b) a purified restriction fragment complementary to the 5' end of the gene is added as primer (c) the sequence near the 5' end of the gene, showing the 5' end of the primer (d) the primed template is added to four different polymerization mixtures, each containing DNA polymerase, the four deoxynucleoside triphosphates, and each a different dideoxynucleoside triphosphate. The families of new complementary strands synthesized in each mixture are shown.

PHYLOGENETIC TREES

A phylogenetic tree is a graph made of branches that connect nodes. Each node represent taxonomic units like species or genes. The external node those at the end of the branches represent living organism. The length of branches may represent the number of molecular changes that takes place between the two nodes. Finally a tree can be rooted or unrooted. The rooted tree gives a node that serves as the common ancestor and shows development of the species from the root. It is a difficult task to develop a rooted tree. In contrast an unrooted tree simply represent a phylogenetic relationships but does not provide an evolutionary path.

The Phylogenetic trees are developed by comparing molecular sequences. The first step to compare two molecules is to align there sequences so that similar parts match up. The object is to align and compare homologous sequences (once that are similar because they had a common origin in the part). The computer plus complex mathematics is employed to minimize the number of gaps and mismatches in the sequence is compared.

Once the molecule is aligned the number of position that vary in the sequence can be determined and this data is used to calculate a measure of the differences between the sequences. The difference is expressed as the evolutionary distance. The evolutionary distance is a quantitative indication of the number of positions that differ between two aligned macromolecules. Statistical calculation is then made for back mutation and multiple substitution. In the next step the organism are then clustered together on the basis of similarity in the sequences. The most similar organism are then clustered together and compared with the remaining organism to form large cluster associated together at a lower level of similarity or evolutionary distance. This process is continued till all organism are included in the tree. The another technique to estimate phylogenetic tree is by parsimony analysis. Here the relationship are determined by estimating the minimum number of sequence changes required to give the final sequences being compared. It is assumed that evolutionary changes occur along the shortest pathway with the fewest changes or steps from an ancestor to the organism in question.

rRNA, DNA AND PROTEIN AS INDICATORS OF PHYLOGENY

The comparison of 16SRNA isolated from various strains of prokaryote is of great importance in determining the phylogenetic relatedness then any other molecular technique. The association coefficient or Sab Value from rRNA studies is assumed to be a true measure of relatedness, the higher the Sab value obtained from comparing two organism, the more closely the organism are related to each other. If the sequence of 16S rRNA of two organism are identical (Sab Value = 01). A group of prokaryote that branches off from other prokaryote long ago show a large range of Sab value because it has had more time to diversify than a group that developed more recently. Therefore the narrower the range of Sab value of a group of prokaryote the more modern it is. After the determination of Sab value the computer calculates the relatedness of the organism and summarize its relationship in a tree or dendrogram.

The 16SrRNA of most major phylogenetic groups has one or more character sites

nucleotide sequence called oligonucleotide signature or oligonucleotide signature sequences. These sequences are specific sequences which occur in most of all members of a particular phylogenetic groups. They are rarely or never present in other groups even of the closely related ones. Thus these sequences can be used to place the microorganism in the proper group. These sequences has been identified for various organism viz. bacteria, archaea, eukaryotes and many other prokaryotic groups.

Although rRNA comparison are useful for the species level but DNA similarity studies are more effective in categorizing individual species and genera. These comparison can be carried out by using G + C content or hybridization studies. Like rRNA the DNA composition of a cell does not change with growth conditions. The DNA comparison are based on complete genome rather than a fraction and precisely define a species based on 70% relatedness criteria.

Currently many protein sequences are used to develop phylogenetic trees. This approach has some advantages over rRNA comparisons. The sequence of 20 amino acids has more information persite than a sequences of four nucleotides. The protein sequences are less affected by organism specific differences in G + C content than DNA and RNA sequences and finally the protein sequence alignment is easier because it is not dependent on secondary structure as in an rRNA sequence. This approach involve some disadvantages like; indispensable protein with constant function do not change as rapidly whereas some protein like Ig evolve quiet rapidly. Thus all proteins are not suitable for studying large scale change that occur over long periods.

Summary it is clear that sequences of all three macromolecules viz, rRNA, DNA and proteins can provide valuable phylogenetic information but more molecular data plus further study of phenotypic properties will help to resolve uncertainties.

Numerical Taxonomy : The earliest system of biological classification were based on arbitrarily chosen criteria and this classification was termed as artificial classification. The first such system of classification which was widely accepted was that given by Linnaeus. Later when the fact of biological evolution was recognized another dimension was immediately added to the concept of natural or phentic classification. In the 19th century the classification was based on the terms of evolutionary affinities and the taxonomic hierarchy in a certain sense become the reflection of a family tree and such a taxonomic system is called as phylogenetic system.

An alternative approach for the classification is empirical one where the taxonomic arrangement is based on quantification of the similarities and differences among organism. This was first suggested by a French biologist Michal Adansona and the classification is also named as Adansonian (or numerical) taxonomy. Here each phenotypic character is given equal weighting, it should express numerically the taxonomic distances between organisms in terms of the number of characters they share, relative to the total number of characters examined.

The process begins with a determination of the presence or absence of selected characters in the group of organisms under study. Many characters at least 50 and preferably several hundred should be compared for an accurate and reliable classification. It includes many different kinds of data viz. morphological, biochemical and physiological.

After character analysis, an association coefficient a function that measures the agreement between characters possessed by two organism is calculated for each pair of organisms in the group. The simple matching coefficient (S_{sm}) is the proportion of the characters that match regardless of the whether the attribute is present or absent.

Sometimes the Jaccard coefficient (S_j) is calculated by ignoring any characters that both organism lack. Both coefficients increase linearly in value from 0.0 (no matches) to 1.0 (100% matches).

Simple matching coefficient or other association coefficients are then arranged to form a similarity matrix. This is a matrix in which the rows and columns represent organisms and each value is an association coefficient measuring the similarity of two different organisms so that each organism is compared to every other one in the table. Organisms with great similarity are grouped together and separated from dissimilar organisms. Such groups of organisms are called phenons (or phenoms).

The results of numerical taxonomic analysis are often summarized with a tree like diagram called dendrogram. The x-axis or abscissa generated in units of similarity. Each branch point is at the similarity value relating the two branches. The organisms in the two branches share so many characteristics that the two groups are seen to be separate only after examinations of association coefficient greater than the magnitude of the branch point value. Below the branch point the two groups appear to be one. A 70-phenon is a phenon with 70% or greater similarity among its constituents. Phenons formed at about 80% similarity often are equivalent to species. Numerical taxonomic methods also can be used to compare sequences of macromolecules such as RNA and proteins.

TABLE 4
Taxonomic Criteria Used for Classification
and Identification of Bacteria

Criterion	Used for	
	Classification	Identification
Morphological characteristics	No (yes for cyanobacteria)	Yes
Differential staining	Yes (for cell wall type)	Yes
Biochemical testing	No	Yes
Serology	Yes	Yes
Phage typing	No	Yes
Amino acid sequencing	Yes	No
Protein analysis	Yes	No
Base composition of nucleic acids	Yes	No
Nucleic acid hybridization	Yes	Yes (DNA probes)
Flow cytometry	No	Yes
Numerical taxonomy	Yes	No

Polyphasic Taxonomy

As we come to know by previous paragraph that all phylogenetic results vary with data used in analysis, many taxonomist believe that all possible valid data should be employed in determining phylogeny, in the approach called polyphasic taxonomy, taxonomic schemes are developed using a wide range of phenotypic and genotypic information ranging from molecular properties to ecological characteristics. The criteria for the selection of techniques depend upon the level of taxonomic resolution needed. Like serological technique is used to identify strains, but not for genera or species. Protein electrophoretic pattern is useful in determining species but not for genera or families. DNA hybridization and percentage G + C content can be used to study species and genera other characteristic like chemical composition, DNA probe result, rRNA sequences, DNA sequences can be used to define species, genera and families.

□□□

5

NOMENCLATURE AND BERGEY'S MANUAL

Bacterial systematics has undergone several changes and is continuously in a state of flux as our knowledge of microorganism is far from complete and new information is being added every day. In 1923 David Bergey, professor of bacteriology at the University of Pennsylvania and four colleagues published a classification of bacteria that could be used for identification of bacterial species. The Bergey's manual of determinative bacteriology has been a widely used reference since publication of the first edition in 1923. This manual is now in its ninth edition edited in 1992. The manual does not classify bacteria according to evolutionary relatedness but provides identification (determining) schemes based on such criteria as cell wall composition, morphology, differential staining, oxygen requirement and biochemical testing. In this volume bacteria are assigned 19 parts based primarily on following features like energy and carbon source, mode of locomotion, morphology and gram stain reaction, gaseous requirement and endospore formation ability. The edition was published by Wilkins and Baltimore company of USA.

From 1984, the Bergey's Manual was renamed Bergey's Manual of systematic Bacteriology is being published in separate volumes. This manual includes 35 sections based on characters like general shape, morphology, gram staining, presence of endospore, motility, oxygen relationships, mode of energy production. The manual include four divisions of the kingdom Prokaryotae. The Gracilicutes (gram -ve cellwall) Firmicutes (gram + ve cell wall other than actinomycetes), Tenericutes (bacteria lacking cell wall other than actinomycetes) and Mendoricutes (bacteria lacking peptidoglycan in their cell wall like Archaeobacteria).

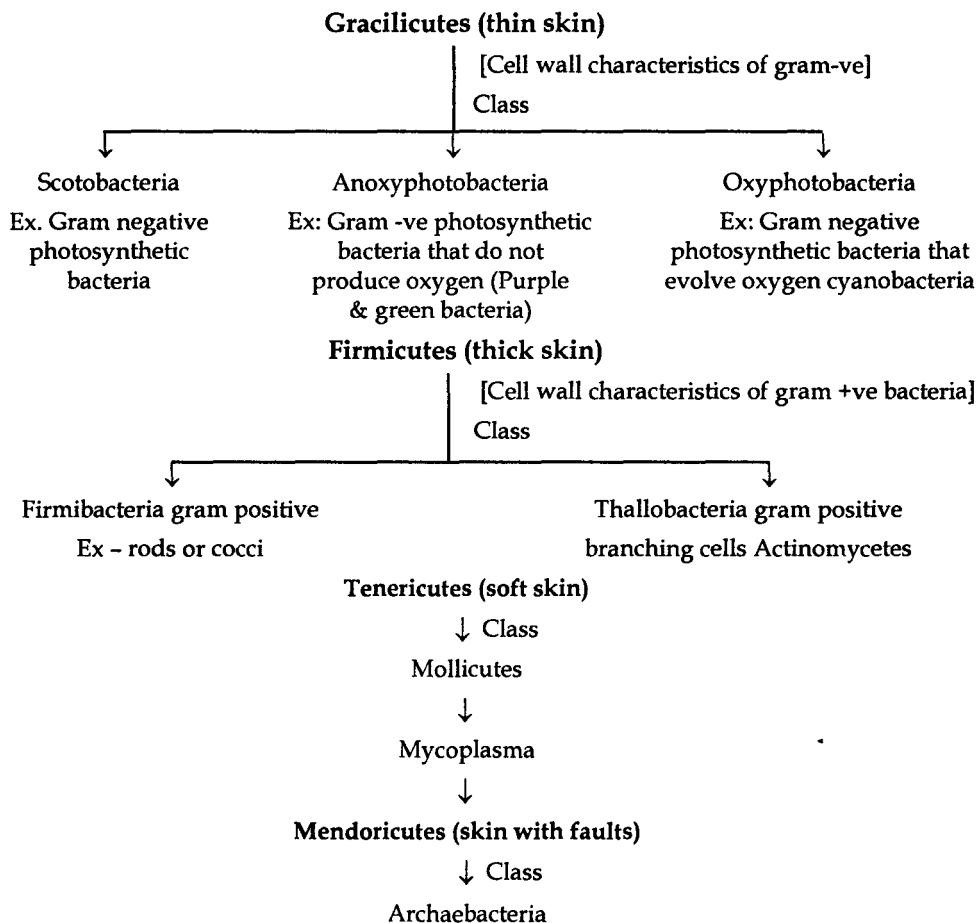

After 1984, the year of publication of first volume of Bergey's manual of systematic bacteriology much work has done on sequencing of rRNA, DNA and proteins which has made the phylogenetic analysis of prokaryote feasible. As a consequence, the second edition of Bergey's manual is largely phylogenetic rather than phonetic and thus quiet different from the first edition and second edition is published in five volumes. It has more ecological information about individual taxa. The second edition does not group all the clinically important prokaryotes together as the first edition, instead, pathogenic sps will be placed phylogenetically and thus scattered throughout the following five volumes.

- Vol. 1 – The Archaea, and the deeply branching and phototrophic bacteria.
- Vol. 2 – The Proteobacteria
- Vol. 3 – The low G + C gram + ve bacteria
- Vol. 4 – The high G + C gram + ve bacteria
- Vol. 5 – The Planctomycetes, Spirochaetes, Fibrobacteres, Bacteroidetes and Fusobacteria.

TABLE 1
Organization of Bergey's Manual of Systematic Bacteriology

Taxonomic Rank	Representative Genera
Volume 1. <i>The Archaea and the deeply Branching and Phototrophic Bacteria</i>	
Domain <i>Archaea</i>	
Phylum <i>Crenarchaeota</i>	<i>Thermoproteus, Pyrodictium, Sulfolobus</i>
Phylum <i>Euryarchaeota</i>	
Class I. <i>Methanobacteria</i>	<i>Methanobacterium</i>
Class II. <i>Methanococci</i>	<i>Methanococcus</i>
Class III. <i>Halobacteria</i>	<i>Halobacterium, Halococcus</i>
Class IV. <i>Thermoplasmata</i>	<i>Thermoplasma, Picrophilus, Ferroplasma</i>
Class V. <i>Thermococci</i>	<i>Thermococcus, Pyrococcus</i>
Class VI. <i>Archaeoglobi</i>	<i>Archaeoglobus</i>
Class VII. <i>Methanopyri</i>	<i>Methanopyrus</i>
Domain <i>Bacteria</i>	
Phylum <i>Aquificae</i>	<i>Aquifex, Hydrogenobacter</i>
Phylum <i>Thermotogae</i>	<i>Thermotoga, Geotoga</i>
Phylum <i>Thermodesulfobacteria</i>	<i>Thermodesulfobacterium</i>
Phylum <i>Deinococcus-Thermus</i>	<i>Deinococcus, Thermus</i>
Phylum <i>Chrysiogenetes</i>	<i>Chryogenes</i>
Phylum <i>Chloroflexi</i>	<i>Chloroflexus, Herpetosiphon</i>
Phylum <i>Thermomicrobia</i>	<i>Thermomicrobium</i>
Phylum <i>Nitrospira</i>	<i>Nitrospira</i>
Phylum <i>Deferribacteres</i>	<i>Geovibrio</i>
Phylum <i>Cyanobacteria</i>	<i>Prochloron, Synechococcus, Pleurocapsa, Oscillatoria, Anabaena, Nostoc, Stigonema</i>
Phylum <i>Chlorobi</i>	<i>Chlorobium, Pelodictyon</i>
Volume 2. <i>The Proteobacteria</i>	
Phylum <i>Proteobacteria</i>	
Class I. <i>Alphaproteobacteria</i>	<i>Rhodospirillum, Rickettsia, Caulobacter, Rhizobium, Brucella, Nitrobacter, Methylobacterium, Beijerinckia, Hyphomicrobium</i>
Class II. <i>Betaproteobacteria</i>	<i>Neisseria, Burkholderia, Alcaligenes, Comamonas, Nitrosomonas, Methylophilus, Thiobacillus</i>
Class III. <i>Gammaproteobacteria</i>	<i>Chromatium, Leucothrix, Legionella, Pseudomonas, Azotobacter, Vibrio, Escherichia, Klebsiella, Proteus, Salmonella, Shigella, Yersinia, Haemophilus</i>

Contd...

Contd...

Taxonomic Rank	Representative Genera
Class IV. Deltaproteobacteria	<i>Desulfovibrio, Bdellovibrio, Myxococcus, Polyangium</i>
Class V. Epsilonproteobacteria	<i>Campylobacter, Helicobacter</i>
Volume 3. The Low G + C Gram - positive Bacteria	
Phylum <i>Firmicutes</i>	
Class I. Clostridia	<i>Clostridium, Peptostreptococcus, Eubacterium, Desulfotomaculum, Heliobacterium, Veillonella</i>
Class II. Mollicutes	<i>Mycoplasma, Ureaplasma, Spiroplasma, Acholeplasma</i>
Class III. Bacilli	<i>Bacillus, Caryophanon, Paenibacillus, Thermoactinomyces, Lactobacillus, Streptococcus, Enterococcus, Listeria, Leuconostoc, Staphylococcus</i>
Volume 4. The High G + C Gram- positive Bacteria	
Phylum Actinobacteria	
Class Actinobacteria	<i>Actinomyces, Micrococcus, Arthrobacter, Corynebacterium, Mycobacterium, Nocardia, Actinoplanes, Propionibacterium, Streptomyces, Thermomonospora, Frankia, Actinomadura, Bifidobacterium</i>
Volume 5. The Planctomycetes, Spirochaetes, Fibrobacteres, Bacteroidetes, and Fusobacteria	
Phylum <i>Planctomycetes</i>	<i>Planctomyces, Gemmata</i>
Phylum <i>Chlamydiae</i>	<i>Chlamydia</i>
Phylum <i>Spirochaetes</i>	<i>Spirochaeta, Borrelia, Treponema, Leptospira</i>
Phylum <i>Fibrobacteres</i>	<i>Fibrobacter</i>
Phylum <i>Acidobacteria</i>	<i>Acidobacterium</i>
Phylum <i>Bacteroidetes</i>	<i>Bacteroides, Porphyromonas, Prevotella, Flavobacterium, Sphingobacterium, Flexibacter, Cytophaga</i>
Phylum <i>Fusobacteria</i>	<i>Fusobacterium, Streptobacillus</i>
Phylum <i>Verrucomicrobia</i>	<i>Verrucomicrobium</i>
Phylum <i>Dictyoglomus</i>	<i>Dictyoglomus</i>

The classification presented in 9th eds. of Bergey's manual of determinative bacteriology (1994) is especially designed to be used of the identification of bacteria and is different from the classification system presented in Bergey's manual of systematic bacteriology.

In this edition bacteria have been characterized into 35 groups under above 4 major categories. The first category include group 1 to 16 (ex. Spirochaetes, sulphate and sulphur reducing bacteria, rickettsias and chlamydias)

The second category include group 17 to 29 (ex. Gram positive cocci, endospore forming gram positive rods and cocci, non sporing gram positive rods)

The third category include the group 30 (*Mycoplasma*). The last or fourth category include group 31 to 35 (Ex. Methanogens, Archaeal sulphate reducers, extremely halophiles, cell wall less archaebacteria)

The most recent revision of Bergery's manual divides bacteria into four division (or phyla) according to the characteristics of cell wall which division is subdivided into sections to such characters like gram stain reactions, cell shape, cell arrangements, oxygen requirement, motility and nutritional and metabolic properties. Each section consist of a number of genera. In some sections, genera are grouped into families and orders in other sections, they are not.

Four Major Categories

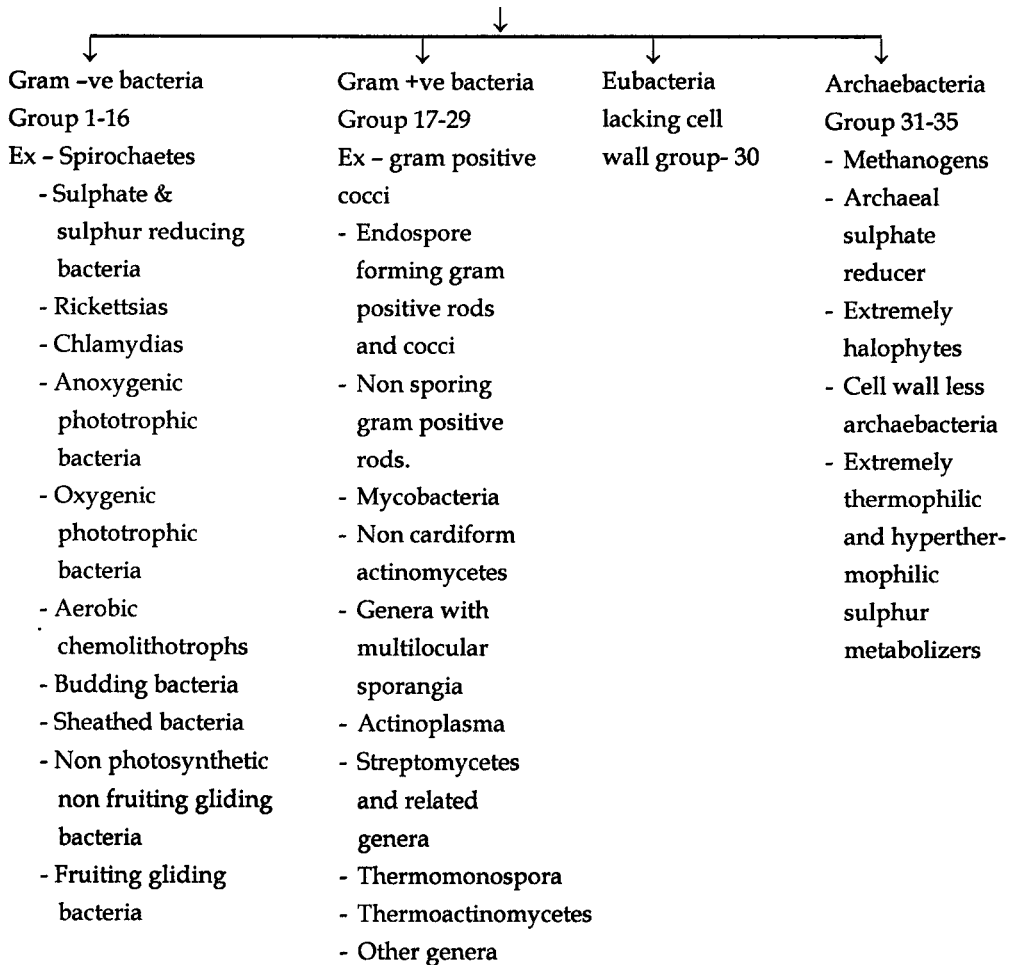

The Bergey's manual of systematic bacteriology has four volumes which contain the bacteria considered to be of practical importance and in medicine, or those that illustrate biologically unusual or interesting principles. The details of above four volumes are summarized below:-

- Vol 1 : It include gram -ve bacteria (section 1-11) (1984)
- Vol 2 : It include gram +ve bacteria, photrophic and other specialized bacteria including gliding bacteria (section 12-17) (1986)
- Vol 3 : It include bacteria with unusual cell wall like Archae-bacteria (section 18-25) (1989)
- Vol 4 : It include Actinomycetes and other filamentous bacteria (section 26 - 33) (1991)

All of four volumes contain the organism with prokaryotic or primordial nucleus and are kept in single kingdom Prokaryote

Vol-I

Section-I - The Spirochaetes (they are unicellular chemoheterotrophic with helical morphology, cell body highly flexible, motility by axial filaments, aquatic or animal parasites. Pathogen to man causes Syphilis (*Treponema pallidum*))

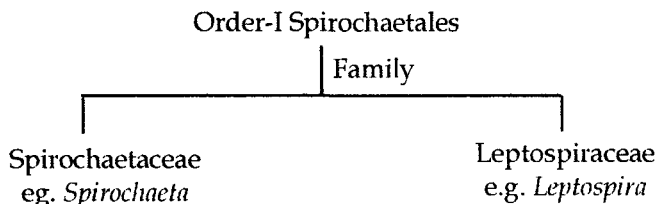

- Section 2. Aerobic/Microaerophilic, motile, helical/vibroid Gram-negative bacteria.
(Helical morphology, motility by flagella not by axial filaments, vibroids do not have a complete turn, include N₂ fixing bacteria and some pathogens, generally terrestrial and aquatic, pathogen in human intestinal tract and oral cavity eg. *Spirillum*, *Azospirillum*, *Campylobacter*, *Bdellovibrio*)
- Section 3. Nonmotile (or rarely motile), Gram - negative, curved bacteria [(mostly aquatic, and sedimentary environments), non pathogenic form S-shapes, C-shapes, rings]
 - Family I. Spirosomaceae, e.g. *Spirosoma*
- Section 4. Gram - negative Aerobic Rods and Cocci (terrestrial, aquatic and animal parasites, contain organisms of medical, industrial and environmental importance)
 - Family I. Pseudomonadaeae e.g. *Pseudomonas*
 - Family II. Azotobacteriaceae e.g. *Azotobacter*
 - Family III. Rhizobiaceae e.g. *Rhizobium*
 - Family IV. Methylococcaeae, e.g. *Methylococcus*
 - Family V. Halobacteriaceae e.g. *Halobacterium*
 - Family VI. Acetobacteriaceae e.g. *Acetobacter*
 - Family VII. Legionellaceae e.g. *Legionella*

Family VIII. Neisseriaceae e.g. *Neisseria*, *Beijerinckia*

Section 5. Facultatively Anaerobic Gram-negative Rods (terrestrial plant and animal pathogen and form normal microflora of intestinal tract of humans and cattles and other are imp. pathogens.)

Family I. Enterobacteriaceae e.g. *Escherichia*, *Shigella*, *Yersinia*

Family II. Vibrionaceae e.g. *Vibrio*

Family III. Pasteuellaceae e.g. *Actinobacillus*, *Haemophilus*

Section 6. Anaerobic gram-negative straight, curved and helical rods (found as pathogens on animals and insects, obligate anaerobes, mostly of intestinal tract, some in mouth and genital tract).

Family I. Bacteroidaceae e.g. *Bacteroides*

Section 7. Dissimilatory sulphate or sulphur – reducing bacteria

(Anaerobic, found in sediments, reduce oxidized forms of sulphur to H_2S) ex. *Desulfovibrio*

Section 8. Anaerobic Gram- negative cocci (Mostly in animal intestinal tract, non motile anaerobes).

Family I. Veillonellaceae e.g. *Veillonella*

Section 9. The Rickettsias and Chlamydias (Obligate intracellular parasites of arthropods and animals)

Order I. Rickettsiales (obligate parasite of arthropods, also called spotted fever group)

Family I. Rickettsiaceae e.g. *Rickettsia*

Family II. Bartonellaceae e.g. *Bartonella*

Family III. Anaplasmataceae e.g. *Anaplasma*

Order II. Chlamydiales e.g. *Chlamydia* (parasite on birds, only two sps known)

Family I. Chlamydiaceae

Section 10. The Mycoplasmas (Pleomorphic group lacking cell wall, parasite of animal, plant and insects)

Division Tenericutes

Class I. Mollicutes

Order I. Mycoplasmatales

Family I. Mycoplasmataceae e.g. *Mycoplasma*

Family II. Acholeplasmataceae e.g. *Acholeplasma*

Family III. Spiroplasmataceae e.g. *Spiroplasma*

Section 11. Endosymbionts (Assorted bacteria that live symbiotically in protozoa, insects and fungi helminthes and plants etc)

A. Endosymbionts of protozoa, ciliates, flagellates, amoebae

B. Endosymbionts of Insects

C. Endosymbionts of Fungi and invertebrates other than Arthropods

Section 12. Gram-positive cocci (terrestrial, pathogen of skin, mucous membranes of animals) ex. *Staphylococcus streptococcus*.

Family I. Micrococcaceae e.g. *Micrococcus*

Family II. Deinococcaceae e.g. *Deinococcus*

Section 13. Endospore forming Gram-positive rods and cocci (terrestrial, pathogen to animal intestinal tract, aerobic or facultative anaerobes).

For example, *Bacillus*, *Clostridium* etc.

Section 14. Regular, non sporing, Gram-positive rods (Industrially important microbes especially in dairy industry where they convert carbohydrate to lactic acid, found in genital and oral cavities and animal faces)

For example, *Lactobacillus*, *Renibacterium* and *Listeria* (animal pathogen)

Section 15. Irregular, Non sporing, gram-positive (Human pathogen, soil organism with pleomorphic morphology)

For example: *Cornynebacterium*, *Microbacterium*, *Actinomyces*

Section 16. The mycobacteria (terrestrial, important animal pathogen, shows acid fast reaction)

Family: Mycobacteriaceae e.g. *Mycobacterium*

Section 17. Nocardioforms (form branched filaments, soil and some animal pathogen, reproduce by fragmentation often acid fast)

For example, *Nocardia*, *Rhodococcus*

Section 18. An oxygenic, phototrophic bacteria (found in anaerobic sediments, includes green and purple sulphur and non sulphur bacteria (uses H₂S as e- donor and release sulphur)

I. Purple bacteria

Family I. Chromatiaceae e.g. *Chromatium*

Family II. Ectothiorhodospiraceae
e.g. *Ectothiorhdorphila*

Purple non-sulphur bacteria

e.g. *Rhodospirillum*, *Rhodobacter* etc.

II. Green bacteria

Green sulphur bacteria

e.g. *Chlorobium*, *Chloroherpetom* etc.

Multicellular, filamentous, Green bacteria

For example, *Chloroflexus*, *Heliobacter*, etc.

III. General Incertae Sedis

For example, *Heliobacterium* and *Erythobacter*

Section 19 Oxygenic Photosynthetic Bacteria (Also called cyanobacteria) (aquatic, produces O₂ during photosynthesis, many sps fix atmospheric N₂)

Group I: Cyanobacteria

Subsection I Order: Chroococcales

Subsection II Order: Pleurocapsales

Subsection III Order: Oscillatoriales

Subsection IV Order: Nostocales

Subsection V Order: Stigonematales

Group II: Order: Prochlorales

Family Prochloraceae

For example *Prochloron* and
Prochlorothrix

Section 20 Aerobic Chemolithotrophic Bacteria and associated organisms (A large group of bacteria found in soil, nitrifying and sulphur oxidizing bacteria, agriculturally and environmentally important)

A. Nitrifying Bacteria

Family Nitrobacteriaceae

— Nitrite-oxidizing bacteria
e.g. *Nitrobacter*, *Nitrospira*,
Nitrospira etc.

— Ammonia- Oxidizing, bacteria
e.g. *Nitrosomonas*, *Nitrosococcus*,
Nitrospira, *Nitrosolobus*,
Nitrosovibrio

B. Colourless sulphur Bacteria

For example, *Thiobacterium*, *Macromonas*, *Thiospira* etc.

C. Obligately Chemolithotrophic hydrogen bacteria

e.g. *Hydrogenobacter*

D. Iron and manganese-Oxidizing and/or depositing bacteria

Family Siderocapsaceae (e.g. *Siderocapsa*)

E. Magnetotactic bacteria

e.g. *Aquaspirillum magnetotacticum* and *Bilophococcus*

Section 21. Budding and/or Appendaged Bacteria (Mostly aquatic some in soil, possess prosthecae, reproduces by budding, some are stalked)

I. Prosthecate Bacteria

A. Budding bacteria

1. Buds produced at tip of prostheca e.g. *Hyphomonas*
2. Buds produced on cell surface e.g. *Prosthecomicrobium*

B. Bacteria that divide by binary transverse fission

e.g. *Caulobacter*, *Prosthecobacter*

II. Non-Prosthecate Bacteria

A. Budding bacteria

1. Lack Peptidoglycan e.g. *Planctomyces*
2. Contain peptidoglycan e.g. *Ensifer*, *Blastobacter*

B. Non-budding stalked bacteria e.g. *Gallionella*, *Nevskia*

C. Other bacteria

1. Nonspinate bacteria e.g. *Seliberia*, *Thiodendron*
2. Spinate bacteria

Section 22. Sheathed Bacteria (Generally aquatic and cause of sewage treatment problems, the cell is incased in hollow sheath)

For example, *Sphaerotilus*, *Leptothrix*, *Clonothrix*

Section 23. Non photosynthetic, Non fruiting Gliding Bacteria (Aquatic some sps like *cytophaga* degrade cellulose whereas *Beggiatoa* oxidize H₂S)

Order I. Cytophagales

Family I. Cytophagaceae e.g. *Cytophaga*,
Capnocytophaga

Order II. Lysobacterales

Family I. Lysobacteriaceae
e.g. *Lysobacter*

Order III. Beggiatoales

Family I. Beggiatoaceae
e.g. *Beggiatoa*, *Thiothrix*, *Thioploca*

Other families

Family Simonsiellaceae

Family Pelonemataceae

Section 24. Fruiting Gliding Bacteria (The Myxobacteria) (found in dung and soil, cells aggregate to form a fruiting body eg. *Myxococcus*)

Order Myxococcales

- Family I. Myxococcaceae e.g. *Myxococcus*
- Family II. Arthangiaceae e.g. *Archangium*
- Family III. Cystobacteriaceae e.g. *Cytobacter*
- Family IV. Polyangiaceae e.g. *Potyngium*

Section 25. Archaeobacteria (Anaerobic, found in sediments and environments of extreme temperature and osmotic pressure, not related to any other bacterial group because packing peptidoglycan in their cell wall)

- Group I. Methanogenic Archacobacteria
- Order I. Methanobacteriales
- Family I. Methanobacteriaceae
e.g. *Methanobacterium*
- Family II. Methanothermaceae
e.g. *Methanothermus*
- Order II. Methanococcales
- Family Methanococcaceae e.g. *Methanococcus*
- Order III. Methanomicrobiales
- Family I. Methanomicrobiaceae
e.g. *Methanomicrobium*
- Family II. Methanosarcinaceae
e.g. *Methanosarcina*, *Methanolobus*
- Group II. Archaeobacterial : Sulphate Reducers
- Order Archaeoglobales
- Family Archaeoglobaceae e.g. *Archaeoglobus*
- Group III. Extremely Halophilic Archaeobacteria
- Order Halobacteriales
- Family Halobacteriaceae e.g. *Halobacterium*,
Halococcus, *Haloferax* etc.
- Group IV. Cell wall-less archaeobacteria
e.g. *Thermoplasma*
- Group V. Extremely Thermophilic sulphate-
metabolizers
- Order I. Thermococcales
- Family Thermococcaceae e.g. *Thermococcus*
- Order II. Thermoproteales

- | | |
|------------|---|
| Family I | Thermocproteaceae
e.g. <i>Thermoproteins</i> |
| Family II. | Desulfurocaccaceae
e.g. <i>Desulfurococcus</i> |
| Order III. | Sulfolobales |
| Family | Sulfolobaceae e.g. <i>Sulfolobus</i> |
- Section 26 Nocardioform Actinomycetes (filamentous with hyphage typically fragmented)
e.g. *Nocardia*, *Rhodococcus*, *Saccharomonospora*
- Section 27 Actinomycetes with multilocular Sporangia (Strictly associated with root of non leguminous plant and form root nodules)
e.g. *Frankia*, *Dermatophilus* (produce motile spores cause dermatitis of the dorsal skin in sheep)
- Section 28 Actinoplanetes (spores are borne in sporangia)
For example, *Actinoploanes*, *Micromonospora*
- Section 29 Streptomycetes and related genera (permanent mycelia, hyphae non fragmented, aerial mycelium with chain of spores with 5 – 50 or more conidia per chain, medically important group because the members of this section produces many effective antibiotics) some group degrade cellulose, chitin and other recalcitrant natural substances)
e.g. *Streptomyces*, *Kineosporia*
- Section 30. Maduromycetes (hyphage non fragmented, conidia borne singly or in pairs/ short chains)
e.g. *Actinomadura*, *Microbisora*, *Microtetraspora*,
Streptosporangium
- Section 31. Thermomonospora and Related Genera (conidia borne in pairs)
e.g. *Thermomonospora*, *Nocardiopsis*
- Section 32. Thermoactinomycetes (conidia borne in short chains)
e.g. *Thermoactinomyces*
- Section 33. Othera Genera
e.g. *Pasteuria*, *Saccharothrix*, *Kibdelosporangium*

As seen from Table 1, Volume 1 of second of Bergey's Manual contain the two domains Archaea and the phototrophic bacteria. The important phyla described are:

1. **Phylum** : Aquificae (contain autotrophic bacteria, use hydrogen for energy production, contain most thermophilic organism and known as earliest branch of the bacteria) Ex. *Hydrogenobacter*, *Aquifix*.

2. **Phylum** : Thermotogae (anaerobic, thermophilic, fermentative, gram -ve bacteria with unusual fatty acids) Ex . *Thermotoga*

3. Phylum : *Dienococcus thermus* (radiation resistant, gram positive, high concentration of carotenoid pigments) Ex. *Dienococcus*.

4. Phylum : Chloroflexi (gram -ve, green non sulphur bacteria, have unusual peptidoglycan and lack lipopolysaccharide) Ex. *Chloroflexus*, *Herpetosiphon*.

5. Phylum : Cyanobacteria (oxygenic photosynthetic bacteria, unicellular, filament, branched or unbranched. Ex. *Nostoc*, *Anabaena*.

6. Phylum : Chlorobi - (Anoxygenic photosynthetic bacteria known as green sulphur bacteria Ex. *Chlorobi*.

Volume 2 of second edition is devoted completely to gram - ve proteobacteria (called purple bacteria). It is large and extremely complex group containing 1,300 sps and 400 genera Nutritionally they are phototrophic, heterotrophic and chemolithotrophic. The phylum proteobacteria is divided into 5 classes on the basis of rRNA data. It is believed that whole phylum arise from a photosynthetic ancestor and many strains lost photosynthesis when adopting metabolically to new ecological niches (Table 1).

Class I : Alphaproteobacteria (most of the oligotrophic forms able to grow at low nutrient levels), some are methyletrophic, chemolithotropic, N₂ fixation and few are pathogens. Ex. *Methylobacterium*, *Nitrobacter*, *Rickettsia* and *Brucella*.

Class II : Betaproteobacteria (it overlap the α subdivision metabolically, they generally use the substance that diffuse from organic decomposition in the anaerobic zone of habitats. Ex. *Nitrosomanas*, *Alcaligenes*, *Methylobacillus*.

Class III : Gammaproteobacteria (large and complex group with 14 orders and 25 families, chemoorganotrophic, facultatively anaerobic and fermentive, they use both i.e. Embden Meyerhoff as well as Pentose phosphate pathway for energy metabolism, few are photosynthetic methylotrophic or sulphur oxidizing e.g. *Chromatium*, *Methylococcus*.

Class IV : Deltaproteobacteria (contain seven orders and eighteen families. Some are predators on other bacteria Ex. *Mysococcus*, *Bdellovibrio*, and *Desulfovibrio*.

Class V : Epsilonproteobacteria (composed only of one order, with two important pathogenic genera ex. *Campylobacter* and *Helicobacter*.

Volume 3 of Bergey's Manual surveys the gram + ve bacteria with low G + C content in their DNA. It includes the phylum firmicutes. Most of the bacteria are gram positive and heterotrophic. Some are rods, others are cocci, mycoplasma are pleomorphic. Endospores may be present (Table I).

Class I : Clostridia - (contain 3 orders and 11 families members are anaerobic vary in their morphology Ex. *Clostridium*, *Desulfotomaculum*.

Class II : Mollicutes (contain five order and six families, commonly called mycoplasma, lacking cell wall, pleomorphic, helical or branched filament, non motile, gram -ve, requires sterols for their growth Ex. *Mycoplasma*, *Spiroplasma*.

Class III : Bacilli (large class comprises of gram + ve, aerobic or facultatively anaerobic, rods and cocci, contain many medicinally and industrially important genera. Ex. *Bacillus*, *Lactobacillus*, *Streptococcus*, *Listeria*.

Volume four is devoted to high G + C content, gram positive, contain the phylum Actinobacteria, some are cocci, other are regular or irregular rods. High G + C gram positive called actinomycetes often form complex branching hyphae. The composition of peptidoglycan varies greatly. Mycobacteria produce large mycolic acids. There are five subclass. Ex. *Actinomyces*, *Corynebacterium*, *Micrococcus*.

Classification of Prokaryotes based on Bergey's Manual of Systematic Bacteriology, 2nd Edition (Table 1)

Domain Archaea

Phylum AI. Crenarchaeota

Class : Thermoprotei

**Order : Thermoproteales,
Desulfurococcales, Sulfolabales**

ex. *Thermoproteus*

Pyrobaculum

Pyrodictium

Sulfolobus

Class : Thermoplasmata

Order : Thermoplasmatales

Thermoplasma

Picrophilus

Ferroplasma

Class : Thermiococci

Order : Thermococcales

Ex. *Thermococcus*, *Pyrococcus*

Phylum AII. Euryarchaeota

Class: Methanobacteria

Order: Methanobacteriales

Methanobacterium

Methanobrevibacter

Methanothermus

Class :Methanococci

Order : Methanococcales

Methanococcus

Methanothermococcus

Methanomicrobium

Methanospirillum

Methanosarcina

Class : Halobactria

Order : Halobacteriales

Halobacterium

Halococcus

Natranomonas

Natranococcus

Class : Archaeoglobi

Order : Archaeoglobales

Archaeoglobus

Ferroglobus

Class : Methanopyri

Order : Methanopyrates

Methanopyrus

Domain Bacteria

Phylum BI. Aquificae

Class : Aquificae

Order : Aquificales

Aquifex

Hydrogenobacter

Phylum BII. Thermotogae

Class : Thermotogae

Order : Thermotogales

Thermotoga

Geotoga

Petrotoga

Phylum BIII. Thermodesulfobacteria

Class : Thermodesulfobacteria
Order : Thermodesulfobacteriales
Thermodesulfobacterium

Phylum BIV. 'Deinococcus-thermus'

Class : Deinococci
Order : Deinococales
Deinococcus
Thermus

Phylum BV. Chrysiogenetes

Class : Chrysiogenetes
Order : Chrysiogenetales
Chrysiogenes

Phylum BVI. Chloroflexi

Class : Chloroflexi
Order : Chloroflexales
Chloroflexus
Heliothrix

Phylum BVII. Thermomicrobia

Class : Thermomicrobia
Order : Thermomicrobiales
Thermomicrobium

Phylum BVIII. Nitrospira

Class : Nitrospira
Order : Nitrospirales
Nitrospira
Thermodesulfovibrio

Phylum BIX. Deferribacteres

Class : Deferribacteres
Order : Deferribacteriales
Deferribacter

Phylum BX. Cyanobacteria

Class : Cyanobacteria
 Mentioned separately in chapter
 14

Chroococcus
Microcystis
Lyngbya
Oscillatoria
Spirulina
Anabaena
Nostoc
Scytonema
Calothrix
Rivularia
Stigonema

Phylum BXI. Chlorobi

Class : Chlorobia
Order : Chlorobiales
Chlorobium

Phylum BXII. Proteobacteria

Class I : Alpha Proteobacteria
Order : Rhodospirillales
Rhodospirillum
Azospirillum
Acetobacter
Glucanobacter
Order : Rickettsiales
Rickettsia
Ehrlichia
Holospora
Order : Rhodobacteriales
Rhodobacter

Order : Sphingomanadales*Sphingomonas**Zygomonas***Order : Caulobacteriales***Caulobacter***Order : Rhizobiales***Rhizobium**Agrobacterium**Sinorhizobium**Bartonella**Brucella**Phyllobacterium**Methylocystis**Beijerinckia**Derxia**Bradyrhizobium**Nitrobacter**Rhodopseudomonas**Hypomicrobium**Azorhizobium**Methylobacterium**Rhodobium***Class II. Beta Proteobacteria****Order : Burkholderiales***Burkholderia**Thermothrix**Alcaligenes**Achromobacter**Bordetella***Order : Hydrogenophilales***Hydrogenophilus**Thiobacillus***Order : Methylophilales***Methylophilus***Order : Nessirealis***Neisseria***Order : Nitrosomonadales***Nitrosomonas**Spirillum***Order : Rhodocyclales**

Family : Rhodocyclaceae

Ex. *Rhodocycles*, *Azospira***Order : Procabacteriales**

Family : Procabacteriaceae

Ex. *Procabacter***Class III. Gamma Proteobacteria****Order : Chromatiales***Chromatium***Order : Acid thiobacillales**Ex. *Acid thiobacillus***Order : Xanthomonadales***Xanthomonas***Order : Cardiobacteriales***Cardiobacterium***Order : Thiotrichales***Thiothrix***Order : Legionellales***Legionella***Order : Methylococcales***Methylococcus***Order : Pseudomonadales***Pseudomonas***Order : Vibrionales***Vibrio***Order : Enterobacteriales***Enterobacter**Escherichia**Erwinia*

*Klebsiella**Proteus**Salmonella**Serratia**Shigella**Yersinia***Order : Pasteurellales***Pasteurella***Class IV : Delta Proteobacteria****Order : Desulfurellales***Ex. Desulfurella***Order : Desulfovibrionales***Desulfovibrio***Order : Desulfobacterales***Desulfococcus**Desulfosarcina***Order : Desulfobacterales***Desulfobulbus***Order : Desulfuromonadales***Desulfomonas***Order : Bdellovibrionals***Bdellovibrio**Bacteriovorax***Class V. Epsilon Proteobacteria****Order : Campylobacterales***Campylobacter**Helicobacter***Phylum BXIII. Firmicutes****Class : Clostridia****Order : Clostridiales***Clostridium**Anaerobacter**Lachnospira**Peptostreptococcus**Eubacterium**Peptococcus**Helicobacterium**Helicococcus**Acidaminococcus**Syntrophomonas***Order : Thermoanaerobacteriales***Thermoanaerobacterium***Class : Mollicutes****Order : Mycoplasmatales***Mycoplasma**Ureaplasma***Order : Entomoplasmatales***Entomoplasma**Spiroplasma***Order : Acholeplasmatales***Achleoplasma***Order : Anaeroplasmatales***Anaeroplasma***Class : Bacilli****Order : Bacilliales***Bacillus**Planococcus**Caryophanon**Listeria**Staphylococcus**Penibacillus**Brevibacillus**Thermobacillus**Thermoactinomyces***Order : Lactobacillales***Lactobacillus**Pedicoccus**Enterococcus**Leuconostoc**Streptococcus*

Phylum BXIV. Actinobacteria

Class : Actinobacteria

Order : Acidimicrobiales

Actinomicrobium

Rubrobacter

Coriobacterium

Order : Actinomycetales

Actinomyces

Micrococcus

Arthrobacter

Cellulomonas

Corynebacterium

Mycobacterium

Nocardia

Micromonospora

Actinoplanes

Dactylosporangium

Spirilliplanes

Propionibacterium

Actinosynnema

Streptomyces

Kitasatospora

Streptovercillium

Streptosporangium

Microbispora

Microtetraspora

Thermomonospora

Spirillospora

Frankia

Geodermatophilus

Order : Bifidobacteriales

Ex. *Bifidobacteria*, *Falcivibrio*

Phylum BXV. Planctomycetes

Class : Planctomycetacia

Order : Planctomycetales

Planctomyces

Gemmata

Phylum BXVI. Chlamydiae

Order : Chlamydiales

Chlamydia

Parachlamydia

Simkania

Waddlia

Phylum BXVII. Spirochaetes

Class : Spirochaetes

Order : Spirochaetales

Spirochaeta

Borrelia

Cristispira

Treponema

Serpulina

Laptonema

Leptospira

Phylum BXVIII. Fibrobacteres

Class : Fibrobacteres

Order : Fibrobacterales

Fibrobacter

Phylum BXIX. Acidobacteria

Class : Acidobacteria

Order : Acidobacteriales

Acidobacterium

Geothrix

Holophaga

Phylum BXX. Bacteroidetes

Class : Bacteroidetes

Order : Bacteroidetales

Bacteroides

Porphyromonas

Class : Flavobacteria

Order : Flavobacteriales

Flavobacterium

Bergeyella

Myroides

Blattabacterium

Class : Sphingobacteria

Order : Sphingobacteriales

Sphingobacterium

Saprospira

Flexibacter

Flammiovirga

Crenothrix

Phylum BXXI. Fusobacteria

Class : Fusobacteria

Order : Fuscobacteriales

Fusobacterium

Cetobacterium

Phylum BXXII. Verrucomicrobia

Class : Verrucomicrobiae

Order : Verrucomicrobiales

Verrucomicrobium

Prostheco bacter

Xiphinematobacter

Phylum BXXIII. Dictyoglomus

Class : Dictyoglomi

Order : Dictyoglomiales

Dictyoglomus

Volume 5 describes an assortment of nine phyla that are located here for more convenience. The inclusion of these groups in volume five does not simply that they are directly related. All of them are gram -ve bacteria variable in morphology, physiology and life cycle pattern. The four important phyla are briefly described:

1. **Phylum : Planctomycetes** (related to chlamydias according to rRNA sequences they contain only one order (are coccoid to avoid or pear shaped that lack peptidoglycan, normally unicellular, divide by budding and may produce non prosthecate appendages called stalks, grow in aquatic habitats.) Ex. - *Isosphaera*

2. **Phylum : Chlamydiae** (small phylum, obligate, intracellular parasite with unique life cycle involving two distinctive stages- elementary bodies and reticulate bodies, small coccid form with no appendages. Important pathogen and cause many human diseases).

3. **Phylum Spirochaetes** : (contain helically shaped, motile, gram - ve bacteria with unique morphology and motility, chemoheterotroph, free living, symbiotic, parasitic. It has special exterior boundry the outer membrane that surrounds the protoplasmic cylinder. Several important human pathogens). Ex. Spirochaetes

4. **Phylum : Bacteroidetes** - (it has three classes, Ex. - Bacteroides, Flavobacterium, Flexibacter.)

Thus Bergey's manual is the principle resource in prokaryotic, taxonaomy and is used by microbiologists around the world.

Finally, it is emphasized that prokaryotic nomenclature is as much in flux as classification. The names of families and genera are fairly well established and stable in the new system (At least in the absence of future discoveries).

6

BACTERIA

The word bacterium (Gk. Bakterion = little rod) originally applied by microscopists for rod shaped organism, belonging to the lowest order of the plant life or "microscopic unicellular plants without chlorophyll that reproduce by fission".

Antony Von Leuwenhoek (1632 - 1723), the dutch dry goods merchant of Holland, is credited with the discovery of bacteria. He observed bacteria in the scum of teeth with the help of microscope constructed by himself. He named them as "tiny animalcules". In 1695 he published his work "The secrets of nature discovered by Antony Van Leeuwenhoek" for this discovery he has been called as "Father of Bacteriology".

Later Ehrenberg (1829) coined the term bacteria for these microorganism. The term bacteria literally means, small stick.

Carl Weigert (1845-1904) developed the staining technique for bacteria. T.J. Bwoul (1878) said that the bacteria causes diseases in plants.

General Characters of Bacteria

Bacteriology is the branch of botany under which we study the metabolism and reproduction of bacteria. The general characters of bacteria are:

1. They are omnipresent i.e. present in soil, air and water.
2. They are unicellular, prokaryotic microorganism.
3. The cell bears a thick rigid cell wall outside the plasma membrane (because of this character they are kept in plant kingdom).
4. They have great variation in the mode of nutrition i.e. may be autotrophic and heterotrophic. In heterotrophism mode of nutrition they may be parasite saprophyte or symbiotic in nature.

5. They lack true chlorophyll but few photosynthetic bacteria have a special type of chlorophyll called bacteriochlorophyll.
6. Because of the prokaryotic nature they lack true nucleus (lacking nuclear membrane and nucleolus), genetic material is in the form of composite structure known as genophore/nucleoid/incipient nucleus.
7. The cell wall of bacteria is made up of mucopeptide unlike the cell wall of plants (where it is made up of cellulose)
8. They lack mitochondria, golgi apparatus, plastid and endoplasmic reticulum.
9. They lack basic protein histone in their DNA.
10. Ribosomes are of 70s type.
11. At some places the plasma membrane invaginate in folds to form mesosomes.
12. All the enzymes required for respiration are found in the cell membrane.
13. Both DNA and RNA are present in the bacterial cell. DNA is in the form of single circular chromosome (therefore the cell is haploid)
14. Vegetative reproduction is generally by binary fission, cyst, budding and gonidia.
15. Asexual reproduction is by conidia, motile spores and endospore.
16. True sexual reproduction is absent in bacteria but there are examples of genetic recombination which may be of following types viz. conjugation, transduction and transformation.

Plant like characteristic in bacteria

Cohn (1872) reported the presence of cell wall in bacteria (which is a character similar to plants). Along with this the various factor responsible for keeping bacteria in plant kingdom are as follows:

- (i) The cell wall is made up of cellulose in few bacteria.
- (ii) They show filamentous growth like some plants.
- (iii) Like plant autotrophic bacteria produces carbonic food by the use inorganic substances (CO_2 and H_2O).
- (iv) Structure and some mode of reproduction of bacteria is similar to some members of thallophyta.
- (v) They absorb the nutritional substances in the soluble form through their cell wall (like plants).
- (vi) Bacteria has the ability to convert inorganic nitrogen into all types of $-\text{NH}_2$ acids.
- (vii) Most of the transitional forms of bacteria and fungi are found in the nature.

Similarities between Bacteria and Blue Green Algae :

1. Both groups bears a prokaryotic nucleus.

2. Both are unicellular or colonial and the complicated structures are in filamentous form.
3. Both groups have similar cell wall structure and cell division.
4. Both lack the typical cellular organelles found in eukaryotic cells.
5. Genetic material is DNA without histone proteins.
6. Cells are surrounded by gelatinous sheath.
7. Both have similar cell forms viz. spherical, cylindrical and spiral.
8. No zoospores are formed during asexual reproduction in blue green algae and bacteria.
9. Members of both the groups can withstand desiccation and high temperatures.
10. Like saprophytic bacteria, blue green algae can live on dead organic matter in the absence of light.
11. Genetic recombination is present in both blue green algae and bacteria.

Dissimilarities between Cyanobacteria and Bacteria :

1. Cyanobacteria are always aflagellate while most of the bacteria are flagellate.
2. All cyanobacteria are aerobic while many bacteria are anaerobic.
3. All cyanobacteria have chlorophyll a for photosynthesis while bacteria bears bacteriochlorophyll.
4. The source of hydrogen is H_2S in bacteria whereas it is H_2O in cyanobacteria.

DISTRIBUTION

Bacteria are ubiquitous/omnipresent in their distribution. They are found in all the natural habitats i.e. soil, water and air. They occur in all the situations except in pits of volcanoes, deep strata or rock and rain water, distilled water in deep wells, blood of normal animals. They constitute a major part of the soil microflora and intestine of animals. Viz. *E. coli* in the intestine of human being. Some species have been found in extreme hot spring as well as extreme cold condition, these are referred to as thermophilic (survive on $78^{\circ}C$) and psychrophilic (on $-190^{\circ}C$) respectively. They can tolerate and remain alive at a pH lower than 1 at one end and 13 at another end. Generally 1 gm soil contains about 1000-10 million bacteria.

Bacteria also occurs in a variety of foods and food products viz fruit, vegetables, milk, butter, cheese and milk beverages.

STRUCTURE OF BACTERIAL CELL

Size : There is great variation in size of bacteria. They are so minute which can't be seen without the help of microscope. On an average each cell of bacterium measures $1.25 - 2 \mu m$ in diameter and $2-10 \mu m$ in length. Cocci are about $0.5-2.5 \mu m$ in diameter while bacilli are $0.3-15 \mu m \times 0.2 -2 \mu m$. The smallest rod shaped eubacterium is *Dialister pneumosintes* which measure in between $0.15 \mu m - 0.3 \mu m$ in size. The biggest bacteria *Beggiatoa mirabilis* is about $16-45 \mu m$ in diameter and $80 \mu m$ in length.

SHAPES AND FORMS OF BACTERIA

Bacterial cells differ in their shapes but usually three conventional shapes have been recognized. Initially the classification of bacteria was based on their shapes but now it is not used. The various shapes are as follows:

(1) Ellipsoidal/Spherical/Cocci

The term cocci has originated from a greek word; kokkos = grain or kernel. It is the simplest form of bacteria in which bacteria appears like a minute sphere (0.5μ - 1.25μ in diameter) they lack flagella. On the basis of arrangements cocci are further classified as follows:

1. **Micrococci** : When a bacterium appears singly e.g. *Micrococcus agitis*, *M. aureus*.
2. **Diplococcus** : When they appear in a pairs of cells e.g. *Diplococcus pneumoniae*.
3. **Streptococci** : When they appear in rows of cells or in chains e.g. *Streptococcus lactis*.
4. **Staphylococci** : When they arrange in irregular clusters like bunches of grapes e.g. *Staphylococcus aureus*.
5. **Tetracoccus**: When they arrange in a sequence of four e.g. *Neisseria* and *Micrococcus tetrogenus*.
6. **Sarcinae**: When they arrange in cuboidal or in a different geometrical or packet arrangements e.g. *Sarcinae lutea*.

(2) Rod Shaped Bacteria or Bacillus

The word bacillus originated from greek word, bacilli means rod or stick. There ends are rounded flat or pointed. There size ranges from 0.5 - 1.2μ in diameter and 3 - 7μ in length. They may be flagellated or non-flagellated. Most of the bacteria causing disease in plants belongs to bacilli category. They may be of following types:

- (i) **Monobacillus** : When they arrange singly.
- (ii) **Diplobacillus** : When they are present in a group of two e.g. *Diplobacillus pneumoniae*.
- (iii) **Streptobacillus** : When they appear in chains e.g. *Bacillus tuberculosis*.
- (iv) **Palisade** : Very rarely the bacillus arrange in a palisade arrangement.

(3) Spiral or Helical

The origin of word is from greek word; spira means coiled. They appear like a cork screw. A single spirillum has more than one turn of helix. Generally they are found as free living, unicellular entity. There size ranges from 10 - 50μ in length and 0.5 - 3μ in diameter. They are flagellated e.g. *Spirillum minus*, *S. volutans*.

(4) Vibrio or Coma

The bacteria of this group are like 'coma or small curved rod. They bear flagella

at their end. Their size ranges from 1.5-1.7 μ in diameter and upto 10 μ in length e.g. *Vibrio cholerae*.

(5) Spirochaeta

These bacteria appears like a cork screw and atrichous. Their length is more as compared to their diameter. Their body is more flexible.

(6) Filamentous

These type of bacteria are generally found in sewage water and the water coming out from sugar industry or effluent of sugar industry e.g. *Sphaerotilus natans*. Basically they are rod shaped bacilli which grow in an elongated chain and are covered by a tubular envelope. Ferrous containing water generally contain filamentous bacteria e.g. *Leptothrix*, *Cladothrix*, *Nocardia* and *Beggiatoa*.

(7) Stalked

These bacteria are enveloped by a extra cellular structure which encloses the entire cell. This structure is known as prosthecae which is a slightly hard appendage appendacular structure. Because of the presence of Prosthecae they are known as prosthecate bacterium. These bacteria are classified in following two groups.

(a) The bacteria in which prosthecae does not take part in reproduction e.g. *Colobacter*.

(b) The bacteria where prosthecae participate in reproduction e.g. *Hypomicrobium*.

There stalk is about 20 μ in length and are formed in nutrient media rich in phosphate. The basal end of the stalk is either knobbed structure or sticky in nature. Many colobacter cells unite with their lower basal knob and arrange like the petals of a rose.

(8) Pleomorphic

Many bacteria change their shape and structure with the change in environmental conditions. These bacteria which are found in various forms are known as pleomorphic bacteria e.g. *Acetobacter*.

(9) Budding Bacteria

These are of football shaped structure with a swollen part and a thin tube. This tube gradually increases in size and its terminal end swells up to form new cell which is globular and ultimately a net work of cell is formed e.g. *Rhodomicrobium*.

ULTRASTRUCTURE OF BACTERIAL CELL

As bacterial cells are very minute, they are studied under electron microscope in which it reveals various structures. Some of these are external to the cell wall while other are internal to the cell wall. The brief descriptions of the readily evident structures of bacteria is as follows :

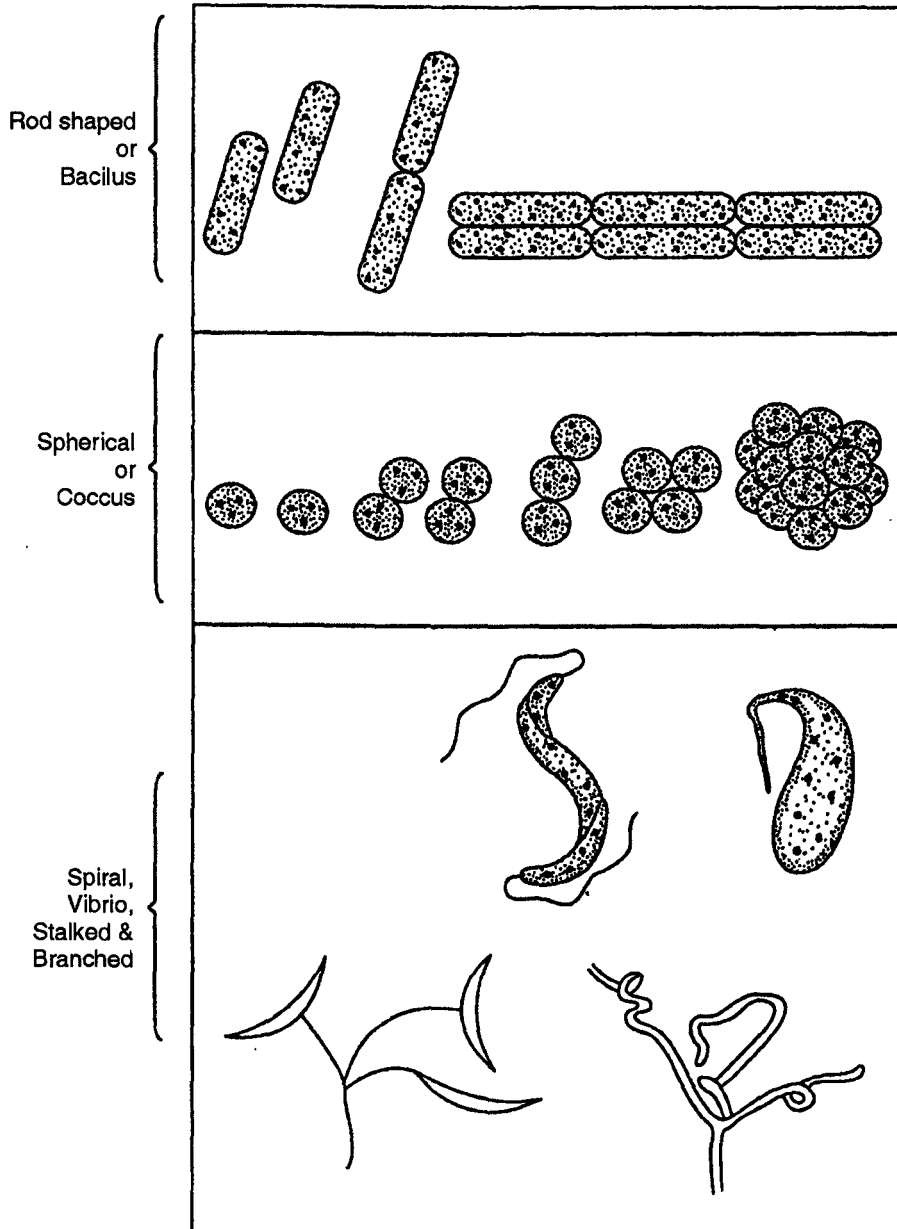

Fig. 1 : Different shapes of bacteria

(i) Structure external to cell wall.

- (a) Flagella (b) Pili (Fimbriae) (c) Capsules (d) Sheaths
- (e) Prosthecae and stalks (f) Cell wall

(ii) Structure internal to cell wall

- (a) Cytoplasmic membrane (b) Intracellular membrane system (c) Cytoplasm
(d) Cytoplasmic inclusions and vacuoles (e) Nuclear material

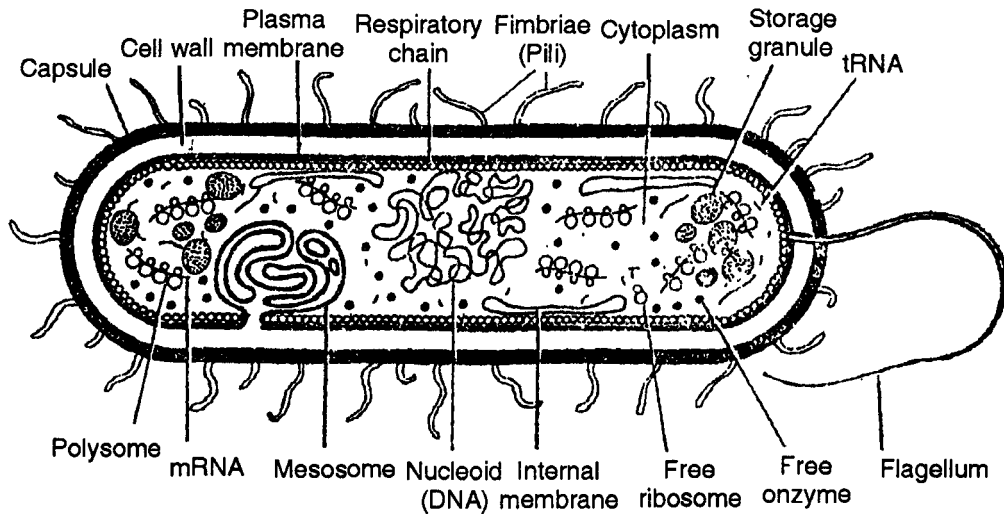

Fig. 2 : Generalized diagram of a bacterium

STRUCTURE EXTERNAL TO THE CELL WALL

(a) Flagella

Bacteria can be motile or non motile. The motile form swim by means of small flexible, whip like appendage called flagella (singular flagellum). They are much thinner than the flagella or cilia of eukaryotes. A typical bacterial flagellum measures about 120\AA thick and $4-5\ \mu$ long. Chemically they are made up of protein with a molecular weight of about 40,000. The protein of the filament is known as flagellin. These bacterial flagellum lacks $9 + 2$ arrangement (like eukaryotes)

The location of flagella varies in various bacteria. The bacteria which lack flagella are referred as atrichous e.g. *Diphtheria bacilli* and many cocci viz. *Lactobacillus* and *Pasturella*. The number and position of the attachments of the flagella on the bacterial wall vary according to the species. Therefore bacteria can be divided into following types :

(i) **Monotrichous:** Single flagellum at one end of the cell e.g. *Cholera vibrio* & *Pseudomonas citri*.

(ii) **Lophotrichous:** Two or more flagella at one end or both ends of the cell e.g. *Spirillum undula*.

(iii) **Amphitrichous:** One or many flagella at the end of the cell e.g. *Spirilla* and *Nitrosomonas*.

(iv) **Peritrichous:** Many flagella attached all round the cell e.g. *Salmonella* sp. and *Clostridium*.

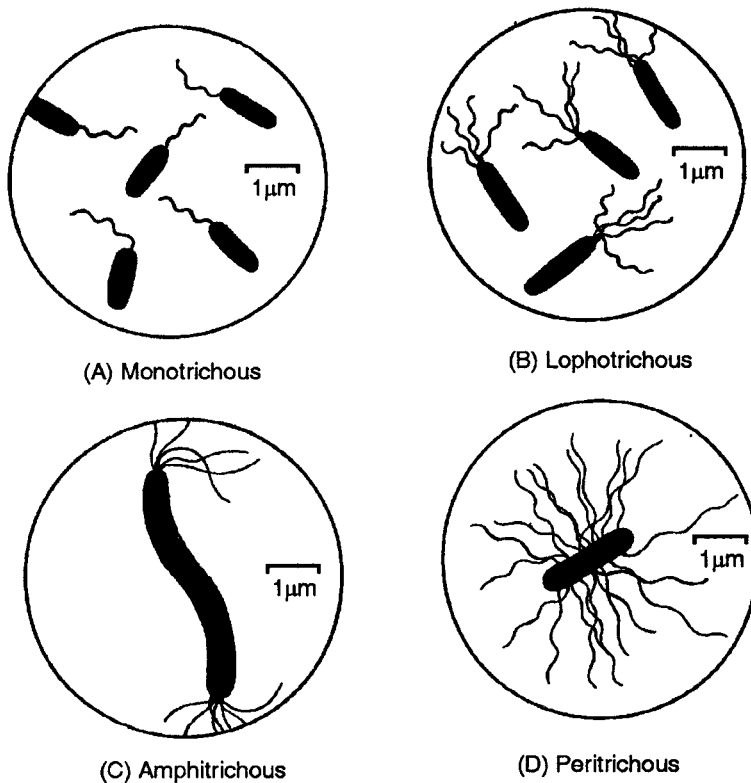

Fig. 3 : Various arrangement of bacterial flagella.

ULTRASTRUCTURE OF FLAGELLUM

Generally a single flagellum is ten times long as compared to their bacterial cell. There size is variable in different species but average size ranges from 4-10 μ in length and 120 A $^{\circ}$ - 180A $^{\circ}$ in diameter. These flagellum are generally made up of subunits of flagellin protein. The molecular weight of these subunit is 40,000 dalton and 40A $^{\circ}$ in diameter. This flagellin protein is synthesized inside the bacterial cytoplasm and are transferred to the terminal distal part of the flagellum, thus the growth of flagellum is from apical part inspite of its basal part. About 12 genes are found responsible for the synthesis of various parts of flagellum. Each bacterial flagellum is structurally differentiated into three parts (1) basal body (2) hook (3) main filament or shaft.

(1) Basal Body : It is a small rod like structure which is attached deep in the cytoplasm of the bacterial cell. This cytoplasm provide energy to this flagellum. In gram -ve bacterium it possesses two sets of rings (i) a proximal set (ii) a distal set. Each set consist of two pairs of rings. Outer pair is attached to the cell wall while inner pair is attached to the cell membrane. Thus total 4 rings are present and named as (i) Membrane (ii) Supermmembrane (iii) Peptidoglycan ring (iv) Lipopolysaccharide ring. They are arranged from inner side to outside. M ring is attached to plasma membrane

while P and L ring structurally form a bearing for the flagellar rod to pass through outer membrane. The flagellum of gram positive bacterium lacks the outer set of rings. The main function of basal body is (i) to synthesize the polymers of flagellum (ii) regulation of flagellar movement.

(ii) **Hook** : Hook connects the basal body and main filament or shaft. It originates from cell wall and the length of hook of gram negative bacterium is shorter than of gram positive bacterium. The main features of hook are:

- They provide specific shape to the flagellum.
- Each hook has specific antigenic property in each bacterium.

(3) **Filament or Shaft** : This is a tubular structure attached to the hook. It is 20 μ long 0.01-0.13 μ in diameter. It is made up of globular protein subunits. The amino acid involve in the synthesis of proteins are histidine, cystine and tryptophane. These protein subunits are arranged helically and form cylindrical fibrils. The protein is called flagellin. The bacterial flagellum is made up of single thin fibril while eukaryotic motile cells has a fibrill arranged in 9 + 2 pattern.

FUNCTIONS OF FLAGELLA

The main function of flagellum is to provide motility to the bacterial cell.

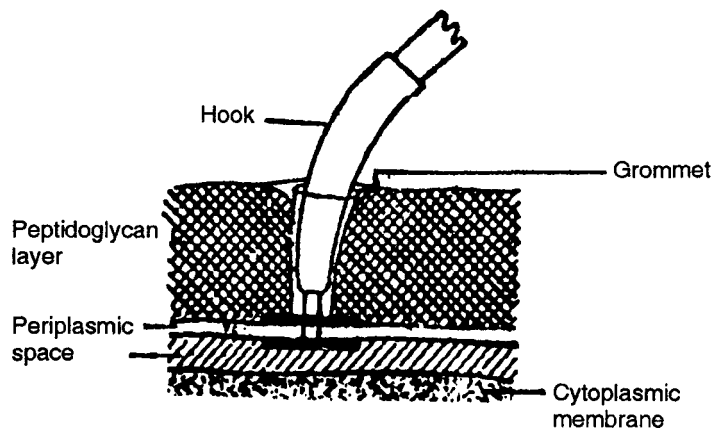

Fig. 4 : Structure of flagellum of a gram +ve bacterium

PILI OR FIMBRAE

These are hair like appendages present on the surface of most of the gram negative bacteria (Enterobacteriaceae, Pseudomonadaceae and Caulobacter). They are smaller than flagella, have no role in the motility of bacteria. They measure 0.2-20 μ in length and 30-140 \AA in width. A single bacterial cells bears about 100-500 pili which are arranged peritrichously. Their origin is from cytoplasm and penetrate through the peptidoglycan layers of the cell wall. Chemically they are composed of 100% protein named fimbriin with a molecular weight of about 16,000. Fimbriin consists of about 163 amino acids. Following two types of pili are found in bacteria viz.

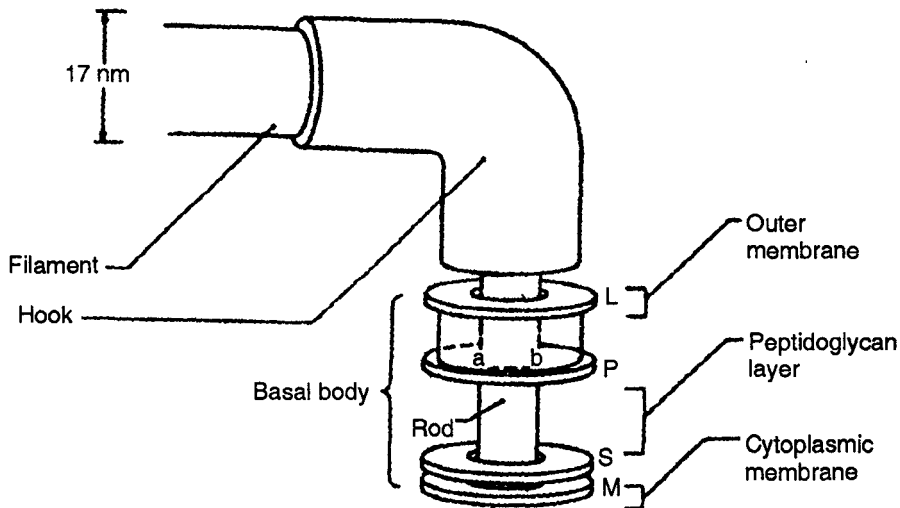

Fig. 5 : Structure of flagellum of gram -ve bacterium

(a) Somatic pili (b) Sex pili or conjugate pili

(a) **Somatic Pili** : Each bacterial cell bears about 100 somatic pili whose main function is to help the bacterium for attachment to a substratum.

(b) **Sex Pili or Conjugate Pili** : They are also known as F pili and are controlled by sex factors. These pili are comparatively long (20μ) and broad in width ($65-135 \text{A}^\circ$). Their number ranges from 1-10 in male or donor bacterium, but in some bacterium it is found in both viz. Male donor (+ factors) or female receptor/ receiver (- factor). At the time of conjugation the sex pili of male donor recognize the receptor protein on the surface of female or recipient and get attached with the help of conjugation tube. The DNA from the donor to recipient is transferred through this conjugation tube. There are two types of sex pili in *E.coli*. They are F. pili and I.pili.

In certain pathogenic bacteria these pili help the bacteria in the attachment of pathogenic bacterial cell to the host cells. There are generally four types of pili classified on the basis of their attachment ability to the host cell :

(a) **Type I** : Their diameter is about 90A° and found in *E.coli*, *Serratia* & *Salmonella*.

(b) **Type II** : They lack the attachment ability e.g. some species of *Salmonella*.

(c) **Type III** : Their attachment ability is effected by mannose sugar. They are about 50A° in diameter e.g. *Klebsiella* and some spp. of *Salmonella*.

(d) **Type IV** : They are found in *Proteus* bacteria.

Functions of Pili

(i) They help the bacteria to attach themselves to the natural substrate or to other organism due to its adhesive properties.

(ii) They bear antigenic properties.

- (iii) Sex pili are helpful in chromosome transfer during conjugation by acting as conjugation tube.
- (iv) They act as bacteriophage receptor.



Fig. 6 : F-pilus

Capsules

Some bacterial cells are surrounded by a viscous substance forming a covering layer or envelope around the cell wall called capsule. Electron microscopic study has revealed that capsule consist of a mesh or network of fine strands. This capsule only helps in disease causing ability of a few types of bacteria. This capsule is divided into two groups :

- (a) Macrocapsule: It is about $0.2\mu\text{m}$ thick and can be seen under light microscope.
- (b) Microcapsule: It can't be seen under light microscope but can be demonstrated immunologically.

Chemically the capsules are made up of di or polysaccharide or polypeptide. The polysaccharide may be homopolysaccharide (composed of single kind of sugar) e.g. *Streptococcus mutans* or it may be heteropolysaccharide (composed of several kind of sugars) e.g. *Klebsiella pneumoniae*.

Functions

- (i) They provide protection against temporary drying by binding water molecules.
- (ii) They may be antiphagocytic i.e. they inhibit the engulfment of pathogenic bacteria by W.B.C. and contribute to invasive ability.

Sheaths

Some species of bacteria of freshwater and marine environment form chains or trichomes which are enclosed by a hollow tube called sheath. Sheaths may be sometimes impregnated with ferric or manganese hydroxides which strengthen them.

Prosthecae and Stalks

These are semirigid extensions of cell wall and cytoplasmic membrane. They are characteristic of a number of aerobic bacteria from freshwater and marine environment. These prosthecae may be single (ex. *Caulobacter*) or several (*Ancalomicrobrium*)

The main function of prosthecae is that they increase the surface area of the cells for nutrient absorption in the dilute environment.

Stalk are non living ribbon like or tubular appendages that are excreted by the cell. These stalk aid in attachment of the cells to surfaces e.g. *Planctomyces*.

THE CELL WALL

Below these external structures viz. capsules, sheaths, flagella and above to the cytoplasmic membrane is the cell wall. This is a very rigid structure and provide definite shape to the cell. Since most of the bacteria lives in hypotonic environment, this cell wall prevent the cell from expanding and eventually bursting because of uptake of water. The cell wall is resistant to extremely high pressure. The cell wall constitutes a significant portion of the dry weight of the cell, it may account for as such 10-40% of the dry weight of bacterial cell. Bacterial cell walls are usually essential for the growth and division of bacteria.

Generally the cell wall is made up of large number of layers. The thickness of these different layers varies both in gram +ve and gram -ve bacteria. The walls of gram -ve species are generally thinner (10-15 nm) than those of gram +ve species (20-25 nm).

STRUCTURE AND CHEMICAL COMPOSITION

The most important constituent of the cell wall of eubacteria is peptidoglycan (sometimes called murein) which is an insoluble, porous, cross-linked polymer of enormous strength and rigidity. This peptidoglycan is only found in prokaryotes. It is basically a polymer of N-acetyl glucosamine (NAG), N acetylmuramic acid (NAM), and 4 amino acids (L-alanine, D-alanine, D-glutamate and a diamino acids).

The tetrapeptide of one peptidoglycan layer is cross linked with the other peptidoglycan layer and as a result a strong framework is formed around the cell and impart great rigidity to the total structure. Some antibiotics viz. penicillin inhibit the synthesis of this framework thus the cell wall synthesis is stopped.

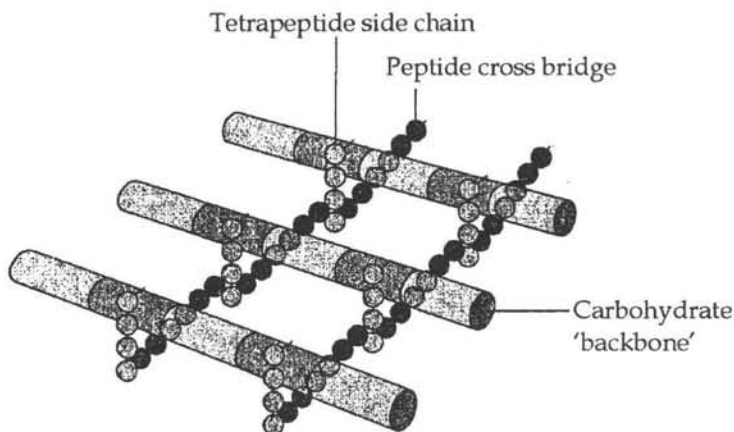

Fig. 7 : General structure of peptidoglycan

Walls of Gram +ve and Gram -ve Bacteria

Gram + ve bacteria have a much greater amount of peptidoglycan in their cell walls than do gram - ve bacteria. The cell wall of these bacteria consist of about 40-

80% of peptidoglycan of the dry weight of cell wall. This peptidoglycan is of about 40 or more layers in gram + ve bacteria. The cell wall measures about 30-80 nm in thickness. Teichoic acid or acidic polysaccharide are mainly present in gram positive bacteria and are found associated with peptidoglycan by a single terminal covalent bond. Teichoic acid is a negatively charged substituted polysaccharide polymer made up of ribitol and glycerol residues joined through diphosphoester linkages. It constitute a major

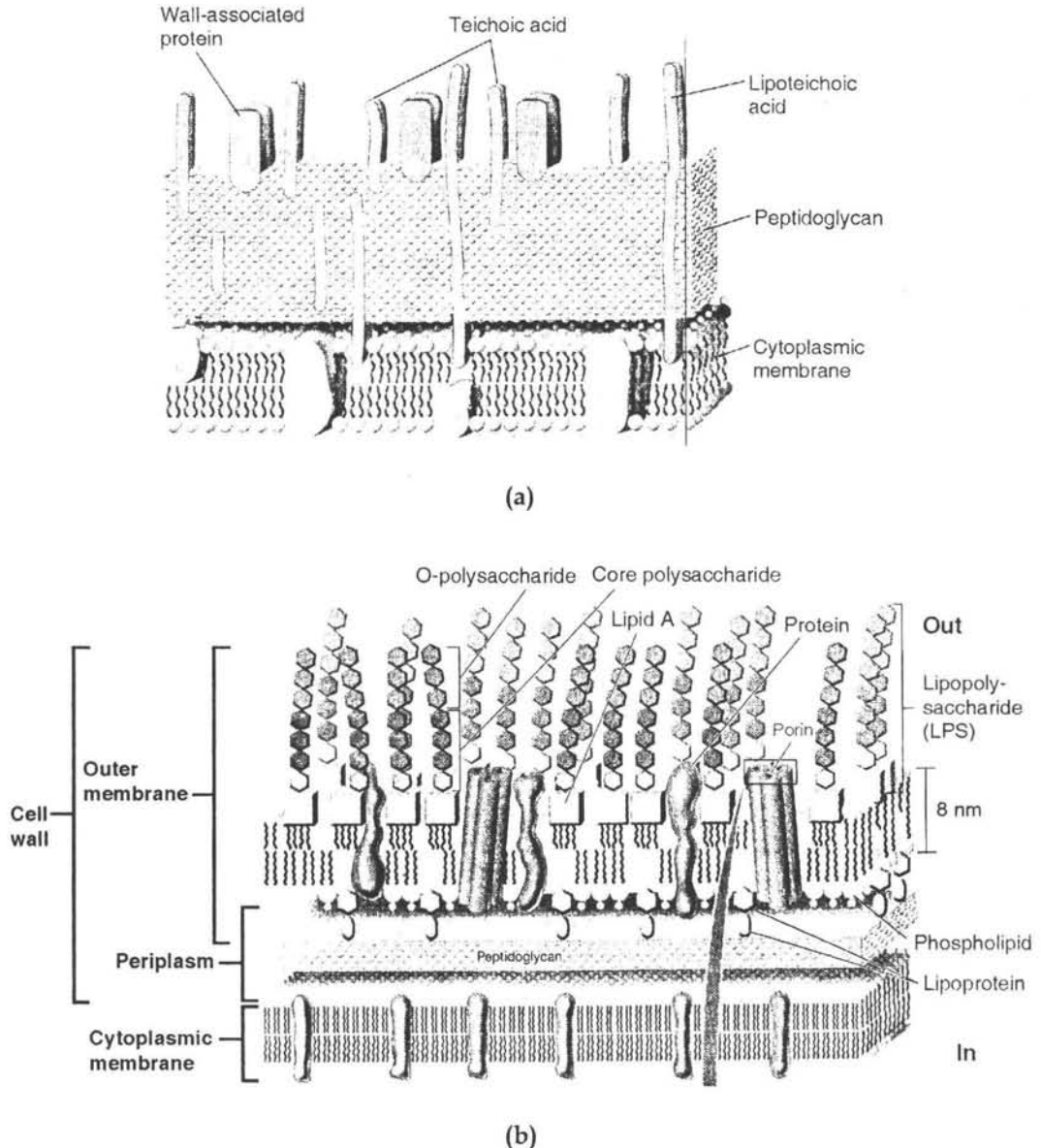

Fig. 8 : Cell walls of (a) gram +ve and (b) gram -ve bacteria

surface antigen. It is hydrophilic and its main function is to transport positively charged substances to the bacterial cell in the storage of phosphorous. Teichoic acid was discovered by Baddiley (1933).

Cell Wall of Gram Negative Bacteria

The wall of gram - ve bacteria are more complex than those of gram + ve bacteria. The envelop of this kind of bacteria is made up of two unit membranes and are separated by 100Å space known as periplasmic region and contains a peptidoglycan layer. The outermost membrane is known as cell wall while the inner one is referred as cytoplasmic membrane. Peptidoglycan is only about 5-10% of the dry weight of cell wall. The outer membrane serve as selective barrier for various external chemicals and enzymes that could damage the cells. Its structure is similar to plasma membrane or cell membrane. The outer membrane is anchored to the underlying peptidoglycan by means of Braun's lipoprotein. The membrane is bilayered structure consisting mainly of phospholipids protein and lipopolysaccharide (L.P.S.). The phospholipids are bilayered consisting of both hydrophilic and hydrophobic ends. The wall contains 4 types of protein components along with other major types of protein called lipoprotein.

The Lipopolysaccharide (LPS) has toxic properties and is also known as endotoxin. It occurs only in the outer layer of the membrane and is composed of three covalently linked parts :

- (i) Lipid A = firmly embedded in the membrane.
- (ii) Core polysaccharide = located at the membrane surface.
- (iii) O-antigens = which extend like whiskers from the membrane surface into the surrounding medium. Many antigenic properties of gram - ve bacteria are attributable to O-antigens.

The outer membrane is although impermeable to large molecules but can allow smaller molecules such as nucleosides, oligosaccharide, monosaccharides, peptides and amino acids. This is accomplished by means of channels in special proteins called porins.

Structure Internal to Cell Wall

Cytoplasmic Membrane : Immediate below the cell wall is cytoplasmic membrane which is similar in both gram + ve and gram -ve bacteria. It is about 75 nm thick bilayered membrane and is composed primarily of phospholipids (about 20-30%) and proteins (about 60-70%). The phospholipid form a bilayer in which most of the proteins are tenaciously held (integral proteins). These protein only can be removed by destruction of the membrane or by the treatment with detergents. Other proteins are loosely attached (peripheral proteins) and can be removed by mild treatment such as osmotic shock. Each phospholipids molecule of the bilayer has both hydrophilic head facing outwards and a hydrophobic tail facing towards each other. The lipid matrix of the membrane has fluidity. This type of structure of plasma membrane is known as fluid mosaic model.

The cytoplasmic membrane act as a hydrophobic barrier for the penetration of most

water soluble molecules. However specific proteins in the membrane facilitate the passage of small molecules (nutrients and waste products) across the membrane.

The cytoplasmic membrane also contains various enzymes involved in respiratory metabolism and in synthesis of capsular and cell wall components.

INTRACELLULAR MEMBRANE SYSTEM

Mesosome : Bacterial cell do not contain membrane bound organelles (Viz. mitochondria, chloroplast, golgi apparatus etc). But in bacteria the cytoplasmic membrane have specialized invaginations that can increase their surface area for certain function.

Especially in gram positive bacteria these membrane invaginations are in the form of convoluted tubules and vesicles termed mesomes. They are well developed in bacilli, and may be 2-4 in number in each cell. Their number is higher in those bacteria involved in higher respiratory activity e.g. *Azotobacter*. The mesosomes may be central or peripheral in position. The central mesosome penetrate deeply into the cytoplasm and located near the middle of the cell, and seemed to be attached to the genetic material of the cell and thought to be involved in replication of DNA and cell division. While the peripheral mesosome show only a shallow penetration into the cytoplasm seem to be involved in export of exocellular enzymes such as penicillinase.

The nature of mesosome was initially considered to be equivalent to mitochondria of higher plants and considered to be pockets of respiratory activity since they lack outer membrane they are not considered analogous to mitochondria. Along with this it is also devoid of many plasma membrane enzymes viz. ATPase, dehydrogenase, and cytochrome. It has been suggested that mesosomes help in the formation of septum.

Ribosomes : Ribosomes are found in free floating conditions and are randomly distributed in the cytoplasm. They constitute about 30% of the total weight of the bacterium (10,000 – 15000 ribosome in a bacterial cell). During protein synthesis a number of ribosomes are held together by mRNA and form polyribosomes. The number of ribosome is directly proportional to the rate of protein synthesis.

The ribosome of prokaryote are of 70s type whose molecular weight is about 2.7 million. Each 70s ribosome is composed of two subunits larger 50S and a smaller 30S. At low concentration of Mg^{+2} ions these 70S ribosome is dissociated into its two subunits.

Ribosome of *E. coli* bacteria is made up of 63% RNA and 37% protein or they are in 2:1 ratio. Many antibiotics like streptomycin and tetracycline who inhibit the protein synthesis in bacterial cell have a main target on the ribosome of the bacterium.

Lamellae or Chromatophore : Lamellar thylakoid or vesicles are found in many photosynthetic bacteria. They are known as chromatophores. Lamellae are synthesized by two unit membranes. These membranes are distributed throughout the cytoplasm. These chromatophore are hollow rounded structure with a diameter of about 300\AA . They bears photosynthetic pigments, enzyme required for light reaction, ETS system of photophosphorylation. They lack the enzyme required for dark reaction.

Cytoplasm : Cytoplasm is the part of bacterial cell surrounded by cell membrane. The 80% of cytoplasm is water, rest is nucleic acid, protein, lipids, carbohydrates inorganic ions and compounds of low molecular weight. The cytoplasm of prokaryote lack cytoplasmic streaming and cytoskeleton.

CYTOPLASMIC INCLUSIONS

Concentrated deposits of a variety of reserve materials are detectable in the cytoplasm of some bacteria. They have high molecular weight and usually Osmotically inert. They are mainly of three types :

(i) **Polymetaphosphate (PO_3^-)ⁿ :** They are also known as volutin granule or metachromatic granules which appear reddish violet after staining with methylene blue. They are most common in *Spirillum volutans*, *Corynebacterium diphtheriae* and *Mycobacteria*. This is required during nucleic acid synthesis.

(ii) **Poly β -Hydroxybutyrate :** They serve as source of metabolic energy and stained with sudan black. It is found in *Bacillus megatherium* who contain about 60% of the dry weight.

(iii) **Polyglucan Granules :** They appear blue, reddish blue or brown when stained with iodine.

(iv) **Sulphur inclusions :** They are found in bacteria growing in environment rich in sulphur e.g. purple sulphur bacteria which utilize H_2S either as e^- donor during photosynthesis or non-photosynthetic bacteria e.g. *Beggiatoa* and *Thiothrix*.

GAS VACUOLES

Some bacteria living in aquatic habitat form gas vacuoles that provide buoyancy. In light microscope these are bright, refractile bodies and can be made to collapse under pressure and there by lose their refraction. The wall is made up of protein eg. Non pigmented members of phototroph bacteria like *Polynema*, *Holobacterium* & *Clostridium*.

NUCLEAR MATERIAL

Like other prokaryote, bacteria lack a well defined nucleus. Its genetic material is designated under the area near the center of the cell and regarded as nucleoid/ chromatin body or bacterial chromosome since it consist of single circular DNA molecule in which all genes are linked. It can be made visible under the light microscope by Feulgen staining which is specific for DNA. Under Electron microscopy it appears as a light area with a delicate fibrillar structure. Its size measures, about 1000μ in length and 3 nm in diameter. Its molecular weight is nearly 5×10^9 . It has about 4000 genome whose replication is by semiconservative method. The bacterial chromosome differ from eukaryote chromosome in lacking histone (basic) protein however polyamines may be found to some of the phosphate group of the bacterial DNA. Polyamines are small molecules rich in amino groups.

The cross section of nucleoid show 500-900 strands folded back and forth several hundred times. The size of nucleoid increases during replication.

Plasmid and Episomes: In many bacteria in addition to nucleoid there is an extra small circular DNA segment which is in the form of ring is called Plasmid. Their replication is autonomous. This extrachromosomal DNA fragment was first discovered by Lederberg (1952). They are extrachromosomal, self replicating and stably inherited, whose size ranges from about 20-100 kb pairs (a bacterial chromosome is about 4000 kbp). Plasmid has an independent replication and contain own system for initiating and controlling the replication. The numbers of genes in plasmid vary from 3-4 who has no role in viability and growth of bacteria. Two types of plasmids have been identified:

1. **Conjugative Plasmid :** It carries genes that promote the transfer of plasmids from host cell to a recipient cell by conjugation.

2. **Non-conjugative Plasmid :** It can't promote its own transfer by conjugation.

Episomes are the plasmid which get integrated into the bacterial chromosomes. It was discovered by Jacob, Schaeffer and Wollman (1960)

The first mentioned plasmid responsible for fertility was named as fertility factor or F factor. It plays an important role in conjugation in *E. coli*. It is about 94.5 kb long carries the gene responsible for cell attachment and plasmid transfer between specific strains of bacteria during conjugation.

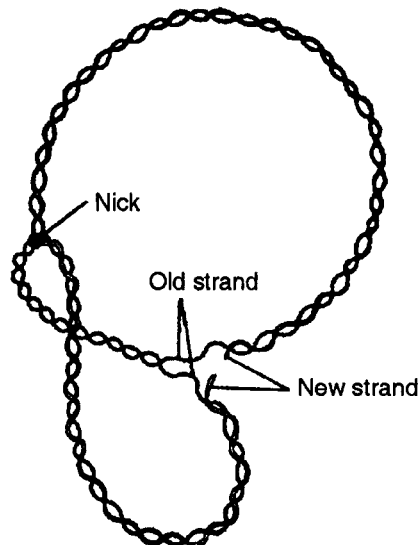

Fig. 9 : Bacterial Nucleoid

Important characteristic of naturally occurring plasmids :

1. They replicate independently of the main chromosome.
2. They are species specific to one or few species of bacteria.

3. They can undergo reversible integration into bacterial chromosome.
4. A few plasmid can pick up and transfer chromosomal gene.
5. They can be transferred by conjugation.
6. They usually contain upto 40 genes.
7. They do not occur free in nature.

NUTRITION

All form of life from microorganism to human beings share certain nutritional requirements for growth and normal functioning. Generally the bacteria are classified in two nutritional types on the basis of their nutrition requirement:

- (1) Autotrophic (2) Heterotrophic

(1) Autotrophic

A very small group of bacteria possess this type of nutrition. Few bacteria possess photosynthetic pigment bacteriochlorophyll other than normal chlorophyll found in higher plants are called photosynthetic bacteria. Thus autotrophic bacteria are of two types :

- (i) Photosynthetic bacteria (ii) Chemosynthetic bacteria

(I) Photosynthetic Bacteria

This type of bacteria possess a special type of pigment called bacteriochlorophyll. Along with this other pigment viz. Bacterioviridin or chlorobium chlorophyll is also found. These pigments are found on spiral structures called chromatophores. Like other higher green plants they synthesize carbohydrate by the fixation of atmospheric CO₂. Generally this fixation process occur in the presence of sulphur compounds which is mainly H₂S (hydrogen sulphide). Therefore it can be said that hydrogen sulphide is main hydrogen source in photosynthesis in bacteria and here sulphur is produced as byproduct in place of oxygen (produced in higher plants) in the chemical reaction.

The chemical reaction of photosynthesis is as follows :

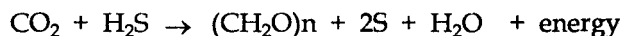

e.g. *Chromatium*, *Chlorobium* and *Chlorobacterium*

(II) Chemosynthetic Bacteria

Many bacteria uses the energy released from different type of chemical reactions for the conversion of carbon dioxide into carbohydrate (because they cannot utilize the photo energy due to lack of chlorophyll). Therefore they use the energy released from the oxidation of certain substances sulphur and its compound. Ammonia, Nitrites, Iron, Hydrogen, Carbon monoxide, methane are certain chemical substances whose oxidation is carried out by certain bacteria and the energy released is used by these bacteria for the synthesis of food. The important chemosynthetic bacteria are as follows :

(i) **Sulphur Bacteria** : The example of sulphur bacteria are *Thiobacillus*, *Beggiatoa* and *Thiothrix*. These bacteria utilizes the energy released by the oxidation of sulphur

and its compounds. For example *Thiothrix* oxidizes the hydrogen sulphide or mineral sulphides into sulphur. This sulphur get stored inside the bacteria and later get converted into sulphate.

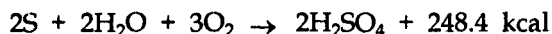

(ii) **Iron bacteria** : These bacteria generally oxidize the ferrous ion into ferric ion and releases energy. Eg - *Leptothrix*, *Ballionella* and *Ferrobacillus*.

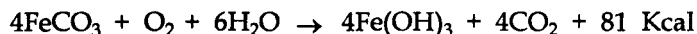

(iii) **Hydrogen bacteria** : These bacteria convert the molecular hydrogen into water utilize the energy released during chemical reaction. Eg - *Bacillus*, *Pantrotrophus*, *Hydromonas*.

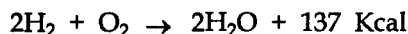

(iv) **Nitrifying bacteria** : These bacteria utilize the energy released from nitrogen compound. They are generally of two types (i) those who oxidize ammonia into Nitrous e.g. *Nitrosomonas* and *Nitrobacter* (ii) who convert nitrite into nitrate e.g. *Nitrococcus* and *Bactoderma*.

Along with this some chemo-organotroph bacteria are found who utilizes the carbon and its compound as a source of energy they are of following types :

(i) **Methane bacteria** : These bacteria convert and oxidize methane into carbon dioxide gas and water eg. *Methanococcus*, *Lactobacillus* and *Acetabacter*.

(ii) **Carbon bacteria** : These bacteria use the energy released by the oxidation of carbon monoxide e.g. *Bacillus oligocarbophilus*.

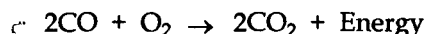

HETEROTROPHIC BACTERIA

Most of the bacterial species are hetrotrophic in nature i.e. utilize nutrition from other living being. Though they lack the photosynthetic pigment they are unable to utilize solar energy. These bacteria with the help of enzymes convert the complex organic compounds in soluble form and absorb them. These bacteria are classified into three types :

(a) Saprophytic (b) Symbiotic (c) Parasitic bacteria

(a) **Saprophytic Bacteria** : They survive on dead and deteriorating organic compound. These bacteria absorb nutrition from them. Firstly they convert the complex organic compound into soluble compound with the help of enzymes and then absorb them according to their requirement or absorb them conditionally. These bacteria are involved in the deteoration of dead bodies. They also undergo the process of putrifaction and fermentation of protein and carbohydrate respectively. They are generally facultative parasites or obligate saprophyte. In case of facultative parasite, they can utilize nutrition acting as parasite on living beings in case the dead organic matter is unavailable to them.

(b) Symbiotic bacteria : Those bacteria which grow and develop in close beneficial partnership or association with other living organism are called symbiotic bacteria and the phenomenon is termed as symbiosis. For example these, bacteria occur in the root nodules of leguminous plants where they fix free atmospheric nitrogen in the soil which is utilized by plants and plants in turn provide them carbohydrate and shelter for proper development eg. *Rhizobia* spp.

(c) Parasitic bacteria : Those bacteria which feed themselves on living tissues (host) are called parasitic bacteria. They are transmitted to the host by means of air, water and food. These bacteria may be obligate parasite or facultative parasite or may pathogenic or non pathogenic. These bacteria cause well known harmful diseases in plants and animals eg. Citrus Canker, Ring rot of potato in plants and tetanus, typhoid, tuberculosis and pneumonia in man.

REPRODUCTION IN BACTERIA

Bacteria generally reproduce very commonly by vegetative and asexual mode of reproduction. No sexual reproduction was reported by many microbiologist but electron microscopic study reports the unidirectional genetic recombination among certain bacteria.

Reproduction in bacteria includes the following methods :

(i) Vegetative reproduction

It includes the following types :

- (1) Binary fission
- (2) Budding
- (3) Cyst
- (4) Gonidia or segmentation

(1) Binary fission

The most common and most important mode of cell division which occur in bacteria when the environmental factor such as light, moisture, temperature are favourable is transverse binary fission. In this a single cell divides after developing a transverse septum (cross wall). Bacilli and spiral bacteria divide along the longitudinal axis of the cell while in coccus this division can be on any axis. Mesosomes play an important role in binary fission. Binary fission occurs in following steps:

(a) Division of nuclear or genetic material : When bacterial cell attains its maximum size, it generally increase longitudinally. After that its circular DNA undergo replication and results into two DNA components. This replication is of semi conservative type. Now these two DNA moves to two opposite poles with the help of mesosomes. Because no spindle fibres are formed during this entire process, this division is known as amitosis.

(b) Division of cytoplasm and septum formation : By the end of the division of nuclear material, the cytoplasmic membrane start invagination in the middle of the cell.

This invagination is of centripetal direction and the inner most layer of cell wall also invaginate along with the L_2 layer of plasma membrane and it forms the septum initial. This invagination appears as constriction on the cell surface. This constriction continuously deepens and results into two daughter cells. Under favourable conditions a single binary fission is completed within 18-20 minutes. But such a rapid rate of cell division cannot continue for a long time because the rapid increase in growth rate of bacterial population is inhibited due to following reasons :

1. Lack of space, food, water, oxygen other salts and accumulation of their own harmful waste products in the medium.
2. Environmental factors like light, temperature, moisture becomes unfavourable.
3. Death due to senescence and sometimes they are eaten by microscopic animals and viruses.

Therefore survival rate of bacteria in nature is only 1%.

(2) Budding

In this type of process the bacterial cell wall gets thinned at the end of cell, and it develops a cytoplasmic growth or protuberance which is covered by thin membrane. This structure is known as bud. It contain the part of genetic material of the parent cell. This out growth increases in size and develops a constriction at its base and ultimately it gets separated from parent cell. Now this bud cell increases in size and attain the size of parent cell eg. *Hypomicrobium*.

(3) Cyst

Cyst formation is very rare in bacteria eg. *Azotobacter*. Cyst is a spherical cell which is formed under unfavourable conditions. Here the entire protoplast of the bacterial cells rounds up, shortened, constricts and separated from the cell wall. After that a thick cell wall is formed around this entire structure. This structure is known as cyst and on germination it gives rise to a single vegetative cell.

(4) Gonidia or Segmentation

Bacteria which produces extensive filamentous growth form gonidia. Here such bacterial filament produces small bacillary or coccoid cells each of which give rise to new growth.

(ii) Asexual Reproduction:

It is of following types : Increase font size like Vegetative Reproduction.

- (1) By Conidia
- (2) By Oidiospores
- (3) By Sporangiospores
- (4) By Motile spores
- (5) By Endospores

(1) By Conidia

Many bacterial species viz *Streptomyces* produces small minute disc like rounded

bodies in chains at the tip of their filamentous structure. They are formed in chains. The filamentous bearing conidia is known as conidiophores. Conidia are formed in basipetal succession. Each conidium germinate and produce new filamentous bacterium.

(2) By Oidiospores

The entire filamentous structure of certain species of Actinomyces become septate at its end. Thus numerous micro size reproductive units are formed which are known as oidiospore. Each oidium on germination give rise to new filamentous bacteria.

(3) By Sporangiospores

Many branched filamentous bacteria become swollen at its terminal end and form sporangia. The cytoplasm of these sporangia divided to form small sized sporangiospore which on germination give rise to new filamentous bacteria under favourable condition.

(4) By Endospore

Endospore formation occurs in bacteria to tide over unfavourable environmental conditions. They are produced under conditions of limited supply of carbon, nitrogen and phosphorous. This process was first of all reported by Cohn (1817) and later by Koch (1877). Endospores are generally formed in bacteria pathogenic to plants, animals and human beings. Endospores are heat, chemical, drying, freezing and radiation resistant bodies. They can survive under dormancy even upto 50 years and on getting favourable environmental conditions they may germinate to start a new bacterial life.

Endospores are found in bacteria like *Bacillus*, *Clostridium*, *Sporolactobacillus*, *Sporosarcina* and *Desulfotomaculum*.

Generally a single cell transform into a single endospore but in certain cases two endospores are also reported from a single cell. They may be oval, ellipsoidal or spherical in shape and usually in central, terminal or sub-terminal in position.

Thus endospore is a highly resistant structure. The resistant nature is due to following reasons:

- (i) Lowest metabolic activities.
- (ii) Very few amount of water.
- (iii) Impermeable and protective nature of spore coat.
- (iv) Lack of active enzymes.
- (v) High percentage of Ca^{+2} ion in spore composition.
- (vi) Presence of stabilizer compound i.e. Picolenic acid.

The structure of endospore is variable in different species of bacteria. The cell wall is multi layered and acquire more than half of the volume of spore.

The bacterial protoplast core is mainly made up of DNA and is surrounded by dense cytoplasm. Protein percentage is about 90% of the total volume of the protoplasm. An acid dioccholnic acid act as stabilizer is found in cytoplasm. The amount of enzyme is very low in the spore.

The protoplast of spore is surrounded by a very thin membrane known as core membrane. Membrane in turn is surrounded by spore wall made up of disulphide rich protein called Keratin. The spore wall is about 30-60% of the dry weight of the spore. This spore wall provide protection to the spore from unfavourable conditions and harmful chemicals.

An electron dense cortex is present between the spore wall and inner membrane. This cortex is made up of modified peptides. The endospore of *Bacillus sphaericus* lack the cortex. While in some bacteria an extra membrane, exosporium is found. Spore wall is generally divided into outer and inner coat.

The developmental stage of endospore formation in *Bacillus subtilis* and *Clostridium* have been studied in detail and consist of stage O (Vegetative stage) to VII stage.

Under unfavourable condition when there is no cellular division and there is scarcity of ATP or energy in the cell, a special gene become active and is found responsible for the formation of endospore. In the presence of RNA polymerase enzyme this gene synthesize a special protein which initiate the formation of endospore in the cell.

Fitz-James & Young (1969) studied the process of formation of endospore in *Clostridium* Electron microscopically This can be divided into six main steps which are as follows :

(1) 0 Stage : In this stage the cell which is going to form endospore, enlarges in size and its chromatin material condenses attain the shape of an axial filament reaching from one end to the another end of the cell.

(2) I Stage : Axial filament develop completely. There is a change in the metabolic activity of the cell.

(3) II Stage: The plasma membrane start invaginating towards the one end of the cell. This invagination grows centripetally and both the end unite to form a spore septum. Septum formation ends by the formation of a small spore known as fore spore. The genetic material also get transported to this structure.

(4) III Stage : Spore septum of both i.e. mother cell and fore spore grows around the protoplasm of fore spore by a process called engulfment. Thus fore spore lies freely in the cytoplasm of mother cell.

(5) IV Stage : Cell wall of peptidoglycan is synthesized outside the plasma membrane of fore spore. This structure is called as spore wall.

(6) V Stage : There is a deposition of peptidoglycan cortex between the spore wall and cell membrane. The protoplasm condenses and synthesize dipiconilic acid whose deposition occurs on cell membrane. There is an increase in the concentration of Ca^{+2} , arginine and glutamic acid in the spore cytoplasm. Spore wall become multilayered.

(7) VI Stage : The spore mature into spore mother cell, the mother cell is called as sporangium.

(8) VII Stage : There is autolysis of sporangium and the spore is released free in the environment and it is transmitted by air.

The Endospore formation in *Clostridium* requires 2 hrs while *Bacillus subtilis* requires 7 hours. After transmission these endospores lie dormant for many years.

GERMINATION OF ENDOSPORE

The process of germination start under favourable environmental conditions. Spore coat becomes soft by the imbibition of water. The cytoplasm of spore swells up by absorbing salts, nutrients and water. Thus as a result the upper spore coat breaks up and the developing cell comes out. Generally a single spore is formed from a single bacterial cell and on germination of a single spore a single bacterial cell is formed. Thus endospore formation is considered to be the perennation method of bacterium.

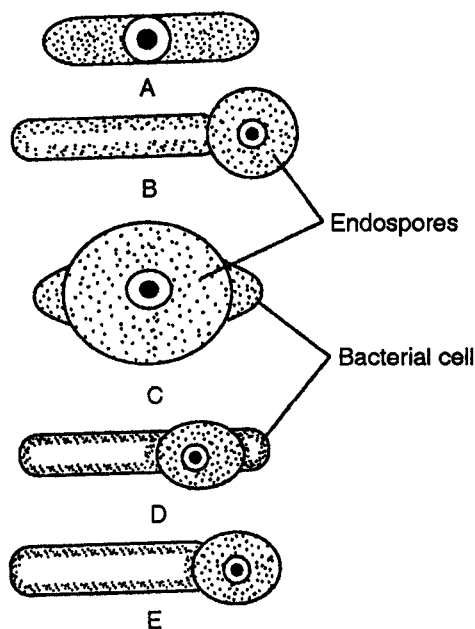

Fig. 10 : Structure of endospore

SEXUAL REPRODUCTION OR GENETIC RECOMBINATION

Unlike other prokaryote no true sexual reproduction is found in bacteria because (a) they lack sexual structures (b) no gametic fusion takes place. Karyogamy and meiosis is also absent in bacteria. Bacteria are haploid organisms. Gene transfer in bacterial cell donot produce zygotes but partial diploid called mero-zygotes. The original genome of recipient is named as endogenate. While the portion of DNA introduced from donar cell into recipient cell is called exogenome. However three different mechanism were later discovered for transferring gene or genetic material from one bacterial cell to another. These mechanisms in order of their discovery are :

- (i) Transformation

(ii) Conjugation

(iii) Transduction

(i) Transformation

It was first observed by Griffith (1928) who noted the transformation of harmless *Pneumococci* into virulent ones. Here there is transfer and expression of naked DNA from donor to recipient cell of bacteria takes place.

Transformation was discovered by Fredrick Griffith (1928) an English microbiologist while working on two strains of *Diplococcus pneumoniae* (new name *Streptococcus pneumoniae*). He reported that DNA is a genetic material.

Griffith used two strains of *D. pneumoniae* (i) bacteria with smooth and capsulated cell wall called as SIII (virulent or pathogenic)

(ii) Bacteria with rough and non capsulated cell wall called as RII avirulent or non pathogenic).

SIII is found responsible for causing death in mice while RII does not cause pneumonia in mice.

He carried out the following experiments on mice with these two strains. These are as follows :

- (i) No death of mice occur while injecting the RII bacterial strain in mice.
- (ii) Death of mice occur while injecting the SIII strain of bacteria.
- (iii) No death occur in mice while injecting it with the heat killed (heated at 85°C) SIII strain.
- (iv) Death of mice occurred while injecting it with a combination of heat killed SIII strain + live RII strain of *Diplococcus pnhenumoniae*. The virulent SIII and non virulent RII strains were isolated from killed mice. Thus it was concluded that by receiving the genetic material of heat killed virulent SIII strain, the living RII strains produces the progeny of virulent and pathogenic SIII strain. Although Griffith was unable to identify the transforming principle.

Based on the Griffith experiment O.T. Avery, Macleod and Maccarty performed further experiment *in vitro* system. They identified the transforming substance in 1944 as the polysaccharide present in the capsule of virulent strain SIII of *pneumococcus* which was absent in non virulent RII strain. Thus it was concluded that the DNA fragments isolated from dead mice get transformed into pathogenic and virulent SIII strain. This experiment explained that DNA is a genetic material.

For transformation the donor DNA must be single stranded and of specific size which transforms very easily in the RII strain of bacteria. During transformation the DNA fragment of SIII strain, bind and finally integrate in the bacterial chromosome of RII strain. The replaced portion of DNA of RII strain get destroyed.

Transformation is entirely a laboratory procedure and never occur in nature. It is found in various bacterial spp. viz *Bacillus*, *Haemophilus*, *Salmonella*, *Rhizobium* etc.

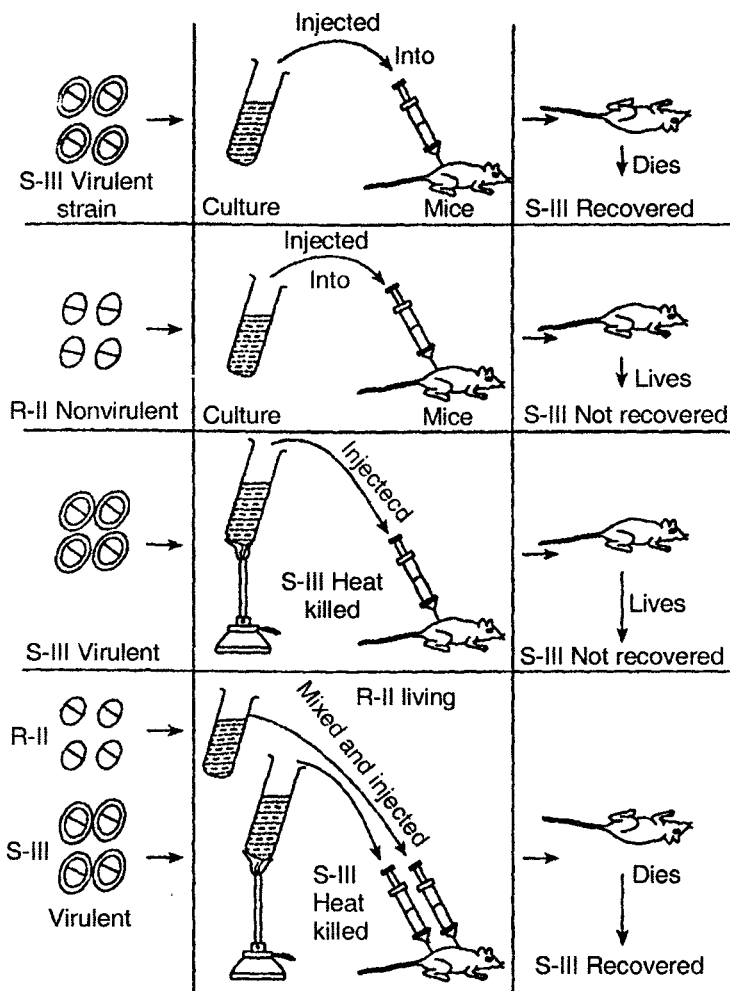

Fig. 11 : Griffith experiment

CONJUGATION

Conjugation is the commonest process of sexual reproduction in bacteria. In conjugation two parental cells physically contact between two genetically different cells of the same or closely related species and transfer their genetic material through a small tube like projection called conjugation tube. The genetic material from one cell (donor or male) is transferred to other (recipient or female).

Lederberg and Tatum (1946) used two mutant of the *E.coli* strain K12. Both mutant require certain growth factors while culturing on minimal media. These bacterial strain are known as Auxotrophs. Strains A of *E. coli* require methionine and biotin for their growth. Their genotype is $\text{Met}^- \text{Bio}^-$ while strain B require Threonine, Leucine and Thiamine for their growth. Their genotype is $\text{Thr}^-, \text{Leu}^-, \text{Thi}^-$.

The culture of both, strain A and strain B of *E. coli* were mixed and centrifuged and washed to remove the previous culture media. After that they were cultured in minimal medium. It was found that both the strains were able to grow in minimal medium or it was concluded that both strains (previously auxotrophs) get converted into prototrophs or it was confirmed from the above experiment that the conjugation recombination of both auxotrophic strain viz. Strain A ($\text{met}^- \text{bio}^-$) and strain B ($\text{Thi}^-, \text{Leu}^-, \text{Thr}^-$) resulted in the formation of prototrophic strain ($\text{Met}^+ \text{Bio}^+ \text{Thr}^+ \text{Leu}^+ \text{Thi}^+$). This experiment explain the genetic recombination by conjugation.

Fertility factor or F factor in conjugation was first of all discovered by William Hayes (1950) in *E. coli*. He reported that in *E. coli* a plasmid is present in the form of fertility factor. *E. coli* is classified in two strains on the basis of presence and absence of F factor. They are as follows :

- (i) F^+ strain bearing the fertility factor, also known as donor cell. It always bears sex pili or F pili on its surface.
- (ii) F^- strain lacking the fertility factor, also known as recipient cell. It lacks sex pili or F pili on its surface.
- (iii) According to Hayes in *E. coli* this sexual recombination is unidirectional where the genetic material is transferred to the recipient cell from the donor cell. This process occurs in following steps :
 - (a) In a group of bacterial cell the cells of two opposite strains viz. F^+ and F^- comes towards each other get attached by the sex pili. After that a tubular structure called as conjugation tube is formed.
 - (b) The DNA of bacterial plasmid is double stranded which become single stranded by the activity of enzyme endonuclease which create a nick as a result a 5' to 3' end of single stranded DNA becomes free.
 - (c) This single stranded DNA of the donor cell moves towards the recipient cell through the conjugation tube. The donor DNA moves by its 5' end into the recipient cell.
 - (d) The conjugation is completed after the transfer of single stranded DNA into the recipient cell. As a result both F^+ and F^- cells are separated.
 - (e) The single stranded plasmid DNA of donor cell combine with the recipient DNA strand with the help of enzyme ligase.
 - (f) The single stranded DNA of donor and recipient cell synthesize its complementary strand and becomes double stranded. Thus the recipient F^- strain change into F^+ donor strain.

HIGH FREQUENCY RECOMBINATION OR HFR TRANSFER

Jacob & Wollman (1951) reported, when F^+ plasmid of donor reaches to the F^- plasmid of recipient cell in the newly formed F^+ cell (previously F^- recipient cell) this plasmid occur in two stages (i) either it lie independently in the cytoplasm of F^+ cell (ii) or it get combined with the bacterial chromosome. This later stage where the F^+

factor combines with the bacterial chromosome is known as episome. The term episome was used by Lederberg *et al.* (1952). This type of bacterial cell convert into high, reproductive ability donor or male cell. This process is known as high frequency recombination or Hfr male. The reproductive ability of Hfr strain is 1000 times more than of F^+ strain. The integration of plasmid DNA with this genophore (F^- bacterial DNA) can occur in 20 parts.

Conjugation in Hfr male : During conjugation a conjugation tube is formed between the Hfr male and F^- recipient cell. After that the donor DNA opens near the F^+ factor and become single stranded. Now this single stranded DNA moves slowly from the donor cell to the recipient cell. This transfer process is continued until, both the Hfr and F^- cells are separated naturally. After this separation some part of DNA of Hfr strain remain inside the F^- recipient cell and get combined with the DNA of recipient cell as a result new genes are integrated into the recipient F^- cell. The combination of both the DNA results into the formation of a genetic hybrid which is partially diploid. This type of reproduction is found in *Salmonella*, *Pseudomonas*, *Vibrio* and *E. coli*.

Sexduction : Jacob Adelberg (1959) reported this process in bacteria. In general in Hfr strains the F^+ factor is integrated with the bacterial chromosome but some times this F^+ factor separate from the bacterial chromosomes and becomes fully autonomous and replicate independently.

Sometimes during separation this F^+ factor contains some genes of the bacterial chromosome and now it is called as F^+ prime. When this F^+ prime cells comes in contact with the F^- recipient cell it transfer some of the genes are taken from the DNA of the previous bacterial cell. This process is known as sexduction and as a result the recipient cell become partly diploid and the structure is called as merozygote.

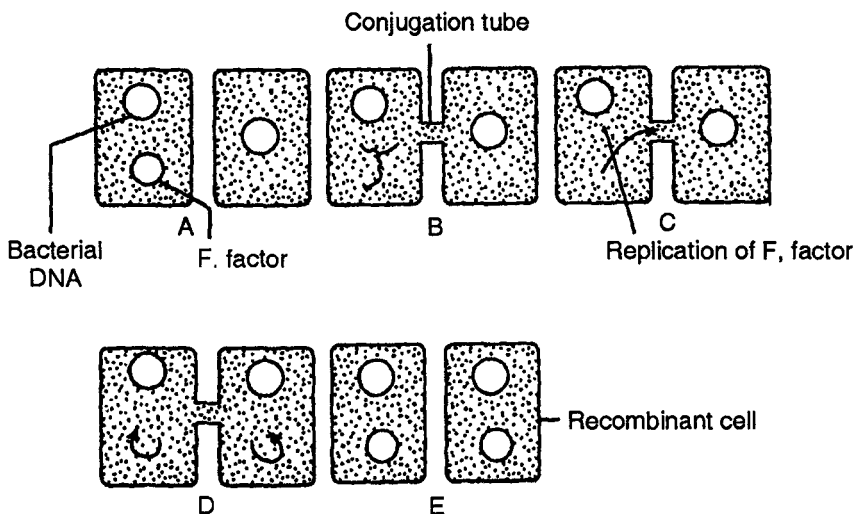

Fig. 12(a) : Conjugation in bacteria

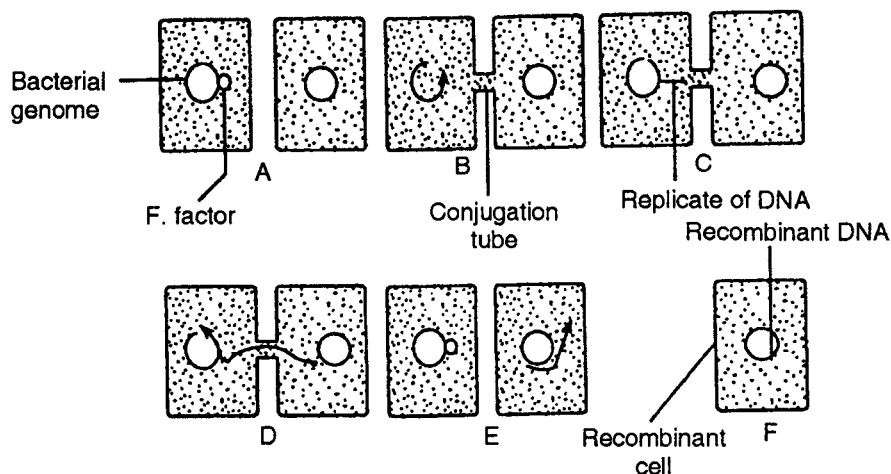

Fig. 12(b) : Conjugation in bacteria

TRANSDUCTION

This mode of gene exchange or reproduction was reported by Zinder and Lederberg (1952) in those forms of bacteria which are responsible for mouse typhoid (*Salmonella typhimurium*).

Transport of bacterial DNA of donor cell to the recipient cell with the help of bacteriophage or transduction is the bacteriophage mediated transfer of genetic material of donor bacterial cell to the recipient bacterial cell. Transduction has been reported in *E.coli*, *Proteus*, *Schizella* and *Staphylococcus*.

Zinder and Lederberg (1952) initially began their experiments with the objective of discovering whether the *E. coli* type of genetic exchange also existed in *S. typhimurium*. They cultivated two extotrophic strains of *S. typhimurium*. The strain A was unable to synthesize the amino acids, phenylalanine and tryptophan (Phe^- , Try^-) but could synthesize methionine and Histidine (Phe^- Try^- Met^+ His^+). The other strain was unable to synthesize methionine and histidine but able to synthesize phenylalanine and tryptophan (Phe^+ Try^+ Met^- His^-). Crossing or combine culturing of strain A and strain B resulted in a wild type prototroph which could synthesize all four amino acids. (Phe^+ Try^+ Met^+ His^+). Each auxotrophic strain, A and B was placed in both the arms of Davis U-tube. The two arms of tube were separated by a sintered glass filter which was impervious to bacterial cells but allowed the free passage of nutrient media and other molecules particles smaller than 0.1μ . The culture medium was made to pass through the filter from one arm to the other by alternating suction and pressure. Thus the two auxotrophic strain although physically separate were grown in the same medium.

A large number of prototroph appeared in the experiment. Thus it was concluded that these prototrophs are obtained by the method other than conjugation. Because this process was resistant to DNA enzyme activity, transformation process can't be involved in the synthesis of these prototroph. Thus the production of prototrophic *Salmonella* strain

is due to the activity of certain filterable agent which was later called as Bacteriophage P₂₂. The transducing frequency is low and our only one in 10⁵ to 10⁷ cells undergo transduction.

Hershey and Chase (1952) at the same time discovered bacteriophage and explained that during the infection of bacteria by bacteriophage there is a transfer of nucleic acid of bacteriophage into the bacterial cell.

Transduction is generally of two types:

1. Generalized transduction
2. Specialized transduction.

1. Generalized Transduction : It is completed in following steps:

- (1) This type of transduction starts with the infection of bacteria with the bacteriophage. This process is controlled by the DNA segments called as prophage particle present in the cytoplasm of bacterial cell.
- (2) During the infection of the lysogenic bacterial cell by bacteriophage, the DNA of the bacteria breaks down into small fragments and the nucleic acid of the bacteriophage utilizes the bacterial enzymes and synthesizes new phage components.
- (3) At the same time when these progeny phage particles are formed the DNA fragments of the bacteria incorporate into these DNA particles of the phage.
- (4) The genetic material or DNA fragments of the previous bacterial cell is transferred to the new bacterial cell infected by these progeny phage particles.

Thus generalized transduction is the process where bacteriophage plays an active role in the transfer of DNA fragments of the bacterial cell.

2. Specialized Transduction : Andre Lwoff *et al.* (1953) reported that certain bacterial strains are able to survive for a long time even after infected by the bacteriophage and there is no lysis of bacterial cell. Here in these bacteria there is a joining of bacterial DNA with the phage DNA and both DNA i.e. bacterial DNA and phage DNA replicate commonly. This bacteria is known as lysogenic bacteria and the phage is called as prophage.

This bacterial cells can survive in lysogenic stage for many generations which is due to the synthesis of a special repressor protein. This protein inhibits the synthesis of phage particle inside the bacterial cell. As the synthesis of this protein is stopped the bacterial cell starts the synthesis of phage components.

The DNA of both i.e. of phage DNA and bacterial DNA breaks down before the synthesis of the phage particles starts. At the same time some bacterial genes are carried out by phage DNA and replicate with the phage DNA. These resultant progeny phage particles are entirely different from the parent one when these progeny phage particles infect a new bacterial cell, some of the genes (of the previous bacterial cell) are also transmitted to the newly infected bacterial cell. In this type of transduction only those special genes are transmitted which are attached very closely to the phage DNA.

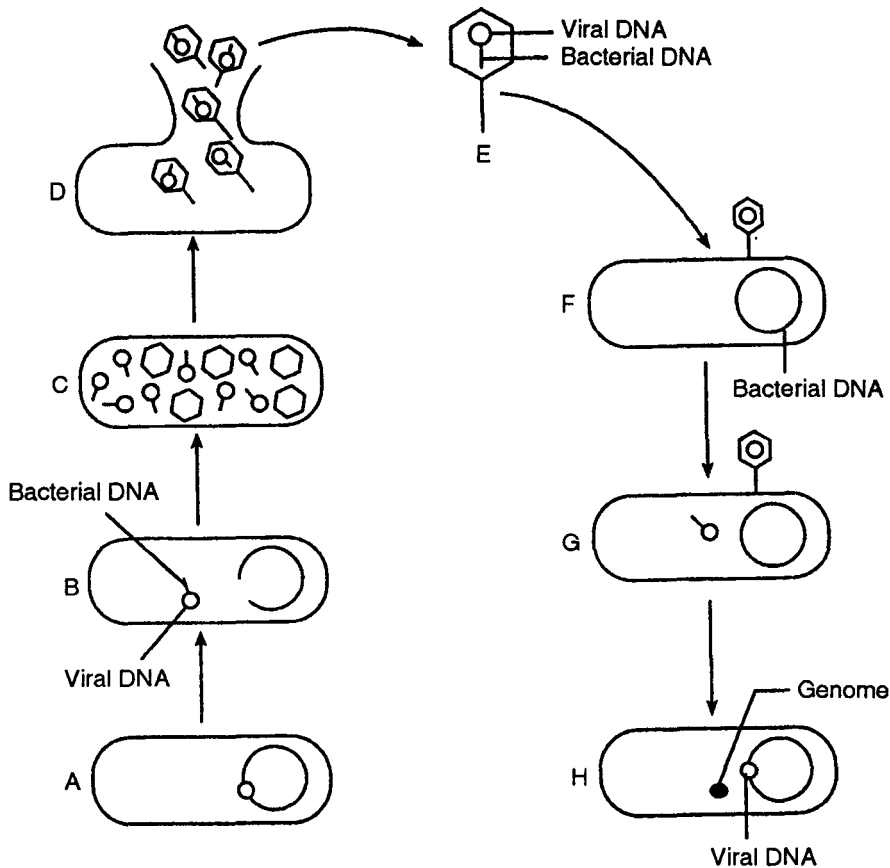

Fig. 13 : Transduction in bacteria

Gram Staining

One of the most important and widely used differential staining technique in microbiology is called Gram staining. This technique was introduced by Christian Gram (1884). In this process the fixed bacterial smear is subjected to the following staining reagents in the order, crystal violet, iodine solution, alcohol (decolorizing agent), and safranin. Bacteria stained by the gram method fall into two groups: Gram positive bacteria which retain the crystal violet and hence appear deep violet in color, and gram -ve bacteria which loses the crystal violet and counterstained by safranin and hence appear pink in colour.

The most plausible explanation for this phenomenon are associated with the structure and composition of the cell wall. The cell wall of gram negative bacteria is generally thinner than those of gram positive bacteria. Gram negative bacteria contain a higher percentage of lipid than do Gram positive bacteria. During staining of gram negative bacteria the alcohol treatment extracts the lipid which results in increased porosity or permeability of the cell wall. Thus the crystal violet -iodine (CV - I) complex

can be extracted and the gram negative organism is decolorised. These cells subsequently take on the color of the safranin counterstain. The cell wall of gram positive bacteria, because of their different composition (lower lipid content), become dehydrated during treatment with alcohol. The pore size decreases, permeability is reduced and the CV-I complex can't be extracted. There for these cells remain purple violet.

Another explanation is also based on permeability differences between the two groups of bacteria. In gram positive bacteria, the CV-I complex is trapped in the wall following the ethanol treatment which presumably causes a diminution in the diameter of the pores in the cell wall peptidoglycan. Walls of gram negative bacteria have a very much smaller amount of peptidoglycan, which is less extensively cross-linked than that in the walls of gram positive bacteria. The pores in the peptidoglycan of gram negative bacteria remain sufficiently large even after ethanol treatment to allow the CV-I complex to be extracted.

The two explanations, both contribute to the explanation of the mechanism of the gram stain. Furthermore if gram positive cells are treated with lysozyme (an enzyme) to remove the cell wall, the resulting structure called protoplast will be stained by the CV - I complex. However they are easily decolorized by alcohol. All these evidence points to the cell structure of gram positive bacteria as the site of retention of the primary stain.

(3) Many bacterial species are pathogenic to human beings, animals and plants. The parasitic bacteria pathogenic to human beings are as follows :

Disease	Bacteria
1. Cholera	<i>Vibrio cholerae</i>
2. Diphtheria	<i>Corynebacterium diphtheriae</i>
3. Pneumonia	<i>Streptococcus pneumoniae</i>
4. Tuberculosis	<i>Microbacterium tuberculosis</i>
5. Dysentery	<i>Schizella dysenteriae</i>
6. Typhoid	<i>Salmonella typhiae</i>
7. Anthrax	<i>Bacillus anthracis</i>
8. Tetanus	<i>Clostridium tetani</i>
9. Jaundice	<i>Leptospija ictero-hoemorrlugiae</i>
10. Meningitis	<i>Neisseria meningitides</i>
11. Plague	<i>Pasteurella pestis</i>
12. Leprosy	<i>Mycobacterium leprae</i>
13. Diarrhoea	<i>Bacillus coli</i>
14. Gastroenteritis	<i>Escherichia coli</i>

The parasitic bacteria destroys many economically important food crops. The disease produced by these bacteria in plants are as follows :

(i) **Wilt** : *Pseudomonas solanacearum* produces wilting in potato, brinjal and many cucurbits. Bacteria causes blocking of vessels in plants resulting in wilting.

(ii) **Rots** : *Erwinia, aroideae* causes rot disease in potato, raddish, tomato and cauliflower.

(iii) **Blights** : are caused by *Erwinia amylovera* in apple, pears who destroy the parenchymatous cells.

(iv) **Crown gall** : These are caused by *Agrobacterium tumifaciens* and causes hypertrophy in apple etc.

(v) **Citrus canker** : This is caused by *Xanthomonas citri* in lemon. It produces corky growth on the leaf and outer wall of the fruit.

(4) Many harmful bacteria are responsible for the reduction of soil fertility or denitrification. eg. *Bacillus denitrificans*, *Thiobacillus denitrificans* and *Micrococcus denitrificans* are very harmful to the agriculture because they convert the nitrate, nitrite, ammonia and other compounds in nitrogen into free atmospheric nitrogen. This results in reduction of fertility of soil. These bacteria are known as denitrifying bacteria. The percentage of these bacteria is very less in the soil.

(5) **Penicillin Destruction** : Some bacteria secrete an enzyme penicillinase which destroys the beneficial antibiotic penicillin.

(6) **Cotton destruction** : A bacterial species *Spirochaete cytophage* destroys the cotton fibres.

(7) **Water Pollution** : Many aquatic bacteria convert the mercury and its compounds into highly toxic methyl mercury from the affluent coming out from factories. This compound is highly toxic to the human beings and it is also neurotoxic in nature. Many pathogenic bacteria like *Vibrio cholariae*, *Schizella dysenteriae* and *Salmonella typhi* produces and causes many water born diseases in human beings like cholera, dysentery, typhoid.

□□□

7

VIRUSES

Viruses may be generalized to define as 'very small sized etiological agents of disease that are capable of passing through filters that retain even bacteria, increase only in the presence of living cells, and give rise to new strains by mutation'.

Mayer (1886) showed that the juice from the infected plants of tobacco could reproduce the disease if applied to healthy plants. The Russian botanist Dimitri Ivanowski (1892), demonstrated that the causal organism of tobacco mosaic could even pass through the finest porcelain filter that withholds bacteria. Ivanowski also showed that this filtrate was capable of transmitting the disease to healthy susceptible plants. He also indicated that these causal organism were even smaller than bacteria.

Beijerinck (1898) a Dutch microbiologist, showed that the causal agent of tobacco mosaic could diffuse through an agar membrane and was therefore liquid in nature such a liquid causal agent of tobacco mosaic was called by Beijerinck as "Contagium vivum fluidum" or 'living infection fluid'. Bacteriophages (viruses that parasitise bacteria) were discovered by the French scientist D. Herelle (1917) who found that some agent was destroying his cultures of bacilli.

Schelsinger (1933) was the first to determine the decomposition of virus. He showed that a bacteriophage consist of only protein and DNA.

Bowden (1964) defined viruses as 'submicroscopic, infective entities that multiply only intracellularly and are potentially pathogenic. According to Hahon (1964) viruses are 'bits of infectious heredity in search of a chromosome'.

Some define viruses as 'infectious nucleoproteins'. The word virus is derived from the latin language meaning 'poisonous liquid or 'poison'.

In 1935 Stanley crystallized the virus causing tobacco mosaic disease, and demonstrated that the crystals retained their infectivity when inoculated into healthy

plants Hershey and Chase (1952) studied the T₂ bacteriophage and demonstrated that (1) the genetic information is carried in the phage DNA and (2) that infection is the result of penetration of viral DNA into cells.

The nucleic acid fraction of the virus is the actual infectious agent was first shown by Gierrer and Schramm (1956). Phycophages were first isolated by Schafferman and Morris (1963) from blue green alga *Lyngbya*. The phage isolated by them was found to infect *Plectononema* and *Phormidium* also (hence named LPP-1), these are cyanophages.

Mycophages were first discovered in mushroom (*Agaricus bisporus*) by Sinden in 1957.

GENERAL CHARACTERS OF VIRUSES

- (1) They do not occur free in nature but act as obligate intracellular parasite.
- (2) They are extreme microscopic structure which can only be seen by electron microscope.
- (3) Mainly the size ranges from 100-2000 millimicron.
- (4) They can not be filtered by bacterial filters.
- (5) The genetic material is either DNA or RNA which occurs in the form of single molecule and can be single or double stranded.
- (6) A single virus particle is known as virion which lacks functional autonomy.
- (7) They lack their own enzyme system but interact with the host enzyme system and synthesize new virus particles. Thus they have a master and slave relationship.
- (8) Outer capsid of virus is proteinaceous and harmless and provide cellular specificity to the virus.
- (9) They are intracellular obligate parasite and can't be cultured on artificial culture media.
- (10) All animal and plant viruses have a narrow host range while others show a broad host range.
- (11) They show replication.
- (12) They are highly infectious and spread disease very quickly.
- (13) They show special kind of pathogenecity i.e. they cause disease at particular temperature. Most of virus become inert at 56-69°C (for 30 minutes)
- (14) They are haploid.
- (15) They are uneffected by antibiotics.
- (16) They show life between 5-9 pH.
- (17) They remain active for a long time when kept in 50% glycerol solution.
- (18) The extract of virus become inert at high pressure and high sound frequency.
- (19) They get precipitated with ethyl alcohol and acetone.

- (20) They can be inactivated by treatment with ultraviolet rays, pyridine, urea and hydrogen peroxide.
- (21) They can be crystallized.
- (22) They show response toward temperature, radiation and chemical substances.
- (23) They lack cell wall, nucleus, protoplasm and cell organelles.

How do Virus differ from Bacteria and Mycoplasmas?

Viruses differ from bacteria and mycoplasmas in :

- (i) not possessing any cellular organization.
- (ii) Not growing on inanimate media.
- (iii) not multiply by binary fission.
- (iv) Not possessing both DNA and RNA together.
- (v) Not possessing ribosome.
- (vi) Not showing any sensitivity to antibiotics.
- (vii) Showing sensitivity to interferon.

NATURE OF VIRUSES

The nature of viruses is still not clear, because it is not easy to define them within the accepted framework of living or non living organisms. Some virologist regard viruses as animate object (when present inside the host cell) whereas other consider them inanimate (when present outside the host cell).

Viruses are living because :

- (i) They show growth and multiplication (only inside the host cell).
- (ii) They have genetic material i.e. DNA/RNA.
- (iii) They can direct protein synthesis (though they use host machinery for it).
- (iv) They show mutation.
- (v) They can be transmitted from the diseased host to the healthy ones or possess the ability to infect.
- (vi) They react to heat, chemicals and radiation and also shows irritability, a character of only living organisms.
- (vii) They possess genetic continuity and have definite races/strains.
- (viii) Similarity between nucleoproteins of viruses with the protein and nucleic acid of living organisms.

Viruses are non-living because:

- (i) They can be crystallized (Stanley, 1935)
- (ii) They behave as inert chemicals outside the host cell.
- (iii) A cell wall or cell membrane of any type is absent in viruses.
- (iv) They do not show functional autonomy.

- (v) They do not respire or excrete or they do not show any sign of metabolism except reproduction.
- (vi) They lack any energy producing enzyme system.

Therefore the contention that 'viruses are viruses' (Lwoff *et al.*, 1966) and nothing else 'stands on the top'. According to regressive theory of evolution put forward by Lwoff, some primitive microorganism (like bacteria) become endoparasitic on some host and gradually lost synthetic enzymes to become today's viruses. Thus viruses are super parasites. It will thus be seen that viruses do not show all the characteristic of typical living organisms. They however possess two fundamental characteristic of living systems. Firstly they contain nucleic acid as their genetic material. The nucleic acid contains instruction for the structure and function of the virus. Secondly they can reproduce themselves, even if only by using the host cell's synthesis machinery. Because of such characters, some virologist consider viruses as a transition stage between living and non living world. They are living organism with some non living characters.

Occurrence

The occurrence of viruses in the cells of bacteria and higher plants and animals is well established.

Plant viruses: Most plant viruses have been found in angiosperm (flowering plants). Relatively few viruses are known in gymnosperm, ferns, fungi or algae. Plant viruses are of great economic importance, since they cause plant diseases in a variety of crops.

Animal viruses: Virus diseases are known in a variety of vertebrates including fish, amphibian, birds and mammals. Important virus diseases of humans include poliomyelitis, small pox, rabies, mumps, measles, yellow fever, influenza and encephalitis.

Bacteriophages: Viruses have been found in practically all groups of bacteria. The host range is confined within bacterial groups. A bacteriophage may multiply only in certain strains of *E.coli*.

VIRUSES IN EUKARYOTIC MICROORGANISM

Virus like particles have been observed in species of Protozoa, algae and fungi.

Protozoa: Viruses or virus like particles have been observed in several protozoa viz., *Leishmania*, *Entamoeba histolytica*, *Plasmodium vivax*, *P. berghei*, *Paramecium aurelia*, *Carchesium polypinum* and *Acanthamoeba* sp. A virus like particle has been reported in *Plasmodium berghei*. Its structure is like that of a cytoplasmic Polyhedrosis virus, a dsRNA virus of insects.

Algae: Virus like particles have been reported in *Aulacomonas submarina*, *Chara*, *Corralina*, *Oedogonium* spp., *Uronema gigas*. Bacteriophage like virus particles have been found in *Chlorella* and have been called chlorellophages.

Fungi: Killer phenotypes associated with the strains of *Saccharomyces cerevisiae* and *Ustilago maydis* have been shown to be virus related. dsDNA viruses have been detected in cells of *Penicillium* moulds. dsRNA viruses are widely present in the higher

fungi. The bacilli form particles of *Agaricus bisporous* is the only fungal virus reported that contains ssRNA.

DEFINITION

Virion: A single infective particle of virus is called as virion. It consists of nucleic acid core surrounded by a protein coat or capsid. The capsid with enclosed nucleic acid is called nucleocapsid.

Viroids: These are the smallest infectious agents causing diseases in host. They consist solely of a protein free low molecular weight (75,000 - 1,25,000 dalton) with 243-360 nucleotides and small fragments of double stranded RNA molecules. They are also known as naked virus, meta virus or pathogene.

Evidence shows that viroids replicate by direct RNA copying in which all components required for viroid replication including RNA polymerase are provided by the host. During viroid replication, the circular (+) strand of the viroid is replicated while it acts as a rolling drum producing multimeric linear strands of (-) RNA. The linear (-) strand then serves as a template for replication of multimeric strand (+) of RNA. The (+) RNA is subsequently processed (cleaved) by enzymes that release linear, unit length viroid (+) RNA's which circularize and produce many copies of the original viroid RNA.

Viroids apparently interfere with the host metabolism in ways resembling those of viruses but of what way is still unclear. It has been shown that both virus specific RNA's synthesized during infection and viroid RNA *in vitro* activate a protein kinase enzyme, which in turn activates other cellular enzymes while it impedes the initiation of protein synthesis. As viroid strain that cause mild to severe plant symptoms activate the protein kinase more than 10 times as much as mild strains, it is possible that activation of the protein kinase represents the triggering event in viroid pathogenesis and in disease development by the plant.

Viroids are spreaded from diseased to healthy plants primarily by mechanical means, i.e. sap carried through hands or tools during cultural practices while some are transmitted by pollen and seed.

Viroids survive in nature outside the host or in dead plant matter for periods of time from few minutes to few months. They are quite resistant to high temperature and can't be inactivated in infected plant by Heat treatment.

The control of diseases caused by viroids is based on the use of viroid-free propagating stock, removal and destruction of viroid infected plants and washing of hands or sterilizing of tools after handling viroid infected plants before moving on to healthy plants.

Potato spindle tuber viroid (PSTvd) is the first recognized viroid, which consist of 359 nucleotides under E.M. Purified PSTvd appears as short strands about 40 nm long and has the thickness of a dsDNA.

Viroids seem to be associated with cell nuclei particularly the chromatin and possibly with the endomembrane system of the cell.

It was first discovered by Diener (1971) as the causal agent of potato spindle tuber disease. Other viroid caused disease reported so far are- tomato bunchy top disease,

chrysanthemum stunt disease, coconut cadang disease, tomato apical stunt disease, Avocado sunblotch etc.

They undergo replication by using the host enzyme system. Their transmission is through the chromatin material of host cell.

Virusoides: It has been introduced by Rendle *et al* (1981). "Virusoides are the viroides which require RNA of the supportive virus for replication".

At present it has been reported only in Australia with few examples of its host. viz. one virusoid is reported along with velvet tobacco mosaic virus. Other virusoides are attached as satellite along with other virus RNA.

These virusoides undergo replication with the help of RNA of the helper virus inside the host cell.

Prions: Haig and Claske (1966) discovered a subviral infectious agent which was later called as prions by Prusiner *et al*. Later Prof. Prusiner has been awarded nobel Prize (1997) for medicine for the discovery of prions.

These prions are the causal agent of scrapie disease (a degenerative disorder of central nervous system) of sheep and goat. These prions have no nucleic acid (DNA/RNA) but they are made up of only 2-3 molecules of protein only.

Prions are 100 times shorter than viruses and are heterogenous in nature. A single prion rod is made up of about 1000 prion molecules. It is 100-200 nm long and 10-20 nm in diameter. Other disease caused by prions are Parkinson's disease, multiple sclerosis, Gerstmann Stransslar syndrome and Creutzfeldt-Jakob disease.

SIZE AND STRUCTURE OF VIRUSES

The size of viruses is variable. Most viruses are much smaller than bacteria. Their size ranges from 10 nm - 250 nm. The size of viruses is determined by electron microscopy, ultra centrifugation and by filtration through colloidion membrane of known pore diameter.

The smallest virus is coliphage F₂ measuring about 2 nm.

The smallest plant virus is satellite tobacco necrosis virus measuring 17nm.

The longest known plant virus is citrus tristeza virus-rod shaped measuring 2000 x 12 nm.

Foot and mouth virus of cattle is the smallest animal virus measuring about 10 nm.

Pox viruses are the largest and most complex animal viruses.

Parrot fever virus measuring 400 nm.

Structure of Viruses

The intact virus unit or infectious particle is called the virion. Each virion consists of a nucleic acid core surrounded by a protein coat (capsid) to form the nucleocapsid. The nucleocapsid may be naked or may be surrounded by a loose membranous envelope. It is composed of a number of subunits called capsomeres. The capsid protects the nucleic acid core against the action of nucleases. Structurally viruses occur in three main shapes viz. spherical or polyhedral, cylindrical or helical and the complex type.

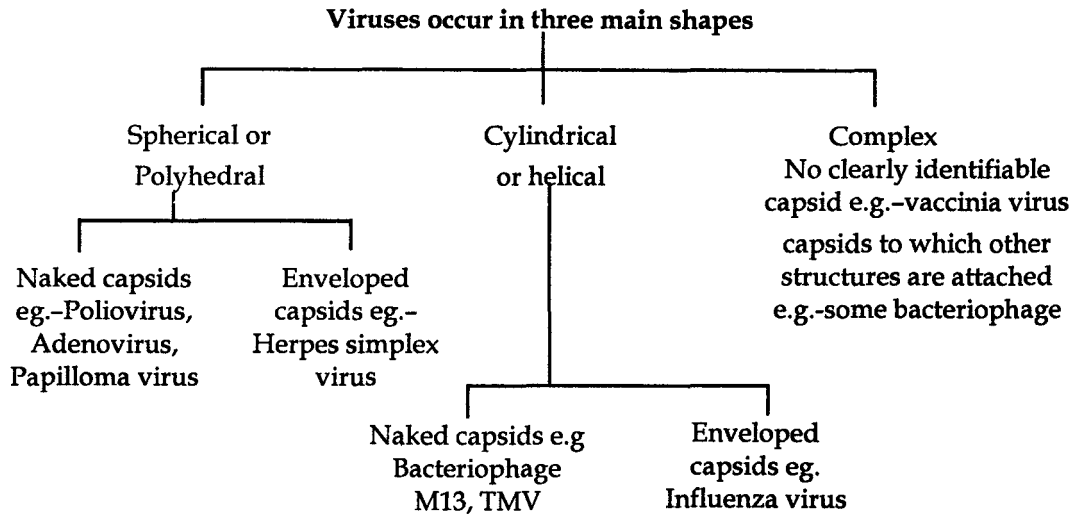

(I) POLYHEDRAL (ICOSAHEDRAL) SYMMETRY

Crick & Watson have shown that the polyhedral capsids can have three possible types of symmetry viz. Tetrahedral, octahedral and icosahedral.

Icosahedral is the most efficient shape for the packing and bonding of subunits of a near spherical virus. In icosahedral symmetry a large number of intermolecular bonds can be formed in this type of structure and is therefore has low free energy. An icosahedron is a regular polyhedron with 20 faces formed by equilateral triangles and 12 intersecting points or corners.

Each capsid consist of many capsomeres. Each capsomere is composed of a few monomers which form polygonal rings, each with a central space of up to 40 Å°. The monomers are the structural units and are made up of one or more polypeptide chains.

There are two types of capsomeres :

- (i) Pentamers or pentagonal capsomere is made up of 5 monomers.
- (ii) Hexamers or hexagonal capsomere consist of 6 monomers.

TABLE 1

No. of Capsomeres	Example
12	$\phi \times 174$
32	Turnip yellow mosaic virus & poliovirus
72	Polyoma virus, Papilloma virus
92	Reovirus
162	Herpes virus
252	Adenovirus
812	Tipula iridescent virus

The monomers are held together by bonds, each monomers having bonds with two neighbouring monomers. The capsomeres are also held together by bonds. These bonds are weaker than the bonds between the monomers.

The minimum number of capsomeres can theoretically be 12 followed by 32, 72, 92, 162.....of these capsomeres 12 are pentamers occupying the 12 corners, while the rest are hexamers.

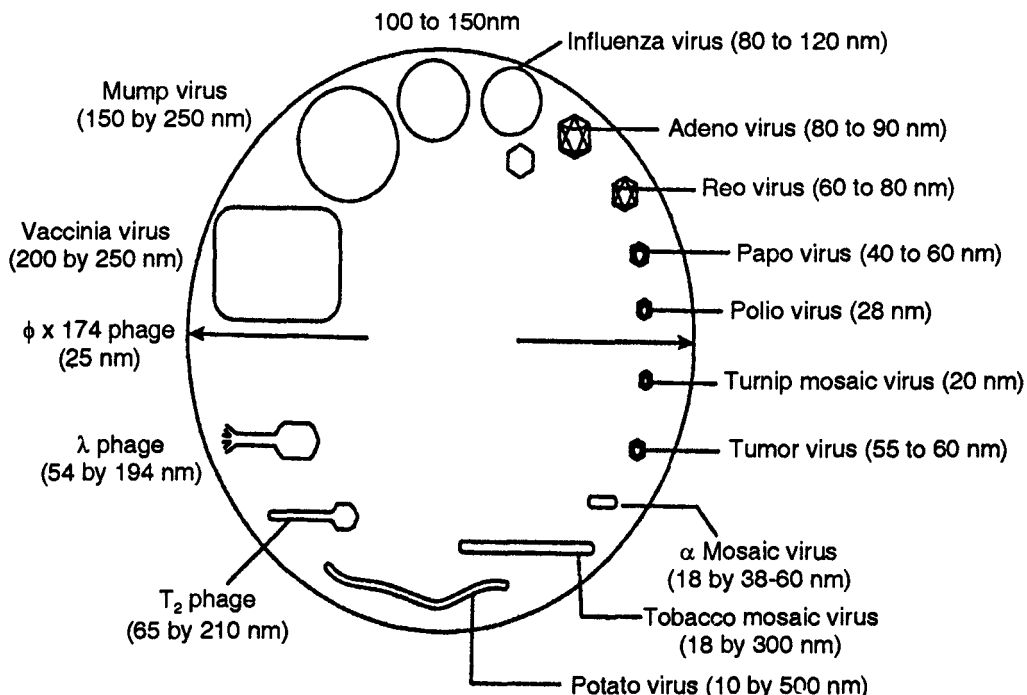

Fig. 1 : Size and shape of various viruses

(II) HELICAL SYMMETRY

The helical capsid consist of monomers arranged in a helix around a single rotational axis. The monomers curve into a helix because they are thicker at one end than the other. Helical capsids may be naked (e.g. the tobacco mosaic virus) or surrounded by an envelope (e.g. influenza virus).

Tobacco Mosaic Virus

Virus is rod shaped about 300 nm x 15-18 nm in diameter. X-ray diffraction studies have shown that the virus consists of a protein tube with a lumen of 20 Å enclosing a single strand of helically coiled RNA. The tube is made up of a number of identical sub units (monomers) of proteins arranged in a helical manner. Studies by Franklin and her co-workers have shown that there are 49 subunits of protein for three turns of the helix, thus giving a total of 2,130 subunits for the rod. Each subunit has a molecular weight of 17, 500 and consist of single poly chain made up of 158 amino acids.

The RNA is a single stranded molecular coiled into a helix 80\AA in diameter. It follows the pitch of the protein helix. Each turn of RNA helix contains about 49 nucleotides with a pitch of 23° .

(III) COMPLEX SYMMETRY

Complex viruses are divided into two groups:

- (a) Those without identifiable capsids.
- (b) Those with capsids to which are attached additional structures.

Vaccinia virus is an example of a virus without a definite capsid. The nucleic acid is surrounded by several coats.

Bacteriophages are the virus that infect bacteria, was discovered independently by Frederick Twort in England 1915 and by Felix d' Herelle at the Pasteur Institute in Paris in 1917. D'Herelle noted that something was dissolving or lysing their bacterial cultures of Staphylococci and this lytic effect could be transmitted from colony to colony. Even high dilution of material from a lysed colony that had been passed through a bacterial filter could transmit the lytic effect. However heating the filtrate destroyed its lytic properties. And this lytic phenomenon is commonly called as Twort-d'Herelle phenomenon.

In nature 'Phages' occur commonly in close association with bacteria. They play an important role in the transmission of genetic information between bacteria by transduction process. Bacteriophages provide the only convenient model to study the virus-host interaction at cellular and molecular levels.

All most every group of bacteria is attacked by one or other phage. But *E.coli* has been studied most extensively from this point of view. Bacteriophage attacking *E.coli* are called coliphages and are designated T type. These were numbered $T_1, T_2, T_3, \dots, T_{17}$ by Max Delbruck (1938). The best known and most thoroughly studied are T_2, T_4, T_6 which are collectively called T-even phages. T_3, T_5 are called T-odd phages.

There are two main types of bacterial viruses, lytic or virulent and temperate or avirulent. When lytic phages infect cells, the cells respond by producing large number of new viruses. That is at the end of the incubation period the host cell bursts or lyses, releasing new phages to infect other host cells. This is called a lytic cycle. In the temperate type of infection, the result is not so readily apparent. The viral nucleic acid is carried and replicated in the host bacterial cells from one generation to another without any cell lysis.

Bacterial viruses may be grouped into six morphological types:

- A = This is most complex type has a hexagonal head, a rigid tail with a contractile sheath and tail fibers. e.g. T_2, T_4, T_6 (T-even).
- B = Similar to A, this type has a hexagonal head. However it lacks a contractile sheath, its tail is flexible and it may or may not have tail fibers. eg. Coliphages like T_1 and T_5 .
- C = This type is characterized by a hexagonal head and a tail shorter than the head. The tail has no contractile sheath and may or may not have tail fibers. eg. Coliphage T_3 and T_7 .

D = This type has a head made up of large capsomeres, but has no tail eg. Coliphages, ϕ x 174, S₁₃.

E = This type of head made up of small capsomeres but has no tail eg. Coliphages F₂, MS₂.

F = This type is filamentous. eg. Coliphages Fd, Fl.

G = Pleomorphic, no detectable capsid, envelope contain lipid eg. MV- L2.

Type A,B,C show morphology unique to bacteriophages. The morphological types in groups D and E are found in plant and animal (including insect) virus. The filamentous form of group F is found in some plant viruses.

Bacteriophages of the T-even Series (T₂, T₄, T₆)

It is an example of complex viruses with capsids and attached structures. T₄ bacteriophage is tadpole shaped, with head and tail regions. Head capsid is 95 x 65 nm and has the form of a prolate icosahedron. It is made up of about 2,000 similar subunits and is packed with circular double stranded DNA (500 nm long). Head capsid consist of two 10-faceted equatorial bands with a pyramidal vertex at either end. The tail has helical symmetry. Thus the bacteriophage shows a combination of icosahedral symmetry and helical symmetry (binal symmetry).

The tail consist of a core tube 80A⁰ in diameter, through which DNA passes out surrounded by a protein tail sheath. The sheath consists of 144 subunits arranged in 24 rings of 6 subunits each. The sheath is connected to a thin disc, called the collar at the upper end and a base plate at the lower end. The base plate is hexagonal and has a pen or spike at each corner. From each of the six corners is also given off a long, thin tail fibre. 1300A⁰ long, which serves for the attachment of the bacteriophage to the host cell.

CHEMICAL COMPOSITION

The intact virus unit or infectious particle is called the virion. Each virion consist of a nucleic acid core surrounded by a protein coat (capsid) to form the nucleocapsid. Some icosahedral and helical animal viruses, plant viruses and bacteriophage are surrounded by a membranous envelope 100-150 A⁰ thick.

The envelop resembles the typical biological membrane in consisting of a phospholipids bilayer in which are embedded proteins. It has spikes which are composed of glycoproteins. Viral envelop contain host cell protein as well as protein specified by the virus. Carbohydrate in enveloped virus are only found as glycoproteins but also as glycolipids. Lipid in virus envelop are derived from the host cell. This is shown by the fact that (i) virus rarely have lipids not found in host cells. (ii) when viruses are grown in different host cells they show differences in their lipid pattern (iii) Radioactively labelled cellular lipids are incorporated intavirions. The different lipid are phospholipid, cholesterol, fatty acid etc.

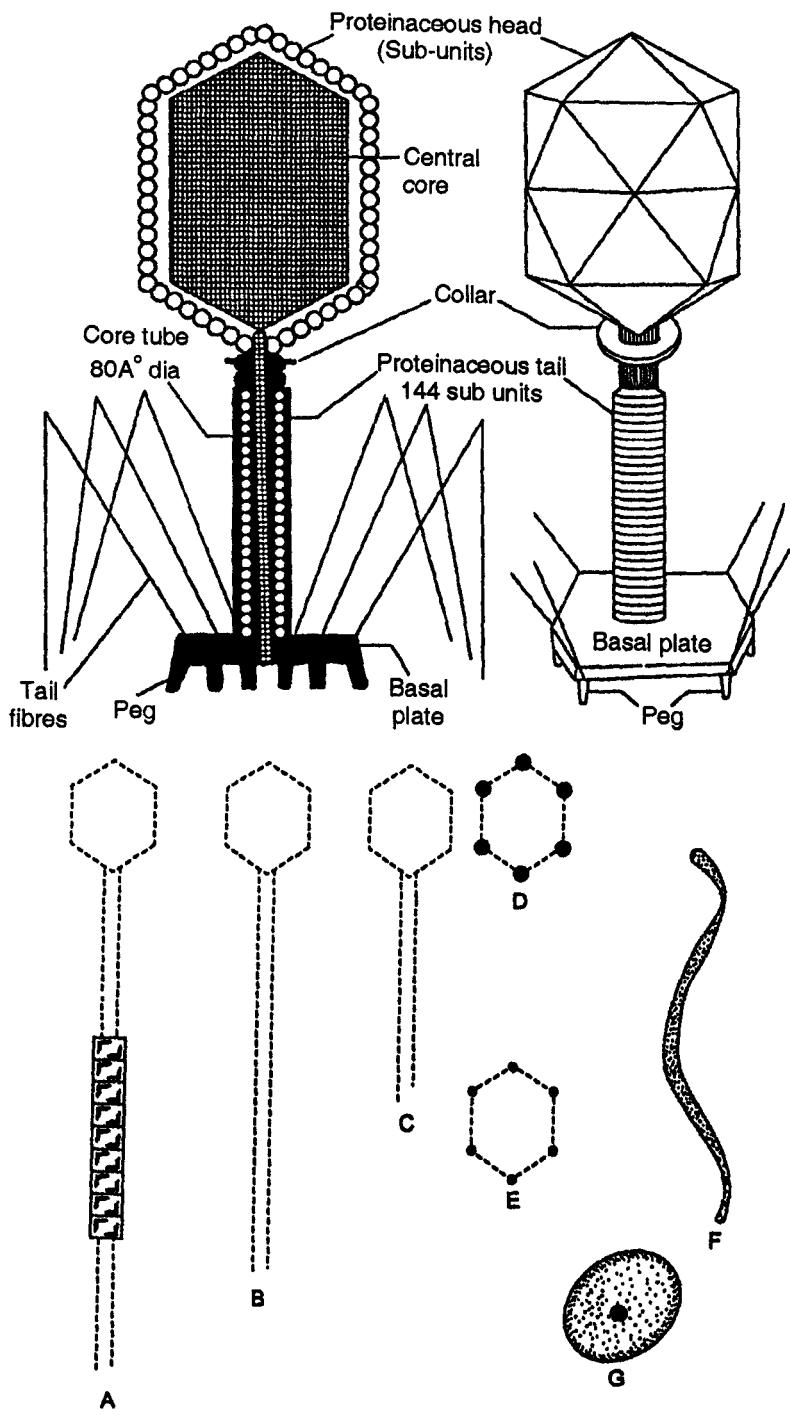
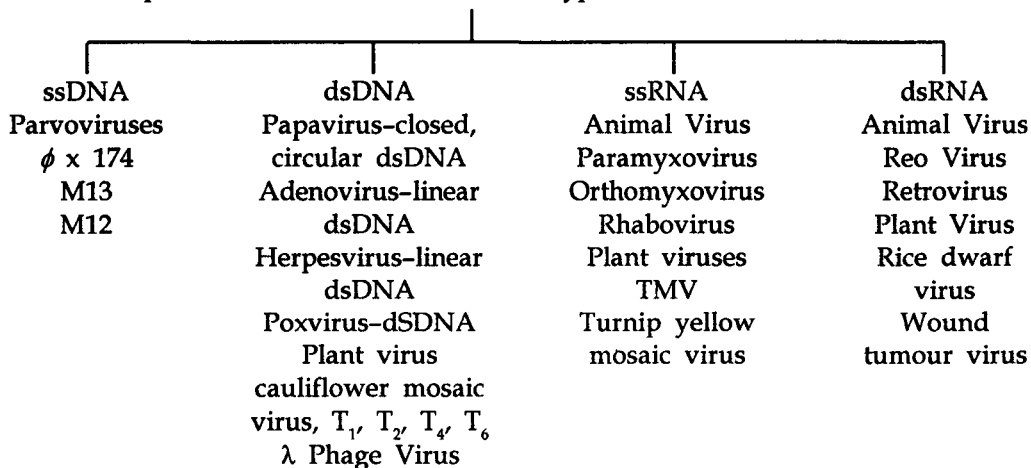

Fig. 2 : Structure of T₄ bacteriophage and structure of various morphological forms of Bacterial viruses

VIRAL GENOME

It contains all genetic information. Viruses may contain DNA or RNA which may be single or double stranded, linear or circular. Some may have plus polarity while others may have minus polarity. Usually the animal viruses contain DNA but a number of these contain RNA instead of DNA. Similarly the plant viruses contain RNA but a number of these contain DNA.

With respect to the number of strands, four types of nucleic acids are found in viruses:



CLASSIFICATION

In (1927), Johanson was the first to attempt for the classification of plant viruses.

Holmes (1948) kept viruses under the order virales and classified them into three orders on the basis of host attacked.

1. Phaginae - infect bacteria
2. Phytophaginae - infect plants
3. Zoophaginae - infect animals

Lwoff, Horne and Tournier (1962) proposed a system of classification called LHT system based on :

- (i) Type of nucleic acid (DNA/RNA)
- (ii) Symmetry (helical/cubical/bilateral)
- (iii) Presence or absence of envelope around nucleocapsid.
- (iv) Diameter of helical capsid.
- (v) Number of capsomeres in cubic types.
- (vi) Molecular weight of virus.
- (vii) Shape and size of virus.
- (viii) Diameter of coiled nucleocapsid/number of capsomers in cuboidal shape.
- (ix) Diameter of nucleocapsid in coiling.
- (x) Intracellular multiplication.
- (xi) Mode of virus transmission.

The LHT system is not a natural classification system and does not show any evolutionary phylogentic relationship. It classifies virus on the basis of common chemical and structural features which can be accurately determined.

Classification according to the provisional committee on nomenclature of viruses (PNVC) of the International Association of Microbiological societies based on the system of Lwoff, Horne and Tournier (1962) is as follows :

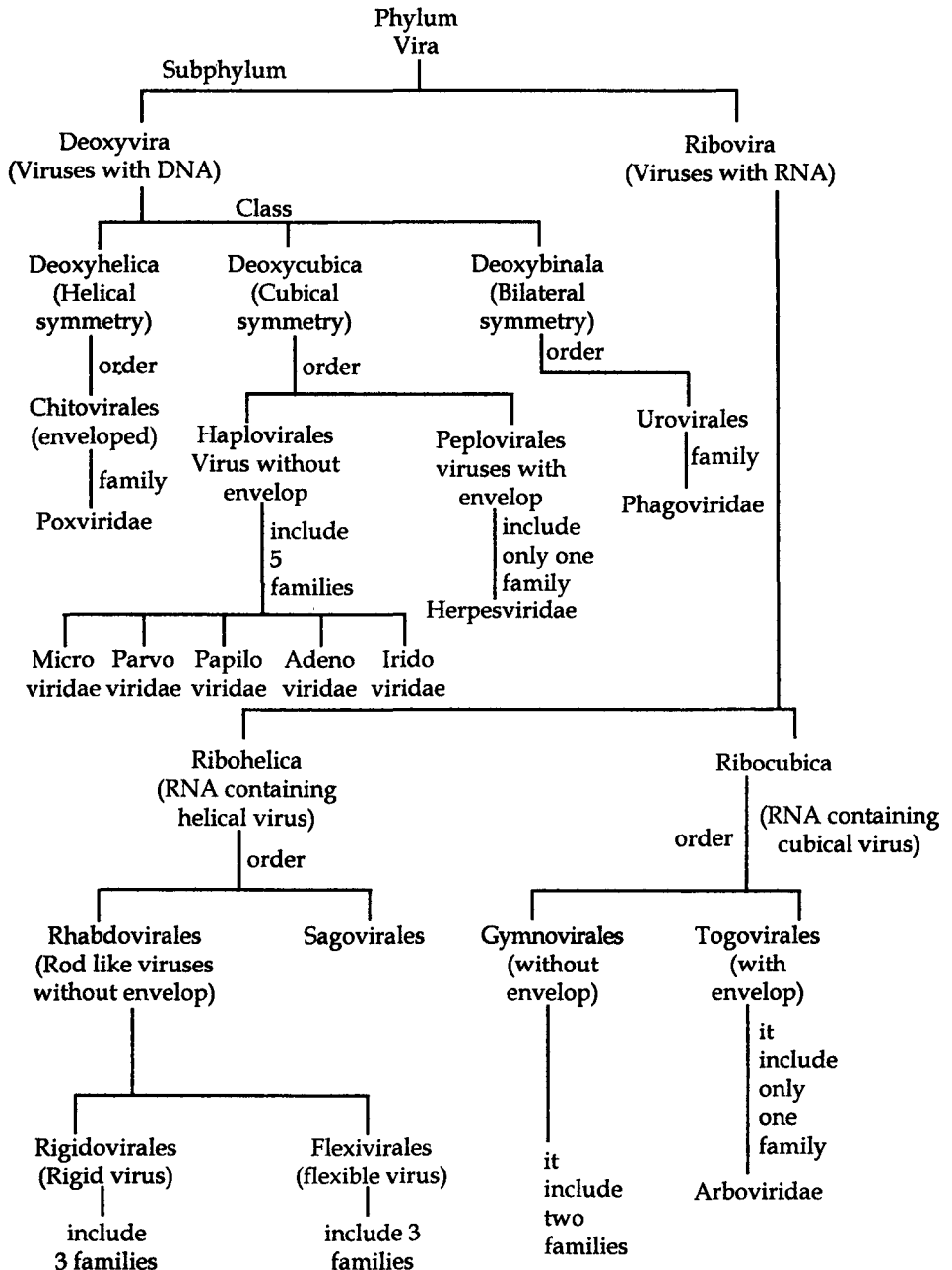

Classification by Gajens and King (1975)

The major groups of virus are classified according to the type of nucleic acid, symmetry, presence or absence of an envelope and site of assembly (nuclear or cytoplasmic) of capsid with genetic material.

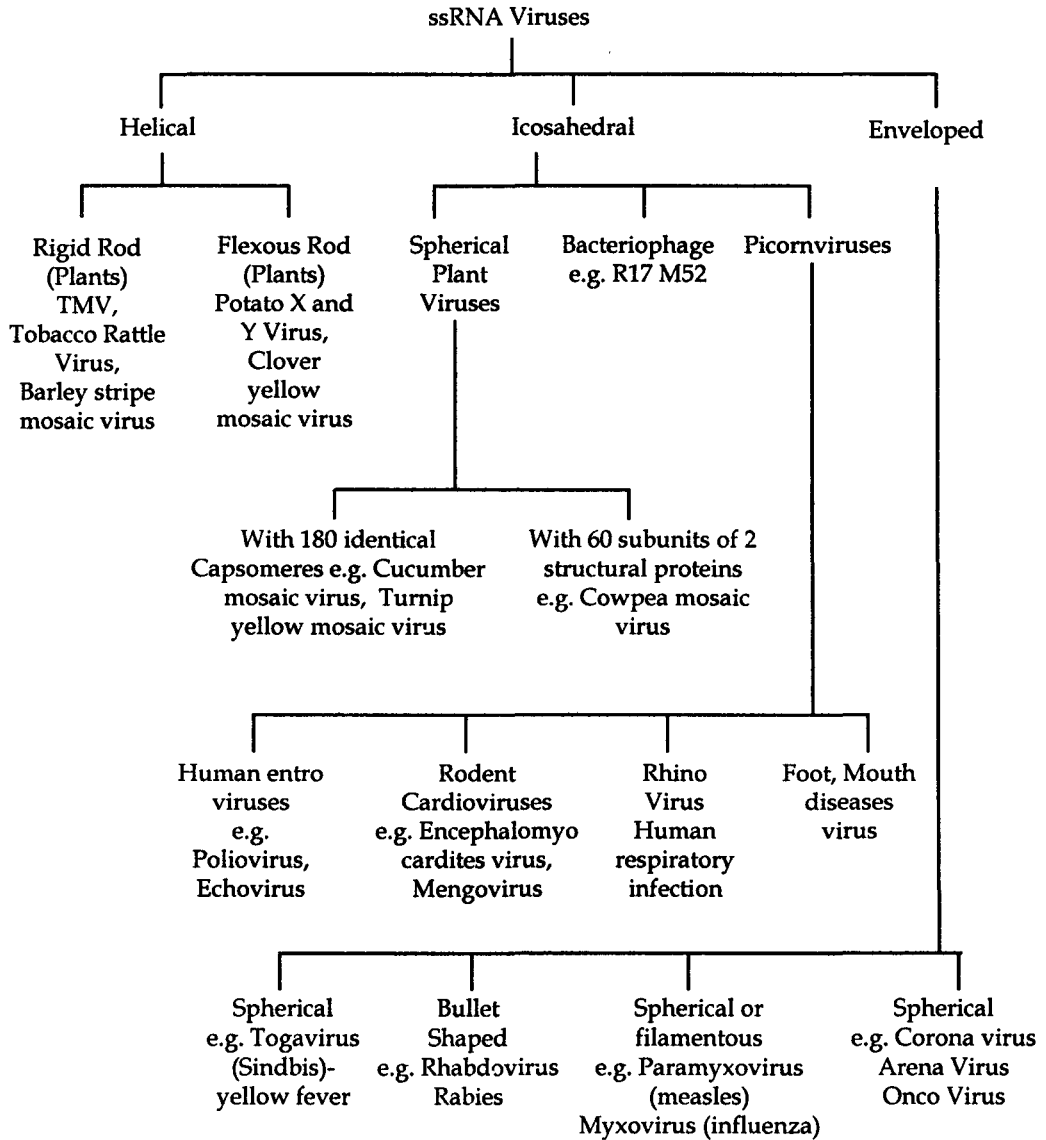

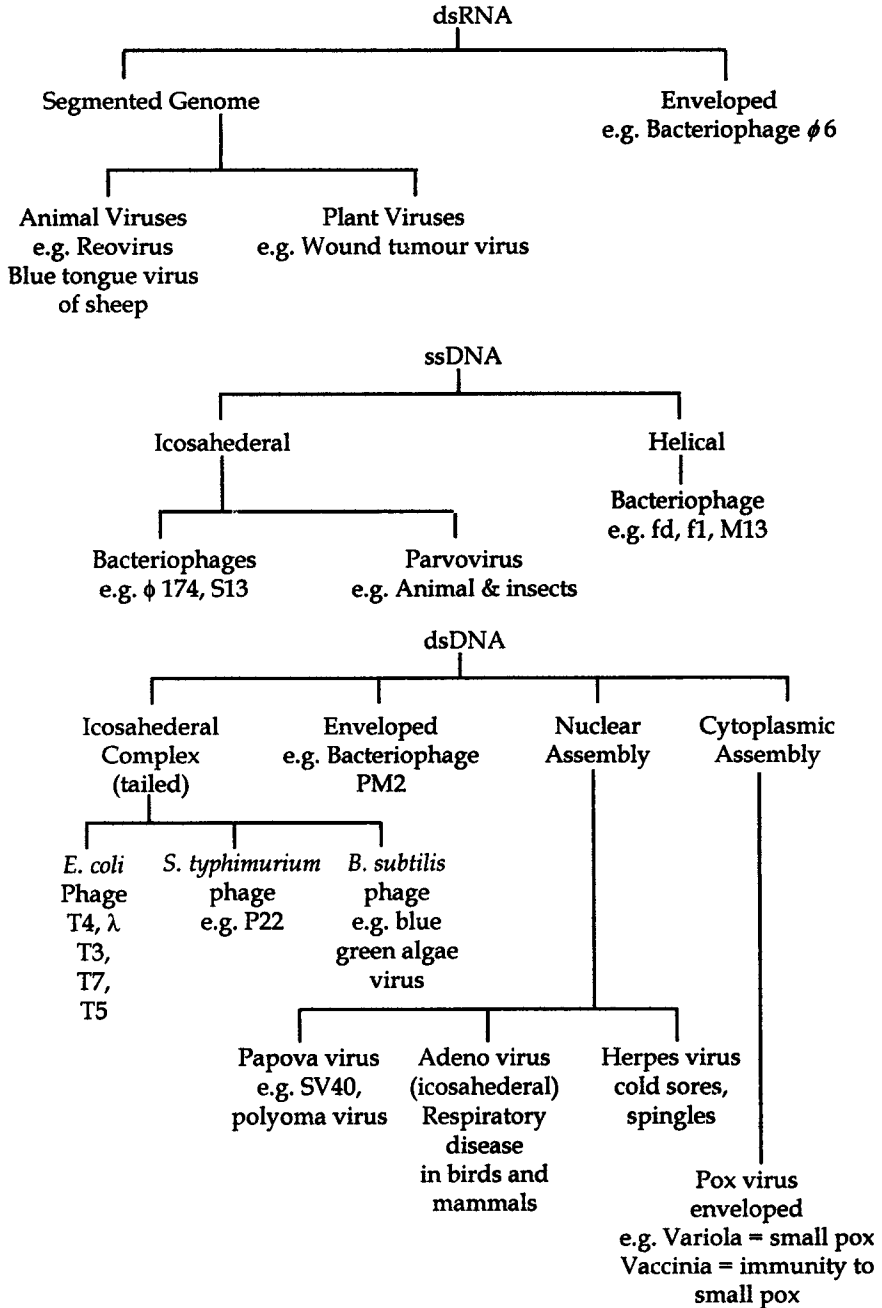

David Baltimore, a nobel laureate, proposed a scheme that encompassed all viruses, based on their genomes nature and their modes of replication and gene expression. The international committee on taxonomy of viruses (ICTV) uses these, together with other parameters to place viruses into families and genera.

The revised Baltimore scheme is based on the fundamental importance of mRNA in the replication cycle of viruses. Accordingly, viruses are grouped according to their mechanism of mRNA synthesis and their replication strategy. By convention all mRNA is designated as positive (+) sense RNA. Strands of viral DNA and RNA that are complementary to the mRNA are designated as negative (-) sense and those having the same sequence are termed +ve sense. In this way 7 classes of nature of virus genomes in that class.

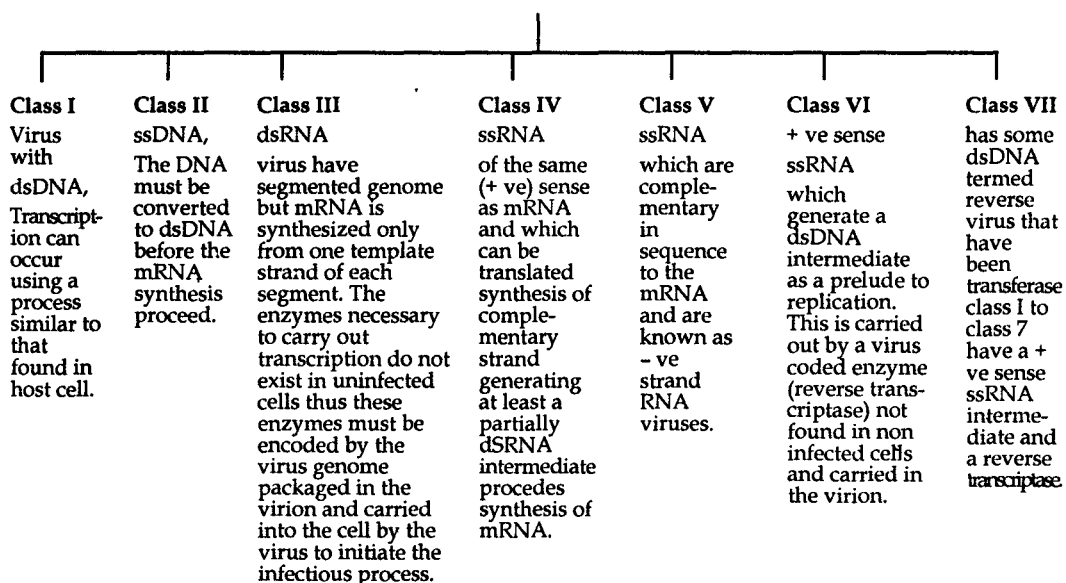

All mRNA = + or positive

Viral DNA/RNA = complementary to mRNA = - ve or minus

Some sequence of mRNA = positive sense

Nomenclature: A new method of classification is given by International committee for virus nomenclature to name viruses. Binomial system of nomenclature is not suitable for naming viruses. According to new nomenclature a virus name has two parts - 1st name is the common name of virus while in the 2nd part it contain the code adopted for describing a virus- is called Cryptogram. It is based on 4 pairs of symbols.

- (a) The 1st pair indicates, type of nucleic acid/number of strands of nucleic acid.
- (b) The 2nd pair indicates, molecular weight of nucleic acid (in millions)/percentage of nucleic acid.
- (c) The 3rd pair indicates, outline of the particle/outline of nucleocapsid.
- (d) The 4th pair indicates, kind of host infected/nature of vector eg. Cryptogram

of TMV is R/1 : 2/5: E/E : S/O. It means it contain RNA - one stranded (SS); molecular weight of RNA is 2 millions, it makes 5% of virus particle, the particle and nucleocapsid are elongated with parallel sides; ends not rounded it infects seed plants and no vector is needed.

REPLICATION OF VIRUSES

All viruses are entirely parasitic. They do not show any metabolic activity except (multiplication) self-duplication that too only within the host cytoplasm. Viruses require specific host cells for their multiplication.

Two different types of life cycles are exhibited by bacteriophage, virulent or lytic cycle and temperate or lysogenic cycle. In the former the intracellular phage multiplication results in the lyses or disintegration of the cell of the host bacterium and then final release of the progeny virions. In later no harm is caused to the cell of the host bacterium and the nucleic acid of the virus is first inserted in the bacterial (host) DNA and then replicates along with bacterial DNA. Bacteria containing prophages are called lysogenic bacteria and those viruses whose nucleic acid can become prophage (i.e. gets incorporated in bacterial DNA) are known as lysogenic, temperate or avirulent phages (eg. F_2 , M_{12}).

Lytic or Virulent Cycle

The major events involved in the lytic cycle of T-even phages are:

- (1) Attachment of phage particle to the host.
- (2) Adsorption of virus particle.
- (3) Penetration into the host.
- (4) Replication of viral nucleic acid.
- (5) Protein synthesis.
- (6) Assembly of new virions.
- (7) Release of mature viruses

(1) **Attachment to the host:** Random collision brings the phage particles in contact with the bacterial cells. The tail plate of the phage attaches to the surface of a susceptible host bacterium along with tail fibres. Specific components of the protein capsid are known to be involved in the process of attachment of the virus to a specific receptor sites of the host bacterial cell. In *E.coli* such sites are located in outer lipoprotein layer of peptidoglycan layer.

(2) **Adsorption:** When the contact is made between tail fibres and bacterium, it becomes unfolded from the tail. Unfolding and release of tail fibres from whiskers are governed by certain co-factors for eg. tryptophan is needed (1 mg/ml). The whole process of interaction of phage to recognition of specific receptor site is known as landing (A) After landing there starts the second process of adsorption which is known as pinning (B). Before pinning the phage can move attached with tips of tail fibres to cell surface until it finds the site for pinning of spikes. Pinning is the irreversible process. All the activities before pinning are reversible.

After pinning the tail sheath contracts and therefore, appears shorter and thicker (C). Sheath contracts by rearrangement of discs from 24 to 12. The phage uses its energy in tail contraction as ATP. The activity of phage contraction is comparable to that of microsyringe (D). The base plate through the centre enlarges after contraction of sheath. After making the contact with a component of plasma membrane, unplugging of phage DNA begins (E). Thereafter, DNA is injected into the cell without requiring metabolic energy. (F) Phage head and tail remain outside the cell. Such empty protein coats are known as 'ghosts'.

The adsorption of the virus particles is a specific process for which the presence of some cations is necessary. Both cells and virus particles are negatively charged at pH 7 and positive ions are therefore required as counter ions. The second stage involves the interaction of virus particles with specific receptor most of which appears to be glycoproteins. The number of virus particles or infectious units adsorbed per cell is referred to as the multiplicity of infection (moi). Animal cells are usually capable to adsorbing very large amounts of virus, the number of receptors of most viruses ranges from 100,000 - 500,000/cells.

(3) Penetration into the host: Adsorption is followed by penetration of nucleic acid of the phage into the bacterial cell. Actually it is like an injection through a syringe. The end plate and the tail fibres are held firmly against the bacterial cell. It causes the hollow core of the phage tail to pierce through the bacterial cell wall and possibly the plasma membrane. At this stage the contractile tail sheath functions like a muscle. It derives the energy from ATP present in the tail of the phage. Through the hollow core of the contracted tail the phage DNA is injected or penetrated into the body of the bacterium. Lysozyme, present on the phage tail, may also facilitate the DNA penetration by producing a hole on the bacterial wall. After the completion of the penetration process. The empty head and the tail of the phage remain outside the bacterium as the empty shell. Such empty shells are called ghosts.

(4) Replication of viral nucleic acids: Successful penetration of DNA will result in the production of its many replicas. Enzyme are also involved in the replication of nucleic acid. This replication in the double stranded DNA viruses occur in the nuclear material of the host cell, so does the transcription. Replication process causes several changes in the metabolism of the host cell.

(5) Protein synthesis: The phage nucleic acid, once inside the bacterial cell, takes over the protein synthesis machinery of the cell. It suppresses the synthesis of bacterial protein and directs the metabolism of the cell to synthesize the proteins of the phage particle. This is accomplished by the synthesis of viral specific m-RNA. The replication of phage DNA follows the semi conservative mechanism. Most of the phage DNA serves as a template in its own synthesis and the rest is used as a template for the synthesis of viral specific m-RNA. The later directs the host cell to synthesize proteins which are used as a subunits (capsomeres) of the protein coat of the phage particle. These protein are called late proteins as mentioned above. After the penetration of phage DNA some enzyme are first synthesized. These enzymes are necessary for building complex molecule peculiar to the phage, and represent early proteins. Subsequently, late proteins appear, which include the protein subunits of head and tail of the bacteriophage.

(6) **Assembly of new virions:** The DNA of phage and proteins of its head and tail are synthesized separately in the bacterial cell. The phage DNA is condensed into a compact polyhedron and packaged into the head. Finally the tail structures are added and thus new virion is assembled. The process of assembly of different components of the phage into the new mature virions is called 'maturation' process or 'morphogenesis process'.

(7) **Release of mature viruses:** It is the final step of infection cycle. The entire cycle of phage development is completed in 30-90 min. In an infected bacterium 7-8 phage particles are formed/minute and a total of about 200 phages are formed in a bacterium. During the process of phage replication the bacterial cell wall is weakened. It is facilitated by the enzyme lysozyme, secreted by the phage DNA in the host cell. This enzyme causes the lysis or bursting of cell wall. Such a disintegration or lysis of cell wall releases the mature daughter phages. These liberated phages may again infect the bacterial cells.

Events of life cycle of T_4 bacteriophage in bacterial cell after penetration

Time (min)	Events
After Penetration	
0	Adsorption on bacterial cell wall and penetration.
1	Inhibition in synthesis of host DNA, RNA and proteins.
2	Synthesis of first mRNA.
3	Degradation of bacterial DNA.
5	Initiation of synthesis of T_4 DNA.
9	Synthesis of late mRNA.
12	Completion of synthesis of head and tail.
15	Appearance of first phage particle.
22	Bacterial lysis and release of about 300 progeny phages.

Lysogenic Cycle

The two characteristic features of lysogenic bacteria are immunity and induction. The prophage which is incorporated into the bacterial (host) genome, may be inherited just like any bacterial gene and may be carried indefinitely in the inert condition. The presence of prophage confers immunity on the bacterial cell against super infection.

The lysogenic state is brought about in two stages establishment and maintenance. Establishment of lysogeny requires the integration (insertion) of the phage genome into the bacterial chromosome and the beginning of repressor synthesis to prevent expression of genes bringing about lysis. Establishment requires the participation of three control genes C_I , C_{II} and C_{III} , maintenance of lysogeny only requires that repressor synthesis continue.

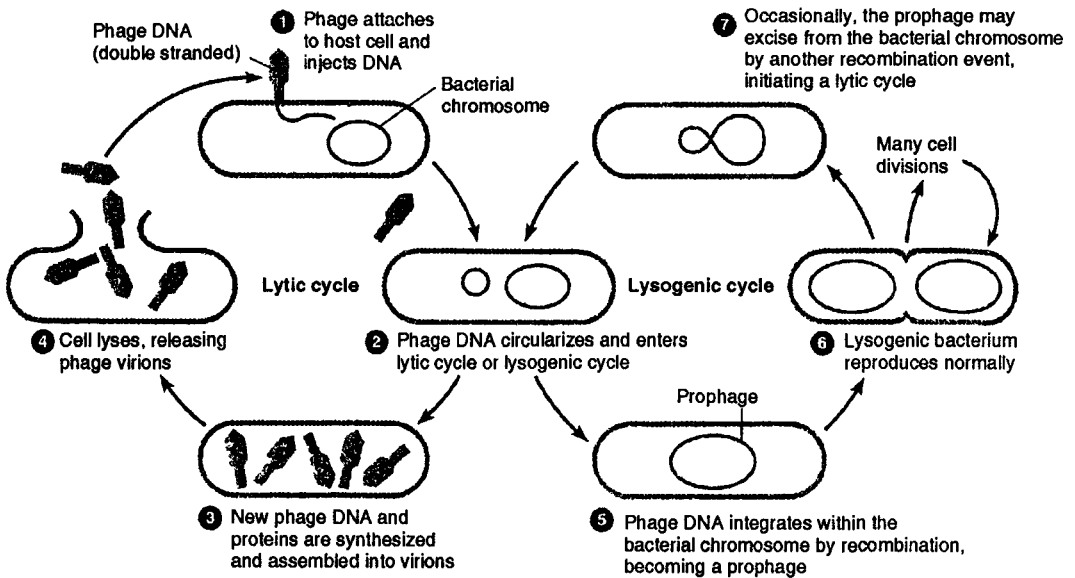

Fig. 3 : Stages of replication of bacteriophage in bacterial cycle

Interferon: Hoskins (1953) found that monkeys injected with one strain of yellow fever virus protected against a second strain. This effective protection was called virus interference by Findlay and Maccallum (1935). Issacus and Lindenmann (1957) found that a substance is produced by infected cell was responsible for it. They called it interferon.

Cells infected by viruses produce interferon which is antiviral and spreads to neighbouring cells and makes them resistant to virus infection by inhibiting virus growth. These are species-specific i.e. interferon from one organism does not provide protection against viruses to the cells of another organism. The interferon first marketed under the trade name was 'Intron'.

BACTERIAL VIRUSES

Viruses that use bacterial cells as hosts are called bacteriophages. There is hardly a single species of bacteria where sufficient investigation has not found a phage. The presence of bacteriophage is recognized by the appearance of 'plaques' or lytic holes in a continuous bacterial lawn. Phage nucleic acid occurs either as double or single stranded nucleic DNA or as a double or single stranded RNA.

FILAMENTOUS SINGLE-STRANDED DNA BACTERIAL VIRUSES

The filamentous DNA phages, which have helical rather than icosahedral symmetry, the most studied member of this group is phage M13, which infects *Escherichia coli*, but related phages include f1 and fd. As with the small RNA bacteriophages, these filamentous DNA phages infect only conjugational donor cells, entering after attachment to the pilus. Even though these phages are linear (filamentous) in shape, like Φ X174 they possess circular single-stranded DNA.

Phage M13

Phage M13 is the model filamentous bacteriophages. The phage has found extensive use as a cloning vector and DNA-sequencing vehicle in genetic engineering. The virion of phage M13 is only 6 nm in diameter but is 860 nm long. These filamentous DNA phages have the additional interesting property of being released from the cell without lysing the host cell. Thus, a cell infected with phage M13 can continue to grow, all the while releasing virions. Virus infection causes a slowing of cell growth, but otherwise a cell is able to coexist with its virus. Typical plaques are thus not observed; instead, only areas of reduced turbidity occur within a bacterial lawn.

Many aspects of DNA replication in filamentous phages are similar to those of Φ X174. The property of release without cell killing occurs by budding. In this mechanism, the

end of the virion containing several copies of a protein known as the A-protein is released first, with the remainder of the virion. With phage M13 there is no accumulation of intracellular virions as with typical bacteriophages. Instead, the assembly of mature M13 virions occurs on the inner surface of the cytoplasmic membrane and virus assembly is coupled with the budding process.

Several features of phage M13 make it useful as a cloning and DNA sequencing vehicle. First, it has single-stranded DNA, which means that sequencing can easily be carried out by the Sanger dideoxynucleotide method. Second, a double-stranded form of genomic DNA essential for cloning purposes is produced naturally when the phage produces the replicative form. Third, as long as infected cells are kept in the growing state, they can be maintained indefinitely with cloned DNA, so a continuous source of the cloned DNA is available. And finally, like phage lambda, there is an intergenic space in the genome of phage M13 that does not encode proteins and can be replaced by variable amounts of foreign DNA. For these and other reasons, phage M13 is an important part of the biotechnologist's toolbox.

BACTERIAL VIRUS T4

The first viruses to be studied in any detail were a number of bacteriophages with linear, double-stranded DNA genomes that infect *Escherichia coli* and a number of related Bacteria. Virologists began isolating and studying these viruses as model systems for virus replication and used them to establish many of the fundamental principles of molecular biology and genetics. These phages were given designations of T1, T2 and so on upto T₇.

Bacteriophages T2, T4, and T6 are closely related viruses, but T4 is the most extensively studied. The virion of phage T4 is structurally complex. It consists of an elongated icosahedral head whose overall dimensions are 85 x 110 nm. To this head is attached a complex tail consisting of a helical tube (25 x 110 nm) to which are connected a sheath, a connecting "neck" with "collar", and a complex end plate, to which are attached long, jointed tail fibers. Altogether, the virus contain over 25 distinct types of structural proteins.

The length of DNA contained in these bacteriophages is only about 6% that contained in *E.coli*. The bacteriophages has enough DNA for over 100 genes. The genome of T4 is a double-stranded linear DNA molecule of 168,903 base pairs. The T4 genome encodes over 250 different proteins, and although no known virus encodes its own translational apparatus, T4 does encode several of its own tRNAs. While the T4 genome has a unique linear sequence, the genome in one virion may not be exactly the same as that of another. This is because the DNA of phage T4 is circularly permuted. Molecules that are circularly permuted appear to have been linearized by opening a circle, but at different locations. In addition to circular permutation, the DNA in each T4 virion has repeated sequences at each end called terminal repeats of about 3-6 kbp. Both of these factors affect genome packaging.

The terminally redundant T4 DNA infecting a single host cell is first replicated as a unit, and then several genomic units are recombined end-to-end to form a long DNA

molecule called a concatemer. The packaging mechanism of T4 DNA involves cutting a segment of DNA from the concatemer sufficient to fill a phage head (at least one genomic equivalent) rather than cutting the DNA at a specific sequence. Since the T4 head holds slightly more than a genome length, this 'headful mechanism' leads to circular permutation and terminal redundancy. T4 DNA contains the modified base 5-hydroxymethylcytosine instead of cytosine. It is these residues that are glucosylated and DNA with this modification is resistant to virtually all known restriction enzymes. Consequently, the incoming T4 DNA is well protected from host defenses. The multiplication cycle of these phages like that all viruses (as mentioned in chap 9) can be divided into five distinct stages viz. attachment, penetration, biosynthesis, maturation and release.

Multiplication in T4 Phage

Things happen rapidly in a T4 infection. Early in infection T4 directs the synthesis of its own RNA and also begins to replicate its unique DNA. About 1 minute after attachment and penetration of the host by T4 DNA, the synthesis of host DNA and RNA ceases, while transcription of specific phage genes begins. Translation of viral mRNA begins soon after, and within 4 minutes of infection, phage DNA replication has begun.

The T4 genome can be divided into three parts, encoding early proteins, middle proteins, and late proteins, respectively. The early and middle proteins are primarily enzymes involved in DNA replication and transcription, while the late proteins are the head and tail proteins and the enzymes involved in liberating the mature phage particles from the cell.

Although T4 has a very large genome for a virus, it does not encode its own RNA polymerase. The control of T4 mRNA synthesis involves the production of proteins that sequentially modify the specificity of the host RNA polymerase so that it recognizes phage promoters. The early promoters are read directly by the host RNA polymerase and involve the function of host sigma factor. Host transcription is shut down shortly thereafter by a phage encoded anti-sigma factor that binds to host σ^{70} and interferes with its recognition of host promoters.

Phage-specific proteins synthesized from the early genes also carry out covalent modifications on the host RNA polymerase α subunits and a few phage-encoded proteins also bind to the polymerase. These modifications change the specificity of the polymerase so that it now recognizes T4 middle promoters. One of the T4 early proteins, called MotA, recognizes a particular DNA sequence in middle promoters and guides RNA polymerase

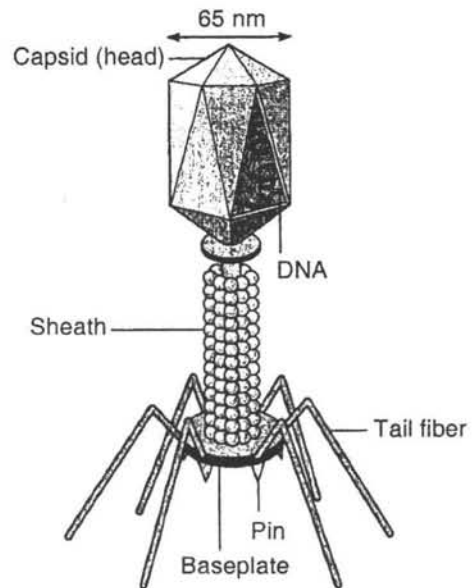

Fig. 1 : T-even bacteriophage

to these sites. Transcription from the late promoters requires a new T4- encoded sigma factor. Sequential modification of host cell RNA polymerase as described here for phage T4 is used to regulate gene expression by many other bacteriophages as well.

T4 encodes over 20 new proteins that are synthesized early after infection. These include enzymes for the synthesis of the unusual base 5- hydroxymethylcytosine and for its glucosylation, as well as an enzyme that degrades the normal DNA precursor deoxycytidine triphosphate. In addition, T4 encodes a number of enzymes that have functions similar to those of host enzymes in DNA replication but that are formed in larger amounts, thus permitting faster synthesis of T4 specific DNA. Additional early proteins include those involved in the processing of newly replicated phage DNA.

Most of the late genes encode structural proteins for the virion, including those for the head and tail. Assembly of heads and tails occurs independently; DNA is packaged into the assembled head and the tail and tail fibers are added later. Exit of the virus from the cell occurs as a result of cell lysis. The phage codes for a lytic enzyme, T4 lysozyme, which attacks the peptidoglycan of the host cell. After a lytic cycle, which takes only about 25 min, over 100 new virions will be released from each host cell, which itself has now been almost completely destroyed. The various stages involved in the multiplication of phages can be demonstrated experimentally in what is known as a one-step growth experiment. In this procedure, a phage suspension is diluted until a sample containing only a few phage particles is obtained. These particles are then introduced into a culture of host cells. Periodically samples of phage particles are removed from the culture and inoculated into a plate culture of susceptible host cells, the plaque method is used to determine the number of infective phage particles on this culture. A few minutes after attachment no infective particles are present. However phage nucleic acid is found inside the infected cells and capsid proteins will be synthesized. The time required for maturation is the interval between the appearance of phage nucleic acid and the synthesis of mature phages. After few minutes the number of infective phage particles found in sub cultures begins to rise. The burst size is determined once the number of infective phage particles remains constant indicating that no further phage multiplication will occur.

TEMPERATE BACTERIOPHAGES

Bacteriophages T4 is virulent. However, some other viruses, although also able to kill cells through a lytic cycle, have the option of undergoing a different life cycle resulting in a stable genetic relationship with the host. Such viruses are called temperate viruses. These viruses can enter into a state called lysogeny, where most virus genes are not expressed and the virus genome, called a prophage, is replicated in synchrony with the host chromosome.

The temperate phage genome can be replicated along with that of the host and during cell division be passed from one generation to the next. Under certain conditions cells that harbor a temperate virus, called lysogens, can spontaneously produce and release virions.

Lysogeny is probably of ecological importance because most bacteria isolated from nature are lysogens for one or more bacteriophages. Lysogeny can also confer new genetic properties on the bacterial cell.

In a typical lytic virus it is not the presence (or even the replication) of viral DNA

that leads to the production of new virions and host cell death. Rather it is expression of the viral genome that is deleterious. Host cells can harbor viral genomes without harm if the expression of the viral genes can be controlled. This is the situation found in lysogens. However, if this control is lost, the virus enters the lytic pathway and produces new virions, eventually lysing the host cell. Lysogeny can thus be considered a genetic trait of a bacterial strain.

The temperate virus does not exist in its extracellular form inside of the cell. Instead, the prophage is integrated into the bacterial chromosome and replicates along with the host cell as long as the genes controlling its lytic pathway are not expressed. Typically this control is maintained by a phage-encoded repressor protein (the gene encoding the repressor protein is expressed). The virus repressor protein not only controls the lytic genes on the prophage but also prevents the expression of any incoming genes of the same virus. This results in the lysogens having immunity to infection by the same type of virus.

If the phage repressor is inactivated or if its synthesis is prevented, the prophage is induced. Induction results in the production of new virions and the lysis of the host cell. In some cases, induction can be brought about by environmental conditions. If the virus loses the ability to leave the host genome (because of mutation), it becomes a cryptic virus. Genomic studies have shown that many bacterial chromosomes contain DNA sequences that were clearly once part of a viral genome. Thus the establishment and breakdown of the lysogenic state is likely a dynamic process in prokaryotes.

BACTERIOPHAGE LAMBDA OR λ PHAGE

One of the best-studied temperate phages is lambda, which infects *Escherichia coli*. Morphologically, lambda virions look like those of many other tailed bacteriophages, although unlike phage T4, no tail fibers are present. The genome of lambda consists of a linear double-stranded DNA molecule, but at the 5' terminus of each of the strands is a single-stranded tail 12 nucleotides long. These single-stranded ends are complementary (the ends of the DNA are said to be cohesive). Thus, when the two ends of the DNA are free in the host cell they associate (the cos site), and the DNA is ligated to form a double-stranded circle of 48,502 base pairs.

Lambda Infection and the Lytic Pathway

The lambda virion attaches to a specific receptor protein in the cell wall of *Escherichia coli* and injects its DNA. The DNA circularizes almost immediately and expression of the phage genome begins. The first steps in gene expression are the same whether the final result is lysis or lysogeny. This replication shows an interesting example of molecular level control of gene expression. The completion of rightward transcription of the phage genome requires the expression of Q gene expression. The complete counter clock wise transcription of the lambda genome requires the expression of the N gene that codes for an N protein. Both the N and Q genes must be expressed for the transcription of the complete genome. The λ phage genome contains a CI gene which codes for a repressor protein that binds to the operator that controls the expression of N protein. In the absence of N protein synthesis the replication of λ phage DNA can't proceed. The repressor protein also binds to another operator region, blocking the rightward transcription of the λ phage DNA and thus the

production of Q protein. This leads to a conversion to lysogenic replication. During the lytic replication cycle of λ , transcription begins at two promoter sites during early replication one of the promoter site initiates rightward transcription P_{R1} , the other initiates leftward transcription P_{L1} . Production of RNA using host RNA polymerase begins at two key promoters called P_L (promoter left) and P_R (promoter right). These yield short transcripts that are translated to give the products of the N and the cro genes, both proteins being involved in regulatory events. The Cro protein regulates whether the lytic or the lysogenic pathway is followed. The N protein is an *antiterminator* that allows that RNA polymerase to transcribe past specific terminators, extending the transcripts from P_L and P_R . These longer transcripts can be translated to yield more proteins, including the products of the cII and cIII genes. The N protein is not completely effective at the terminator before the Q gene, and so only a small amount of the Q protein is made.

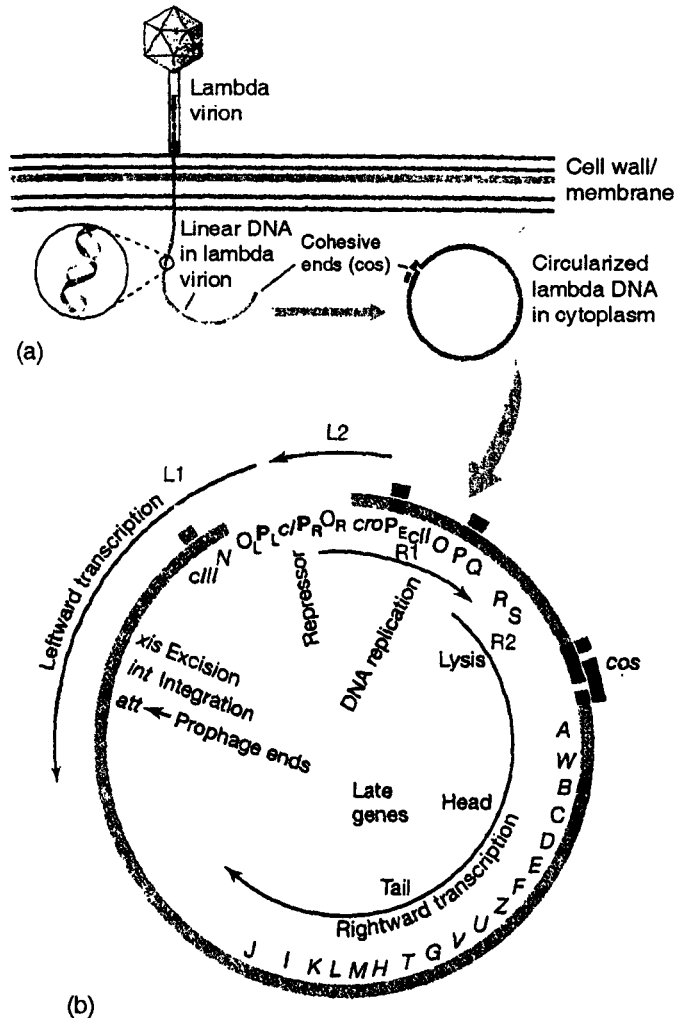

Fig. 2 : The lambda genome

The Q protein is also an antiterminator protein. If its concentration becomes high enough, it will allow the transcript from a nearby promoter to synthesize the transcript labeled R2. This transcript is translated to yield the late proteins, all the necessary structural proteins to construct a virion, and the proteins necessary for cell lysis. However, at the same time the Q protein is accumulating, the Cro protein also reaches levels where it can block transcription from both P_L and P_R by binding to both O_L (operator left) and O_R (operator right). Therefore, Cro functions as a repressor protein.

In the mechanism of Cro protein binding to O_R is observed that there are three similar but non identical sites at this operator where the Cro protein can bind. It does so first at site 3, and then site 2, and only when those two sites are filled, at site 1 once P_L and once P_R are blocked, no more cII or cIII proteins can be synthesized. These proteins are needed to enter the lysogenic pathway. Thus, when Cro is made in high amounts, lambda is irreversibly committed to the lytic pathway.

The shut off of P_L and P_R results in a change of lambda DNA replication. Early DNA synthesis is bidirectional from a single origin and gives rise to typical theta-like intermediates. However, by the time late proteins are being made, long, linear concatamer of DNA are synthesized by rolling circle replication. In this mechanism and unlike semi conservative replication, replication proceeds in only one direction and can result in very long chains of replicated DNA. Rolling circle replication permits rapid DNA replication and thus is a useful mechanism for rapidly accumulating copies of the lambda genome to package into mature virions. The long concatemers are cut into virus-sized lengths by a DNA-cutting enzyme. In the case of lambda, the cutting enzyme cuts at specific sites on the two strands (the cos sites), 12 nucleotides apart, providing the cohesive ends involved in the cyclization process. The linear DNA is then packaged into phage heads and the tails and other proteins added. The cell is then lysed by the activity of phage-encoded enzymes, and the lambda lytic cycle is complete. In a nutshell, If Cro dominates regulatory events, the outcome is lysis, while if the lambda repressor dominates, lysogeny will occur.

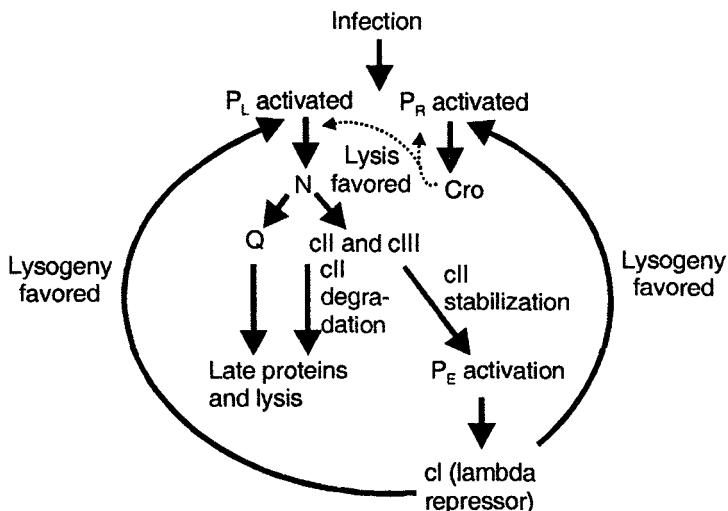

Fig. 3 : Summary of the steps in lambda infection

Integration of λ DNA in *E. coli* Chromosome

Integration of lambda DNA occurs at a unique site on the *Escherichia coli* chromosome & is required to complete the lysogenic state. Integration occurs by insertion of the virus genome into the host genome (thus effectively lengthening the host genome by the length of the virus DNA) upon injection, the cohesive ends of the linear lambda molecule find each other and form a circle, and it is thus circular DNA that becomes integrated into the host genome (the site created when these ends join is called *cos*). To establish lysogeny, genes *cI* (lambda repressor) and *int* (encoding integrase) must be expressed. The integration process requires lambda integrase, which is a site-specific nuclease/integrase-catalyzing recombination of the phage and bacterial attachment sites. The *int* gene has a promoter that, like $P_{E'}$, is activated by the *cII* protein.

BACTERIAL VIRUS T7

Bacteriophage T7, a representative T-odd phage, has a small linear double-stranded DNA genome. The DNA is injected linearly into bacterial cells after the phage attaches to a host cell, most commonly *E. coli*. Transcription of the T7 genome begins immediately after penetration. Host cell RNA polymerase initiates RNA synthesis at closely spaced promoters of the phage DNA end. Host RNA polymerase is used to copy the first few phage genes, called early genes. It also makes mRNA for the phage-specific RNA polymerase that is used in the major RNA transcription process that occurs during replication of this phage.

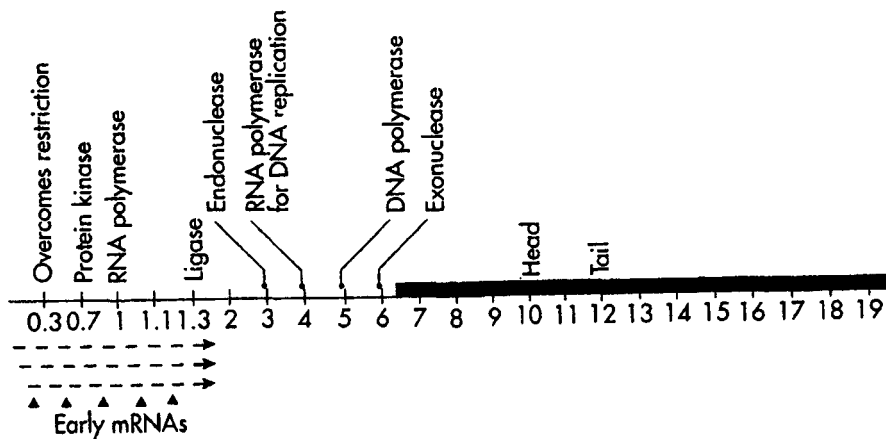

Fig. 4 : Linear genome of T7 bacteriophage

Transcription generates a set of overlapping polygenic mRNA molecules. These mRNA molecules are then cut by a host-specified RNaseIII that acts at several sites. This generates smaller mRNA molecules that code for one to four proteins each. One of these proteins is an RNA polymerase that copies double-stranded DNA. Two others code for proteins that stop host RNA polymerase action. This turns off early gene transcription and translation of host genes.

The T7 phage strongly affects host transcription and translation processes by producing proteins that turn off transcription of host genes. This phage has genes coding for enzymes that degrade host cell DNA. Nucleotides from degraded DNA are incorporated into phage progeny. Late genes expressed, beginning 6 minutes after infection, code for enzymes involved in DNA replication. Regulation of T7 gene expression is both positive and negative. Negative control is by means of the formation of proteins that stop host RNA polymerase and shut off early T7 gene transcription. Positive control is by the formation of new RNA polymerase that recognizes the rest of the T7 promoters.

A structural feature of T7 DNA that is important for its replication is a direct terminal repeat of 160 bp at both ends of the molecule. To replicate DNA near the 5' terminus, RNA primer molecules have to be removed before replication is complete. There is thus an unreplicated portion of the T7 DNA at the 5'-terminus of each strand. Genetic elements composed of linear DNA employ various strategies for solving this problem in DNA replication. The strategy employed by T7 is similar to that used by T4 and involves the repeated sequence at its ends. The opposite single 3'-strands on two separate DNA molecules, being complementary, can pair with these 5'-strands, forming a DNA molecule twice as long as the original T7 DNA. The unreplicated portions of this structure are then completed through the activity of T7 DNA polymerase and ligase, resulting in a linear bimolecule called a concatemer.

Continued replication & recombination can lead to concatemers of considerable length, but ultimately a phage-encoded endonuclease cuts each concatemer at a specific site, resulting in the formation of virus-sized linear DNA molecules with terminal repeats. Because T7, like lambda but unlike T4, cuts the concatemer at specific sequences, the DNA sequence in each T7 virion is identical. This is not the case in phage T4. This phage processes DNA using a 'headful mechanism', which means that its DNA is not only terminally redundant but is also circularly permuted.

MU : A DOUBLE-STRANDED TRANSPOSABLE DNA BACTERIAL VIRUS

One of the more interesting bacteriophages is phage Mu. This virus is temperate, like lambda, but has the unusual property of replicating as a transposable element. This phage is called Mu because term Mu stands for mutator phage inducing mutations in a host genome into which it becomes integrated. The mutagenic property of Mu arises because the genome of the virus can be inserted within host genes, thus inactivating them. Hence, a host cell that has become infected with Mu can assume a mutant phenotype. Mu is a useful phage in bacterial genetics because it can be used to easily generate a wide variety of bacterial mutants. The unique property of Mu is that it contact as transposon within a host cell. Transposable elements are sequences of DNA that can move from one location on their host genome to another as discrete genetic units. They are found in both prokaryotes and eukaryotes and play important roles in genetic variation. Although a bacteriophage, Mu is in reality a very large transposable element that replicates its DNA by transposition.

Bacteriophage Mu is a large virus with an icosahedral head, a helical tail, and six tail fibers. The genome of Mu contains linear double-stranded DNA. It can be seen

that the bulk of the genes are involved in the synthesis of head and tail proteins and that important genes at each end of the genome are involved in replication and host range.

The DNA in Mu is approximately 39 kbp, but only 37.2 kbp constitute the actual Mu genome. This is because both ends of the Mu genome contain host DNA. At the left end of the Mu DNA are 50-150 bp of host DNA, and at the right end are 1-2 kbp of host DNA. These host DNA sequences are not unique but simply represent DNA adjacent to the location where Mu was inserted into the genome of its previous host.

When a Mu phage virion is formed, a length of DNA containing the Mu genome just large enough to fill the phage head is excised from the host. The DNA is packaged until the head is full, but the place at the right end where the DNA is cut varies from one virion to another, there is a variable sequence of host DNA at the right-hand end of the phage (right of the attR site). Thus, each virion arising from a single infected cell will be genetically unique, since it will have different host DNA.

A specific segment of the Mu genome called G is invertible, being present in the genome either in the orientation designated G^+ or in the inverted orientation G^- . The orientation of this segment determines the kind of tail fibers that are present on the phage. Since adsorption to the host cell is controlled by molecular interactions between the tail fibers and the cell surface, the host range of Mu is determined by which orientation of this invertible segment is present in the phage. For example, if the G segment is in the orientation designated G^+ , then the phage will make tail fibers that allow it to infect *Escherichia coli* strain K12. By contrast, if the G segment is in the G^- orientation, then the phage will infect *E. coli* strain C or several other species of enteric bacteria. The two tail fiber proteins are encoded on opposite strands within this small G segment.

Left of the G segment is a promoter that directs transcription into the G segment. In the orientation G^+ , the promoter directing transcription of genes S and U is active, whereas in the orientation G^- , a different promoter directs transcription of genes S' and U' on the opposite strand. Inversion of the G region is a rare event and is under the control of a gene adjacent to the G region. We thus see in the inversion phenomenon is a simple mechanism for attacking a variety of different host cells.

Replication of Mu

On infection of a host cell by Mu, the DNA is injected and is protected from host restriction by a modification system in which about 15% of the adenine residues are modified by acetylation or acetoamidated. Integration requires the activity of the gene A product, which is a transposase enzyme encoded by the phage. At the site where the Mu DNA becomes integrated, a 5-bp duplication of host DNA arises at the target site. This host DNA duplication arises because staggered cuts are made at the point in the host genome where Mu is inserted. The resulting single-stranded segments are converted to the double-stranded form as part of the Mu integration process. Duplication of short stretches of host DNA is typical of transposable element insertion. Mu DNA is transposed to multiple site of the bacterial chromosome when Mu integrates its gene around the bacterial chromosome it inserts phage DNA within bacterial genes causing mutation.

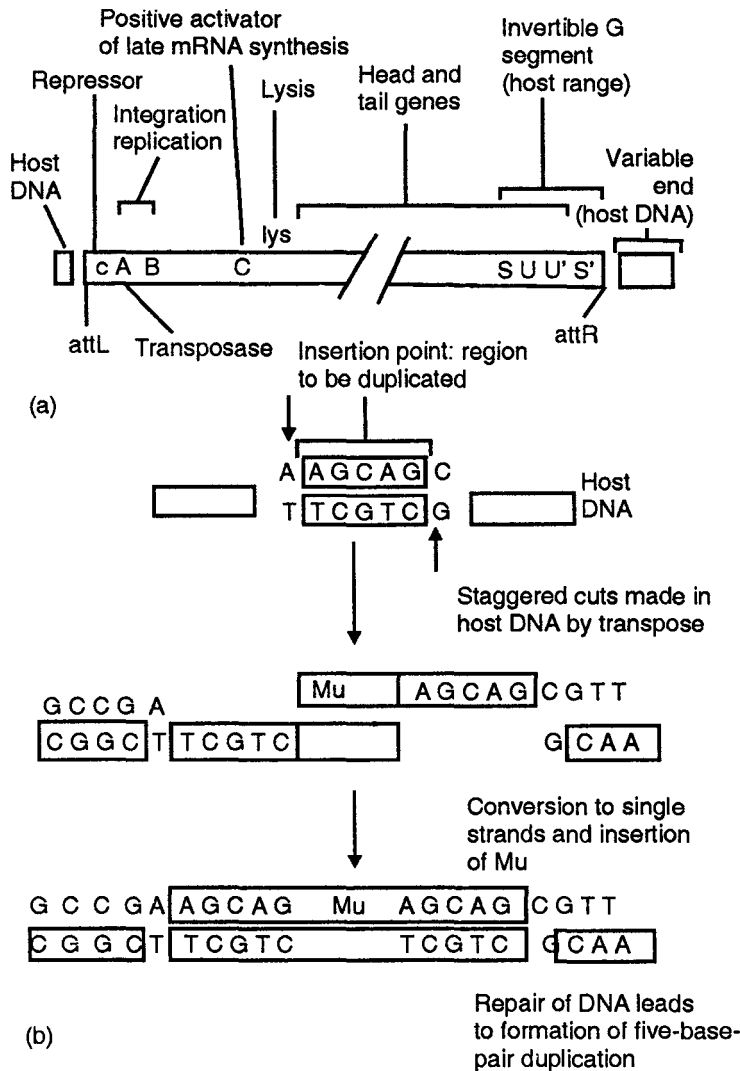

Fig. 5 : Replication of bacteriophages Mu

Lytic growth of Mu can occur either upon initial infection, if the Mu repressor (the product of the c gene) is not formed, or by induction of a lysogen. In either case, replication of Mu DNA involves repeated transposition of Mu to multiple sites on the host genome. Initially, transcription of only the early genes of Mu occurs, but after the C protein is expressed (C is a positive activator of late transcription), synthesis of the Mu head and tail proteins occurs. Eventually, expression of the lytic function occurs and mature phage particles are released. The lysogenic state in Mu requires the sufficient accumulation of repressor protein to prevent transcription of integrated Mu DNA.

9

PLANT VIRUSES

A virus is a nucleoprotein that has the ability to cause disease. It multiplies only in living cells and it is too small to be seen individually with a light microscope. All viruses are parasitic in cells and cause a multitude of diseases in all forms of living organisms from single celled microorganism to large plants and animals. The total number of viruses known to date exceeds 2000 and new virus are described every month. About one fourth of all known viruses attack and cause diseases in plants. One virus may infect one or dozens of different species of plants and each species of plant is usually attacked by many different kinds of viruses. A single plant may also be infected by more than one kind of virus at the same time.

Although viruses can take any of several forms, they are mostly rod or polyhedral shaped or the variant of these two basic structures. The genetic material is only RNA or only DNA.

Viruses cause disease not by consuming cells or killing them with toxins, but by utilizing cellular substances during multiplication, taking up space in cells and disrupting cellular processes and lead to the development of abnormal substances and conditions injurious to the functions and the life of the cell or the organism.

MORPHOLOGY

Morphologically the plant viruses came in different shapes and sizes. Generally they are elongate rigid rods and other are spherical like isometric or polyhedral and the remaining being cylindrical bacillus like rods. Some elongated viruses are rigid rods about 15×300 nm, but most appear as long, thin, flexible threads about $10-13 \times 480-2000$ nm. Most of the spherical viruses are polyhedral 17-60 nm.

Many plant viruses have split genomes, consisting of two or more distinct nucleic acid strands encapsidated in different sized particles made of the same protein subunits.

Many isometric viruses have two or three different components of the same size but containing nucleic acid strands of different length.

The surface of viruses consist of a definite number of protein subunits which are spirally arranged in the elongated viruses and packed on sides of the polyhedral particles of the spherical viruses. In transverse section the elongated viruses appear as hollow tubes with the protein subunits forming the outer coat and the nucleic acid, also spirally arranged, embedded between the inner ends of two successive spirals of the protein subunits. The rhabdoviruses and a few spherical viruses are provided with an outer lipoprotein envelope or membrane. Inside the membrane is the nucleocapsid consisting of nucleic acid and protein subunits. The nucleic acid makes up 5–40% of the virus protein making up the remaining 60–95%. The spherical virus contain higher percentage of nucleic acid whereas the low nucleic acid percentage is found in elongated virus. The weight of nucleic acid ranges between $1-3 \times 10^6$ dalton per virus particle. Although some have 6×10^6 dalton. All viral nucleic acid sizes are quiet small as compared to 0.5×10^9 dalton for mollicutes and 1.5×10^9 dalton for bacteria.

The protein shell of plant viruses are composed of repeating sub-units. The amino acid content and sequence for identical protein subunits of a given virus are constant but vary for different viruses and even for different strains of the same virus. The content and sequences of amino acids are known for the proteins of many viruses. For example the protein subunit of TMV consist of 158 amino acids in a constant sequence with a mass of 17,600 dalton.

The protein subunits of TMV are arranged in a helix containing 16, 1/3 subunits per turn (49 subunits per three turns). Each TMV particle consists of approximately 130 helix turn of protein subunits. The nucliec acid is packed tightly between the helices of protein subunits. In rhabdovirus the helical nucleoproteins are enveloped in a membrane.

In polyhedral plant viruses the protein, subunits are tightly packed in arrangement that produce 20 facets and form a shell. In this shell the nucleic acid is folded or otherwise organized.

The nucleic acid of most plant viruses consists of RNA but about 80 viruses are known to contain DNA. Both nucleic acid either DNA or RNA are long chain like molecules consisting of hundreds/thousands of units called nucleotides. The size of both RNA and DNA is expressed either as Dalton or as the number of bases (Kb for ssRNA and DNA or kilobase pairs (Kbp) for double stranded RNA and DNA. Most plant viruses contain (540) ssRNA, but 40 contain dsRNA, 30 contain dsDNA and about 50 contain ssDNA.

SATELLITE VIRUS AND SATELLITE RNA

The satellite viruses are virus that must always be associated with certain typical viruses (helper viruses) because they depend upon the later for multiplication and plant infection. Satellite virus reduce the ability of the helper viruses to multiply and cause disease i.e. satellite virus act like parasites of the associated helper virus.

The satellite RNA are small, linear, circular RNAs found inside the virion of certain multi component viruses. Satellite RNA's are not related or only partially related to RNA of the virus. These satellite RNA's may increase or decrease the severiy of viral infections.

VIRUS INFECTION

Plant viruses enter cells only through wounds, made mechanically or by vectors, or by deposition into an ovule by an infected pollen grain.

When a plant is infected by virus, the virus moves from one cell to another and multiplies in most of the cells. Then the virus moves from cell to cell through plasmodesmata, connecting the adjacent cells. Viruses multiply in each parenchyma cells infected. In leaf parenchyma the virus moves approximately 1 mm or 8-10 cells/day.

Most viruses require 2-5 days to move out of an inoculated leaf. In all economically important viral infections virus reach the phloem and transport to long distance within the plant. Once the virus entered the phloem, it moves rapidly in it towards growing region like apical meristem and other food utilizing parts of the plant like tubers and rhizome.

The development of local lesion symptoms is an indication of the localization of the virus within the lesion area. In systemic symptom the virus continued to spread beyond the borders of the lesion.

In systemic virus infection some viruses are limited to phloem and a few adjacent parenchyma cells. Many virus leave the growing point of stems or roots of affected plants apparently free of virus but few virus invade all new meristem tip tissues.

It appears that the diseased condition induced in plants by viruses is the result of interference and disruption of normal metabolic processes in infected parenchyma or specialized cells. This interference is caused by the mere presence and multiplication of virus and possibly by the abnormal or toxic effects of additional virus-induced protein or their products (not found yet).

Plant virus do not contain any enzymes, toxins or other pathogenic substances and yet cause a variety of symptoms on host. Viral diseases of plant are not due primarily to depletion of nutrients but due to more indirect effects of virus on the metabolism of plant which is due to virus induced synthesis of new proteins by the host (like enzyme) and may interfere with the normal metabolism of the host.

Viral infection generally cause a decrease in photosynthesis through decrease in chlorophyll/leaf, chlorophyll efficiency and leaf area per plant. Virus generally cause a decrease in the amount of growth regulating substances in the plant frequently by increasing a growth inhibiting substances. There is a decrease in soluble nitrogen during rapid virus synthesis. A chronic decrease in the levels of carbohydrate is seen in the mosaic disease.

The respiration of plants is generally increased immediately after infection but after the initial increase the respiration of infected plants became lower than that of healthy plant.

SYMPTOMS

The symptoms of plant virus diseases are of major importance in the identification of the virus concerned. Most virus are named on the basis of chief symptom they produce on the host on which they were first reported. Symptomatology was very important in the early days of virus research before any of the viruses were isolated and characterized.

The external symptoms provide the first clue about possible viral infection but symptoms change under different environmental, nutritional and climatic conditions. They are also influenced by the type and strain of virus, type and variety of host plant, age and stage of development of virus and pathogens. Virus like symptoms may be caused by other plant pathogens like viroids, phytoplasma and fastidious bacteria.

The term symptoms refers to visible abnormalities in plants. These symptoms are in the form of colour changes of foliage or growth abnormalities. Mostly the hosts are affected systematically by the viruses and the virus persist in infected plants throughout life. Thus in vegetatively propagated plants the virus persist throughout life and the progenies are always virus infected.

When the infection remains confined near the site of virus entry, it is called local infection, but when infection spreads slowly to surrounding cells through plasmodesmata and phloem to long distance in host system is called systemic infection. The time period between the virus entry and first appearance of symptoms is called the incubation period.

The abnormality develop in all parts of infected plants, not only externally but internally as well.

External Symptoms

The external symptoms produced by virus infection is divided into two broad categories, those resulting due to infection of single inoculated cells of host plant and those which cause systemic infection where the virus moves from the site of initial infection to the entire plant.

(a) **Colour changes:** The word variegation refers to all types of colour changes on leaves. The mosaic symptom are characterized by mottled green (spot or blotches of colour) or patterns of green and yellow areas. When yellow colour is uniform and unbroken it is known as chlorosis. In graminaceous plants, the mosaic pattern may be in the form of streaks and stripes. Scorching of entire leaf or its margins is burnt appearance. In vein clearing the tissues close to the veins turn yellow and the remaining lamina surface stays green. In vein banding the tissue near the veins remain green and rest of the lamina surface turns yellow. Colour changes are accompanied by some structural changes of the organ. Pouch like development of green parts of leaves are called puckering. The drying of cell in a particular fashion leads to rings pots, black spots etc. The ring spot lesion consist of a central group of dead cells beyond this there develop one or more superficial concentric rings of dead cells with normal green tissue between them. Viruses producing ring spot type of symptoms are mostly transmitted by soil-living organism. Ring spot patterns may also occur on other organs for example bulbs and tubers.

(b) **Changes in growth pattern:** Leaf curl is a symptom in which leaves curl from the margins backward bringing the centre of the lamina upward. In leaf roll the margins roll inward froming a trough like shape with midrib in the centre of the trough. The leaves become thick and leathery due to accumulation of starch. Galls can be formed on leaves and other organs. In mosaic diseases leaves may be abnormally lobed with fern like appearance forming filiform or shoe-string structures.

Virus infected plants may show a wide range of developmental or growth abnor-

malities. Reduction in size of leaves and shoots is a common symptom in many virus diseases. When leaves are small they give a bushy appearance to the plant. Hypertrophy and hyperplasia results in bunched top or witches broom symptom. Stem sometimes show a spike like growth. Spindle tuber and spindle shoots are other growth abnormalities.

Some virus infections produce out growth or enations from the upper or lower surface of the leaves. These outgrowths are generally associated with vein of upper and lower surface. These enations may be due to abnormal cell proliferation, as a result of virus induced changes in hormone concentration. Wound tumor virus produces wart like outgrowths on the stems and roots of infected clover plants.

(c) **Symptom on stems and roots:** The major stem symptoms due to viral infection are seen in swollen stems in cacao infected with cacao swollen shoot disease. Tumors are produced on the stem of clover plants by wound tumor virus. In woody plants stem symptom appears as flaking, cracking, necrosis of bark and excessive gum formation, stem splitting and scar formation. The prominent symptom seen on roots are abnormal proliferation of rootlets, reduced number of adventitious roots. In legumes the N_2 fixation is reduced by virus infection.

(d) **Flower Symptoms:** In flowers the virus infection produces marked changes in colour. Colour breaking symptoms are very common in the flowers of many virus-infected plants. The breaking usually consists of flecks, streaks or sectors of tissue. The breaking of petal colour is due to loss of anthocyanin pigments. In a few instances there may be increased pigmentation in some areas of the petals. Infected flowers are frequently smaller and may drop prematurely. Flowers may be reduced in size, deformed in shape and quiet frequently flowering may be reduced. This effect the yield of viable seeds.

(e) **Abnormalities in fruits, seeds and pollen:** The viral infection show colour changes in the fruits. Fruits show mottling, ring, spotting and necrotic symptoms. Fruits may be distorted and misshapened. The texture of fruits can be changed like in cucumber the wart like projections develop due to cucumber mosaic virus infection. In tomato the fruits may be dwarfed, malformed and seedless due to tomato aspermy virus. Virus infection may have drastic effects on seed production like in wheat, soybean. Sometimes the seed produced are completely abortive. The pollen production and pollens from infected plants are frequently sterile or viability is reduced.

In *Musa* cultivars infected with Banana virus the fruit bunch emerges from the side of pseudo-stem in spite from the top of it.

Internal Symptoms

The external symptom induced by viruses are frequently reflected in anatomical and histological changes within the plant. Mesophyll cells are smaller and less differentiated with few or no intercellular spaces. The vascular bundle may enlarge. The chloroplast is reduced and as a result the tissue may become abnormally translucent. Large number of sieve elements in companion cells develop. Necrosis resulting from phloem may spread to other tissues also. The internal changes in virus affected plants can be observed by light and electron microscopy and include anatomical and histological deviation, cytological and ultra structural changes and formation of inclusion bodies.

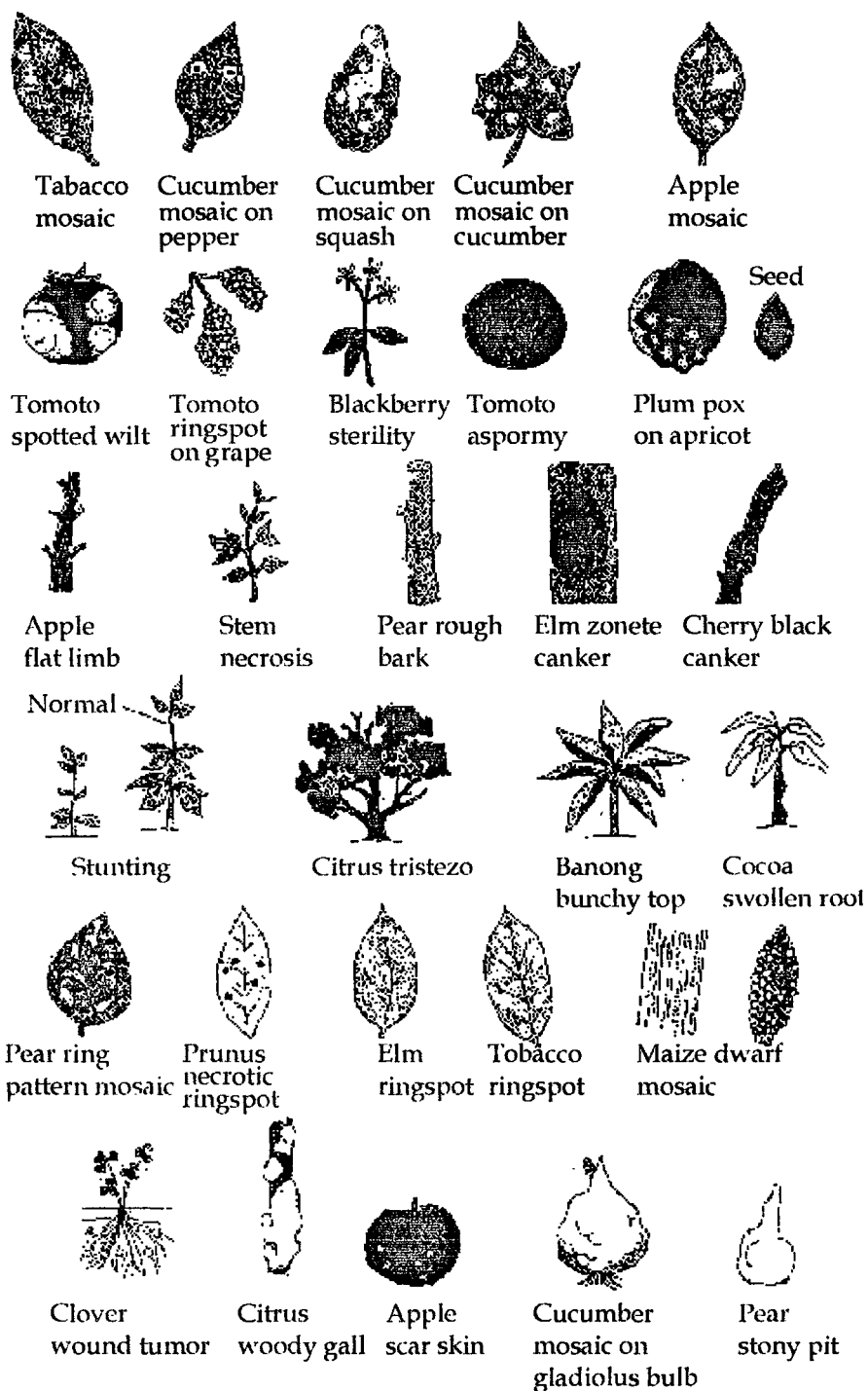

Fig. 1 : Symptoms of viral diseases of plants

(a) Anatomical and histological changes: In the infected host the anatomical changes are expected and do occur in one or two other form in the infected plant. These changes are reflected in the form of particular external symptoms. The cells may decrease in size (hypotrophy) or in number (hypoplasia), or may increase in size (hypertrophy) or in number (hyperplasia). Excessive hyperplasia leads to proliferation of tissues causing witches broom, bunchy top etc. The cells may under go necrosis or deviate in content like reduction of chloroplast causes chlorosis and nuclear swelling.

In leaves showing mosaic or yellowing symptom the palisade cell may be smaller with fewer chloroplast. The yellow areas have restricted growth which leads to buckling, puckering and blistering. Extreme hypertrophy of lamina give rise to shoe string leaves. Enlargments of cells adjacent to veins obliterates intercellular spaces and few chloroplasts are produced making the tissue translucent.

In anatomical changes the phloem may destroy (phloem necrosis) eg-potato leaf roll disease. In curly top of sugar beet there is hyperplasia resulting in death of phloem parenchyma. The abnormal meristematic activity of phloem parenchyma resulting to formation of tumors.

Stem pitting or wood pitting symptoms are caused by development of localized areas of disorganized parenchyma instead of xylem and phloem.

(b) Cytological and ultra structural changes: The main cell organelles influend by viruses appear to be nucleus, chloroplast and mitochondria. In some cases disintegration of cell organelles like ribosomes and endoplasmic reticulum may take place.

Nuclei: Many viruses show no detectable change on the nucleus but some may give rise to intranuclear inclusions of various sorts and may affect the nucleolus on the size and shape of the nucleus.

Nuclei texture become granular, chromatin may be reduced. Nucleoli become swollen or hypertrophied and disintegrated eg-Geminivirus. Some times the nuclei may become filled with virus particles and greatly enlarged. The perinuclear space may be filled with some Rhabdo-viruses. Crystalline plate like inclusions were observed in cells infected with tobacco etch virus.

Chloroplast: There may be structural and biochemical degeneration of chloroplasts. Small peripheral vesicles may be seen in the chloroplast. Chloroplast may be swollen, rounded and clumped together in the cell. Sometimes it become club shaped. There may be accumulation of starch grains and their size and number may be abnormal. The colour may be from normal green to colourless. Sometimes the chloroplast may be fragmented.

Mitochondria: There may be regeneration or aggregation of mitochondria in virus infected cells. Sometimes mitochondria may be filled with vesicles also.

Changes in cell wall: Due to virus infection the cell become abnormally thickened. There may be deposition of electron dense material between cell wall and plasma membrane. Callus deposition may also be induced with some virus infections, which may help in restricting virus movement.

Ribosomes: There may be disturbances in the ribosomes. These may disappear or

may become integrated with inclusion bodies. There may be proliferation of the plasma-lemma to produce vesicles.

Inclusions body: The major cytological effect of virus infection is development of inclusion bodies. Inclusion bodies are the intra cells structures produced *de novo* as a result of virus infection. Inclusion bodies may contain virus particles, virus related materials or ordinary cell constituents in a normal or degenerate conditions. These intracellular inclusions is of diagnostic value.

Matz (1919), Kunkel (1921), and Smith (1924) were among the first workers to observe these inclusions and for some time a controversy centred about their nature.

There are two main types of inclusions, crystalline and amorphorous (also known as X-bodies).

Inclusion bodies are most common in the epidermal cells of leaves and stems, but they also occur in the roots and flowers and in most tissues except the phloem sieve elements. (Bawden 1964).

McWhorter (1965) has tabulated the various types of intracellular inclusions as follows:

Group A—Amorphous inclusions only, crystalline inclusions absent. Eg—Amorphous spherules in wound tumour disease of *Rumex acetosa*.

Group B—Amorphous and crystalline inclusions. Crystal in cytoplasm seldom or never present in the nucleus. TMV in tobacco, red clover vein mosaic in *Vicia faba*.

Group C—Amorphous and crystalline inclusions; crystal present in both nuclei and cytoplasm. Tobacco etch virus in solonaceae.

Group D—Other entities unusual or only described in part in virus infected cells of the wild sunflowers.

X-bodies: The amorphous inclusion are called 'X-bodies' and resemble certain microorganism. They are amoeboid in shape and are virus induced structures in the cell where components of viruses are synthesized and assembled. Matsui (1959) divided X-bodies into two categories based upon their fine structures. One appears elliptical in outline and is almost entirely composed of dense granules varying in size, there is no envelope. The other usually appears spherical in outline and consists of a narrow peripheral zone and large internal vacuole.

Intraplasmic crystalline Inclusions: Intracellular inclusions seem to be associated only with rod shaped virus particles. No inclusion bodies have been described in connection with 'spherical' viruses although microcrystals of tomato bushy stunt virus have been observed in the cells of infected *Datura stramonium*.

Intranuclear inclusions: These inclusions are mainly in the form of thin plates, birefringent when seen from the edge. Their occurrence is sufficiently regular as to be of diagnostic value.

Intranuclear crystalline inclusions have been observed within leaves of *Vicia faba* or *Phaseolus vulgaris* infected with bean yellow mosaic virus. The inclusions occurred

frequently in groups in the nucleoplasm whereas they usually occurred singly within the nucleolus and were so large to distort it. The inclusions revealed a regular periodicity of striation within them. The cytoplasm also contained similar crystalline inclusions.

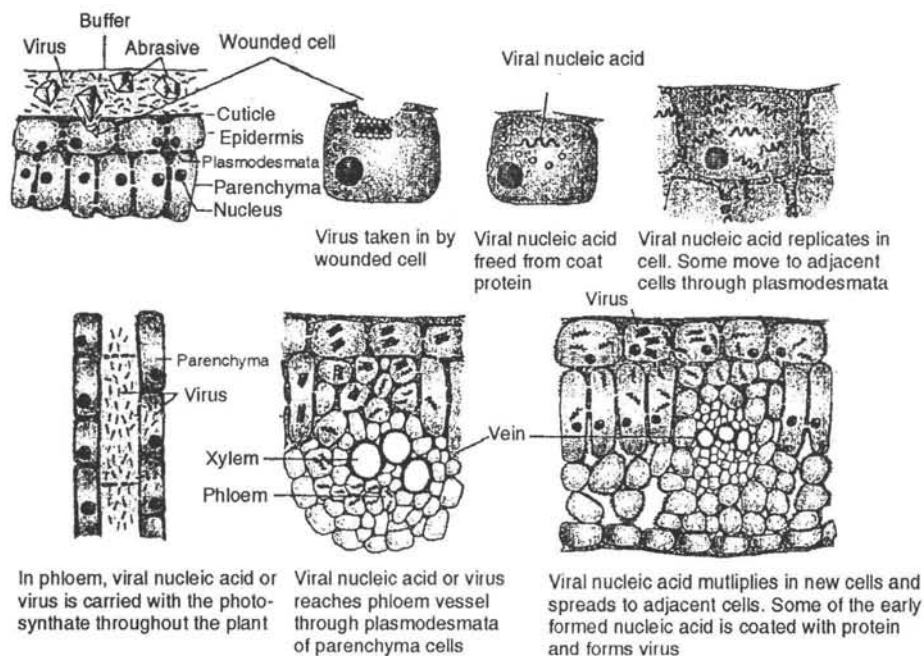

Fig. 2 : Mechanical inoculation and early stages of systemic spread of viruses in plants

Various kinds of rather peculiar inclusions, associated with virus infection can be placed in this category. There are the spindle bodies found in virus affected cacti, and the bizarre 'pin-wheels' and 'cat-O- nine tails'.

Presence of inclusions composed of vesicles and virus in some immature tracheary elements may indicate that virus multiplies in these cells. Complex membranous structures together with unbranched tubules containing single rows of virus-like particles have been observed in the case of strawberry latent ringspot virus and cow pea mosaic virus.

CLASSIFICATION & NOMENCLATURE

Most of the plant viruses are named after the most conspicuous symptom they cause on the first host in which they have been studied. Thus a virus causing mosaic on tobacco is called Tobacco mosaic virus, whereas the disease itself is called tobacco mosaic; another virus causing spotted wilt symptom on tomato is called tomato spotted wilt virus, and the disease is called tomato spotted wilt.

All viruses belong to kingdom viruses. Within the kingdom, viruses are distinguished as RNA viruses and DNA viruses depending upon whether the nucleic acid of virus

is RNA or DNA. These viruses are further divided depending upon whether they possess one or two strands of RNA or DNA of either positive or negative sense, either filamentous or isometric. Within each of these groups there may be viruses replicating via a polymerase enzyme (+ RNA or DNA virus) or via a reverse transcriptase (-RNA or DNA viruses). Most viruses consist of nucleic acid surrounded by coat protein, but some also have a membrane attached to them. Some viruses have all their genome in one particle (monopartite viruses) but the genome of other (multipartite) viruses is divided among two, three or rarely four particles. Other classification characteristics include the symmetry of helix in helical viruses or number and arrangement of protein subunits in the isometric viruses, size of virus and any other physical, chemical or biological properties.

The current nomenclature and classification scheme of plant viruses is as follows:-

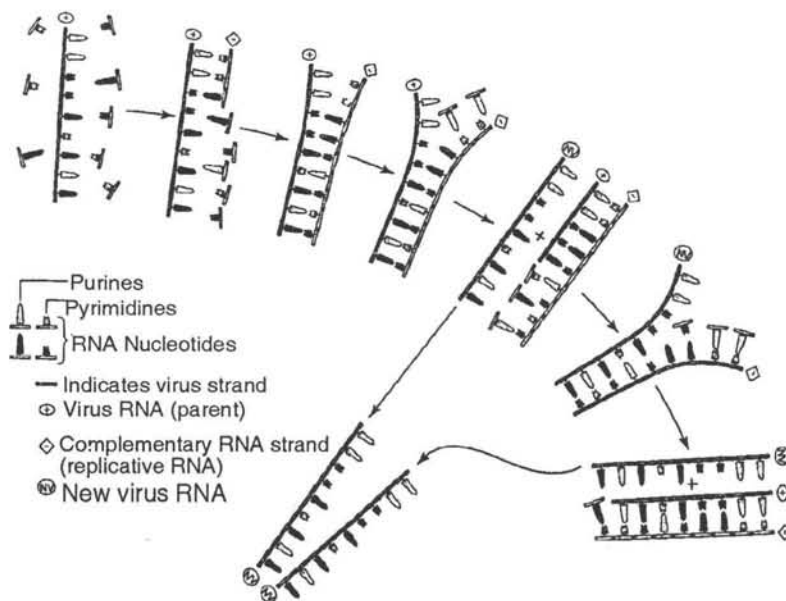

Fig. 3 : Schematic representation of viral RNA replication

KINGDOM : VIRUSES

RNA Viruses

Single-stranded positive RNA [(+) ssRNA]

Rod-shaped particles: c. 32 viruses

1. ssRNA

Genus: *Tobamovirus*. Example: *Tobacco mosaic virus* Remark: Contact transmission.

2. ssRNAs

Genus: *Tobravirus*. Example: *Tobacco rattle virus* Remark: Nematode transmission.

2-4 ssRNAs: Fungus- transmitted rod-shaped viruses

Genus: *Furovirus*. Example: *Soil-borne wheat mosaic virus* Remark: Fungal transmission.

3. ssRNAs

Genus: *Hordeivirus*. Example: *Barley stripe mosaic virus* Remark: Seed transmission.

Filamentous particles: c. 280 viruses

1. ssRNA

Genus: *Capillovirus*. Example: *Apple stem grooving virus* Remark: No vector some seed transmission.

Carlavirus. Example: *Carnation latent virus*

Trichovirus. Example: *Apple chlorotic leafspot virus*. Remark: No vector some seed transmission.

Potexvirus. Example: *Potato virus X* Remark: By contact only.

Family: *Potyviridae*-1 or 2 ssRNAs

Genus: *Potyvirus*. Example: *Potato virus Y* Remark: Aphids w/helper virus.

Rymovirus. Example: *Ryegrass mosaic virus*.

Bymovirus: Example: *Barley yellow mosaic virus*. Remark: Fungal transmission

1. ssRNA, long, flexuous filaments

Genus: *Closterovirus*. Example: *Beet yellows virus* Remark: Aphids, mealy bugs or white flies.

Isometric particles: c. 165 viruses

1. ssRNA (+)

Family: *Sequiviridae*

Genus: *Sequivirus*. Example: *Parsnip yellow fleck virus*. Remark: Aphids.

Waikavirus. Example: *Rice tungro spherical virus*. Remark: Leafhoppers or aphids.

Family: *Tombusviridae*

Genus: *Tombusvirus*. Example: *Tomato bushy stunt virus* Remark: Soil borne no vector known.

Carmovirus. Example: *Carnation mottle virus*

Genus: *Dianthovirus* example *Carnation ring spot virus* Remark: Soil borne.

Genus: *Machlomovirus*. Example: *Maize chlorotic mottle virus*. Remark: Seed, beetle, thrips.

Genus: *Necrovirus*. Example: *Tobacco necrosis virus*. Remark: Fungal transmission.

Genus: *Luteovirus*. Example: *Barley yellow dwarf virus*. Remark: Gramineae, aphids.

Genus: *Marafivirus*. Example: *Maize rayado fino virus*

Genus: *Sobemovirus*. Example: *Southern bean mosaic virus*.

Genus: *Tymovirus*. Example: *Turnip yellow mosaic virus*.

2. ssRNAs

Family: *Comoviridae*

Genus: *Comovirus*. Example: *Cowpea mosaic virus* Remark: Chrysomelid beetles.

Nepovirus. Example: *Tobacco ringspot virus*. Remark: Nematodes.

Fabavirus. Example: *Broad bean wilt virus*. Remark: Aphids.

Family: *Luteoviridae*

Genus: *Enamovirus*. Example: *Pea enation mosaic virus*. Remark: Mechanically, Aphids.

3. ssRNAs

Family: *Bromoviridae*

Genus: *Bromovirus*. Example: *Brome mosaic virus*. Remark: Beetles, mechanically.

Cucumovirus. Example: *Cucumber mosaic virus*. Remark: Aphids

Ilarvirus. Example: *Tobacco streak virus*. Remark: Pollen seed.

Alfavirus. Example: *Alfalfa mosaic virus*. Remark: Aphids

Single-stranded negative RNA [(-) ssRNA]: c. 90 viruses

1. (-) ssRNA

Family: *Rhabdoviridae*

Genus: *Cytorhabdovirus*. Example: *Lettuce necrotic yellows virus*. Remark: Leaf hoppers, plant hoppers. Aphids.

Family: *Phabdoviridae*

Nucleorhabdovirus. Example: *Potato yellow dwarf virus*. Remark: same

3. (-) ssRNAs

Family: *Bunyaviridae*

Genus: *Tospovirus*. Example: *Tomato spotted wilt virus*. Remark: Thrips

4 (-) ssRNAs

Peculiar particle morphology, sometimes folded, filamentous, 3-12 nm thick

Genus: *Tenuivirus*. Example: *Rice stripe virus* Remark: Plant hoppers

Double -stranded RNA (dsRNA)

Isometric viruses: c. 40 viruses

2. dsRNAs

Family: *Partitiviridae*

Genus: *Alphacryptovirus*. Example: *White clover cryptic virus I*. Remark: Nonenveloped, latent.

Betacryptovirus: Example: *White clover cryptic virus II*. Remark: Same, seed.

10-12 dsRNAs

Family: *Reoviridae*

Genus: *Fijivirus*. Example: *Rice Fiji disease virus*. Remark: Plant hoppers.

Oryzavirus. Example: *Rice ragged stunt virus*. Remark: Plant hoppers.

Phytoreovirus. Example: *Wound tumor virus*. Remark: Leaf hoppers.

DNA Viruses

Double-stranded DNA (dsDNA): c. 21 viruses

Family: *Caulimoviridae*

Isometric, circular dsDNA viruses

Genus: *Caulimovirus*. Example: *Cauliflower mosaic virus*. Remark: Aphids

Nonenveloped bacilliform particles

Genus: *Badnavirus*: Example: *Rice tungro bacilliform virus*. Remark: Mealy bugs.

Single-stranded DNA (ssDNA): c. 55 viruses

Geminate (twin) particles

Family: *Geminiviridae*

Genus: *Geminivirus*

Subgroup I: Monocotyledonous hosts, leafhoppers vectors, monopartite genome.

Genus: *Mastri virus*

Example: *Maize streak virus* Remark: Graminae, leaf hoppers.

Subgroup II: Dicotyledonous hosts, leafhoppers vectors, monopartite genome.

Genus: *Curtovirus*

Example: *Beet curly top virus* Remark: Dicot leaf hoppers.

Subgroup III: Dicotyledonous hosts, mostly whitefly vectors, bipartite genome.

Genus: *Begomovirus*

Example: *Bean golden mosaic virus*. Remark: DNAs, White flies.

Single isometric particles

Example: *Banana bunchy top virus*.

PHYSIOLOGY AND CYTOLOGY OF PLANTS INFECTED WITH VIRUSES

Virus infection in plants results in several biochemical changes which are consequently reflected in the form of disease symptoms. Most of the work is largely confined to estimation of alterations in various components like carbohydrates, sugars, phenolics, alkaloids growth regulators, nucleic acids. Important metabolic functions like photosynthesis, respiration and transpiration rates were also changed. Mostly the changes taking place in leaves have been studied, because they constitute most of the herbaceous host plant. The virus infection alters the water content of tissues and reduces the size of leaves.

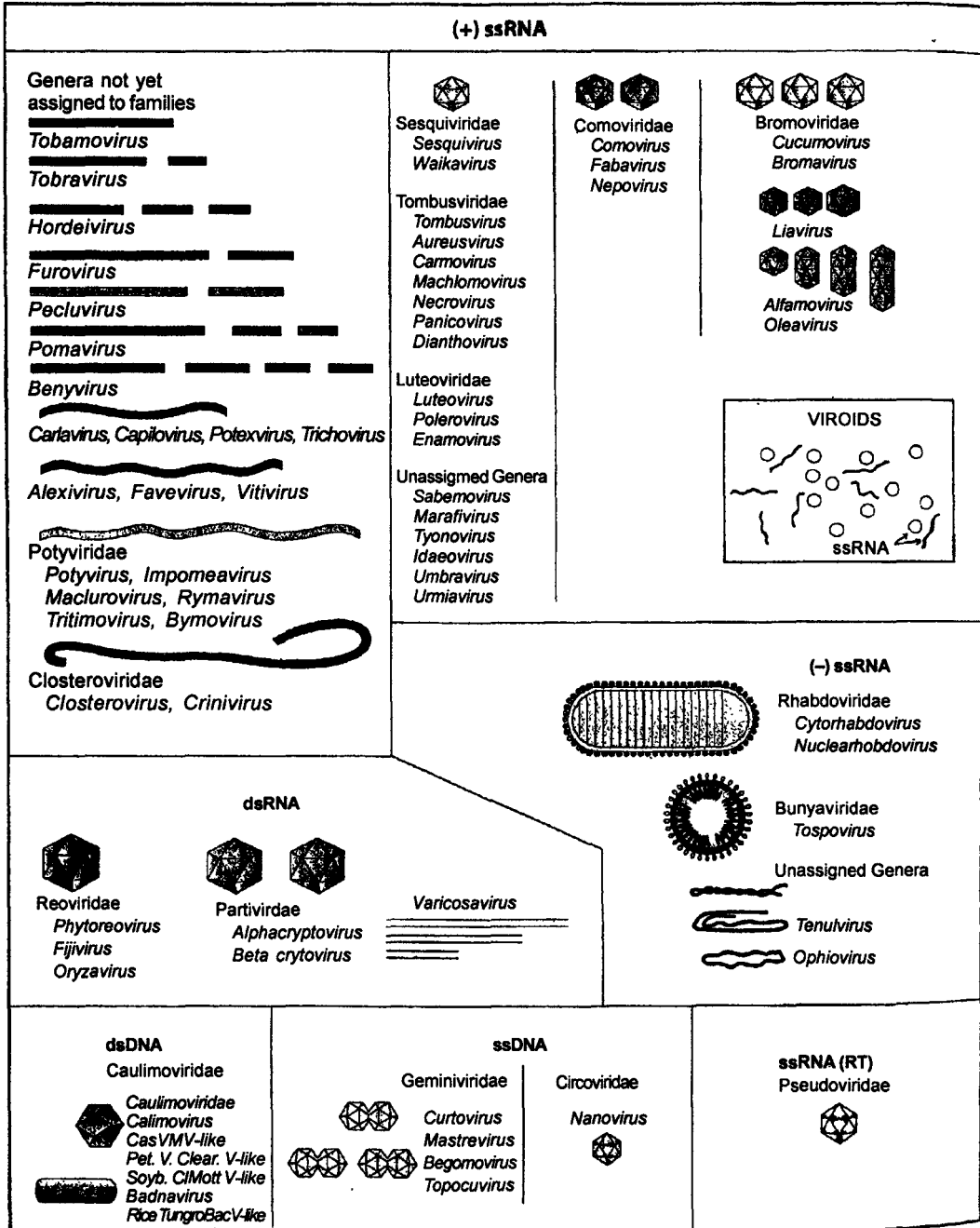

Fig. 4 : Schematic diagram of families and genera of viruses and viroids that infect plants

Respiration

In the past a great deal of work has been done on the respiration of virus-diseased plants. There are mostly reports of increase in respiration rate in mosaic diseased plants. But in some cases where disease is well developed respiration rate may be lower. In plants developing local lesions the respiration rate is always higher. Increased respiration may involve increase in the activity of some enzymes of glycolytic and pentose phosphate pathways. The results have been contradictory because various variable factors have not been taken into account.

Photosynthesis

Virus infection usually affects the process of photosynthesis. There is reduced carbon fixation due to virus infection which may be due to a variety of biochemical and physical changes and becomes detectable a few days after infection.

Chloroplast colour may change from normal green to colourless. There is a reduction in the number of grana and chlorophyll content. Photosynthetic activity can be changed or reduced due to change in chloroplast structure by reduced content of photosynthetic pigments or by reduction in specific proteins.

The biochemistry of photosynthesis and related pathways can be affected as a result of virus infection. There may be diversion of the products of photosynthesis carbon fixation. Instead of sugar formation there may be production of organic acid and amino acid. These changes, may be transitional and may return to normal pattern when active virus multiplication is over.

The most general effect of virus infection is a reduction in photosynthetic activity which is due to change in a variety of biochemical and physiological changes.

Transpiration

In severely infected plants, transpiration rate is generally reduced as compared to healthy plants. The reported effects over the first 1-2 weeks after inoculation vary.

Enzymes

Infection may affect enzyme activities through changes in the amount of enzyme inhibitors or activators released when cells are disrupted. Increase in catalase, peroxidase (enzyme or isoenzymes) and polyphenol oxidases has been reported for various host-virus combinations. There is a marked increase in the activity of nucleases enzyme which may be because of their direct involvement with virus synthesis. Increase in activity was also observed in acid phosphatase, aconitase and starch synthetase in different host-virus combination. However pentose phosphate isomerase and succinyl co-A synthetase activity was decreased following infection with TMV in tobacco plants. Virus infection can also affect the expression of host genes encoding enzymes.

Hormones

Virus infection influences hormone activities in infected plants and plant hormones.

Quantitative effects of infection on concentration have been shown for all the major groups of plant hormones. Systemic virus infections tend to impair the steady state auxin levels with consequent morphological alterations. Stunting in virus infected plants has been associated with a decrease in gibberellins. Change have been observed in reduced or increased cytokinins and abscisic acids.

The most affected plant growth regulator is ethylene which is associated with senescence in plants. Generally its production is increased in virus infection.

CHANGES IN LOW MOLECULAR WEIGHT METABOLITES

There are reports of accumulation of free amino acids in virus infected plants. An increase in amides (glutamine and asparagines) may be due two reasons: either due to the breakdown of host proteins or due to inhibition of normal protein synthesis as a result of which they are not properly utilized and accumulate in free form. However in many host virus combinations deficiency of both soluble and insoluble nitrogen compounds may occur during periods when virus is rapidly being synthesized.

Phosphorus is a vital component of all viruses and disturbances in phosphorus content is observed in virus infected plants. However there is no clear picture of the effect of virus infection on host phosphorus metabolism. Increase in organic acid synthesis during virus replication is reported. Some essential elements like Mn, Cu, Zn are highly reduced in virus infection whereas the infection has slight effect on K, Ca, Mg, Fe, B and Al. Reduction in specific mineral elements are associated with certain virus disease symptoms.

Virus infection causes loss of chlorophylls giving the yellowish colouration due to carotene and xanthophylls but these pigments are also decreased in some diseases. In some virus infections particularly characterized by dark green symptoms, there may be more chlorophyll than the uninoculated control plants.

Changes in nucleic acid: Virus infection has little effect on DNA content of host cell. However this infection affect differently with RNA synthesis in different host virus combinations. Chloroplast and cytoplasmic rRNA synthesis may be affected as a result of virus infection. This effect of infection may vary with age. The changes observed in young and old leaves significantly vary. A reduction in chloroplast ribosomes without a marked effect on cytoplasmic ribosomes is a fairly common feature for mosaic diseases.

Changes in Proteins: There is a substantial reduction in host protein synthesis (by 75%), when the virus is actively replicating in virus infection. During this period the host machinery is involved in the synthesis of viral proteins rather than host proteins. The coat protein of a virus (like TMV) can represent half of the total protein in the diseased leaf. A reduction in the amount of most abundant host protein ribulose biphosphate carboxyl oxygenase (RUBISCO) is one of the commonest effects of virus that cause mosaic and yellowing diseases.

Lipids: The lipid content of leaves infected with virus may be greater than healthy leaves or in few host-virus combinations it may be less.

Carbohydrates: Virus infection significantly influences the carbohydrate synthesis

as well as rate of translocation. There is a large accumulation of carbohydrate and sugars in virus-infected leaves as compared to healthy leaves.

In conclusion, Diener (1963) considers that the physiological derangements most commonly associated with plant virus infections are as follows: (i) decreased photosynthetic activity (ii) increased rate of respiration (iii) accumulation of soluble nitrogen compounds, particularly amides; (iv) increased activity of polyphenol oxidase and accumulation of oxidized polyphenol derivatives. (v) decreased activity of growth regulating substances.

Viral Diseases of Tomato

The first record of virus diseases of tomato in India seems to be by Likhite in 1930. The leaf curl of tomato was described in 1948. Sastry and Singh (1971, 1974a), Sastry *et al.* (1976) and Singh *et al.*, (1973) have made detailed study of relationship between vector, vector control, and incidence of tomato leaf curl. Viral diseases causes severe losses on all fresh market and canning tomatoes.

LEAF CURL OF TOMATO

The disease has been reported from India, Sri Lanka, Nyasaland (Malawi) and South Africa. Leaf curl disease incidence is reported to be 83% in the winter crop planted in October and 14% in the summer crop planted in February (Tripathi and Varma, 2002). When the plants are infected within 20 days of transplanting the loss may be up to 92% while infections of 35 and 50 days old crops result in 74 and 29% loss, respectively.

Symptoms

Leaf curl is characterized by severe stunting of the plants due to shortening of internodes and downward rolling and crinkling of the leaves. The newly formed leaves show chlorosis. The older curled leaves become leathery and brittle. After the plant becomes infected there is considerable drop of flowers, fruit fails to set, and no more marketable fruit is produced. The whole plant looks pale and produces more lateral branches resulting in a bushy appearance. There is partial or complete sterility of the plant.

The Causal Organism

Leaf curl of tomato is caused by the *Tobacco leaf curl virus* (geminivirus group or family Geminiviridae, genus *Begomovirus*). Its synonyms are Tobacco cabbaging virus, tobacco curly leaf virus and tobacco frenching virus. The genome of geminiviruses is composed of circular, single stranded DNA, encapsulated by multiple subunits of a single capsid protein. Most are bipartite having two almost equal sized genomic components designated A and B, separately encapsulated in geminate particles (Poiston *et al.* 1997). The Indian isolates from New Delhi and Karnataka have been separately named such as Tomato leaf curl New Delhi virus (ToLCNdV), a bipartite strain, and Tomato leaf curl Bangalore virus (ToLCBV), a monopartite strain. Chakraborty *et al* (2003) have described tomato leaf curl Gujarat virus (ToLCGV) from Varanasi in India which causes a severe leaf curl disease of tomato.

Disease Cycle

The geminate particles of the leaf curl virus (ToLCV) measure 25-30 × 15-20 nm. The ToLCV is neither seed nor sap transmissible but external contamination of seed may occur. Dodder transmission has been reported in India. The main agency of its transmission in nature is the whitefly, *Bemisia tabaci*. TYLCV is a whitefly transmitted geminivirus genome consists of a single circular SSDNA the genome of the other known whitefly transmitted goes viruses consists of two ssDNA. The vector can transmit the virus after a 20-minute acquisition access period and 60 min of inoculation access period with minimum latency period of 4-9 hours. In India, the virus is reported to be transmitted by the vector after 30 minutes of acquisition access and 30 min of inoculation access periods with a latency period of 6 hours. Even a single viruliferous whitefly is able to transmit the virus. The virus is retained by the vector for more than 12 days or for the whole life but there is no evidence that it multiplies in the vector or is transferred to the progeny of the vector. The time required for symptom expression varies in different cultivars of tomato. Whitefly populations per plant also vary with host cultivar. The number of whiteflies per plant has no relationship with the time of appearance or severity of symptoms. At low temperatures symptoms are delayed.

Control and Treatment

Resistance to the virus in commonly cultivated tomato varieties is lacking. Wild tomato (*Lycopersicon peruvianum*) has high degree of resistance to the leaf curl virus. *L. glandulosum* also does not show symptoms of leaf curl. Some accessions of the wild species *Lycopersicon hirsutum* have been identified as the best source of resistance to tomato leaf curl virus as well as tomato yellow leaf curl virus. In Punjab, the genotypes TLB 111, 119, 122, 128, 129, 130 and 134 have been found resistant to ToLCV.

Protection of seedlings from infection brought by the vectors is important. It can be achieved by using insecticides or insect repellents. Tripathi and Verma (2002) have demonstrated that seedlings protected by perforated polythene bags and transplanted in polysheet mulched fields have low incidence of the disease. Some workers have claimed good control of the disease through reducing vector population. Use of systemic insecticides such as methyl parathion (0.02%) and dimethoate (0.5%) as spray of carbofuran (1.5 kg a.i./ha) as soil application has been found effective in controlling build up of whitefly population and thus reducing the incidence of leaf curl. Spraying should be started soon after transplanting. Carbofuran (Furadon 3G) at the rate of 3.3g/sq.m. not only reduces disease incidence but also increases fruit yield. Nursery treatment, seedling soak, and plot treatments reduce populations of *Bemisia tabaci* and diseases incidence. Sastry et al (1976) suggested increased plant population from 30 to 90 per sq.m., three applications of insecticides (parathion 0.02%, demetonmethyl 0.02% or dimethoate 0.05%) as spray at 15-days interval with one soil application of phorate or carbofuran for control of the disease. Foliar application of the antibiotics Validomycin-A (0.02%), Avomycin-A (0.01%) and of guanidine azoguanine, etc. suppress the disease. Mukherjee and Raychaudhuri (1966) had reported that the root dip of tomato seedlings in gibberellic acid and 2-thiouracil at 50 pp, reduces leaf curl incidence. Spraying of 2,4-D is highly effective

in not only suppressing tomato leaf curl incidence but also in many-fold increase of fruit yield.

In some countries like Israel, because of TYLCV, tomatoes are now produced only under fine mesh and frequent application of insecticides. Considerable efforts are presently being made to genetically engineer tomato plants to express certain genomic areas of TYLCV that seem to protect the plant from subsequent infection by the virus.

MOSAIC OF TOMATO

Tomato mosaic can be caused by many different viruses such as TMV, *Cucumber mosaic virus* (CMV), *Potato virus X*, and *Potato virus Y*. The common tomato mosaic was earlier thought to be the same as TMV but now it is considered to be a distinct virus (ToMV) of the same tobamovirus group.

Symptoms

The symptoms of tomato mosaic are generally influenced by temperature, day length, light intensity, plant age, virus strain, and tomato variety. In the tropics or in warm weather with long day length and high light intensity leaves show light and dark green mosaic mottle, sometimes with distortion of young leaves. Green areas are sunken giving the leaf a rough appearance. In winter, with low light intensity, short day length, and temperature not above 20°C, plants often are severely stunted and leaves distorted to "fern-leaf" or tendril-shape but mottling may be slight. Seedling infection may kill the plants. Fruits are fewer, undersized, and often deformed. In some cases there is necrosis of stem, petioles, leaves and fruits.

In aucuba mosaic the symptoms appear as downward curling of the whole leaf with slight turning down at the margins. Surface of the leaf is rough, wrinkled or corrugated. Chlorosis appears as small points of yellow areas and gradually spreads. In extreme cases almost the entire lamina of old and new leaves becomes pale yellow to white, with scattered small islands of green which stand up as blisters. In less extreme cases the green areas are larger but not as large as the chlorotic areas. The plant is not killed but growth is retarded. The virus induces pollen sterility which results in low fruiting and low yield.

The Causal Organism

The virus causing the common mosaic of tomato is known as *Tomato mosaic virus* (ToMV, tobamovirus group). There are many strains of the virus producing different symptoms and often these have been described as different diseases. These strains are tomato aucuba mosaic, tomato enation mosaic, yellow rings spot strain and tomato rosetted strain.

Particles of the virus are straight tubules with helical construction and measure 300 x 18 nm. The single stranded RNA constitutes about 5% of the particle weight. The particles occur in all the tissues including the pollen and seed but not in the embryo. The inclusion bodies appear as crystalline structures, amorphous masses, fine needles, fibrous spikes, spindle bodies, and amoeboid X-bodies.

Disease Cycle

In tomato sap the thermal inactivation point is 85-90°C, dilution end point is 1:100000 to 1:1000000. In air-dried tomato leaves the virus has been found to remain infective even after 24 years at laboratory temperatures. The sap retains infectivity for 77 days or more at laboratory temperatures and for several years at 0° to 2°C. The virus, like the TMV, is easily sap transmissible and is mainly transmitted by man through contact during cultivation. No natural vector are known. Seed transmission also occurs mainly as external seed contamination. TMV and ToMV become established in the seeds of tomato and bell pepper, irrespective of plant growth stage, at the time of inoculation. However, concentration of the virus is high in seeds from plants inoculated early. Dodder can transmit the virus. Diseased crop debris is also a source of primary inoculum.

Control

Use of virus-free seedlings is the most important step for control of tomato mosaic. To produce healthy seedlings the seedbeds should be those in which no solanaceous crop susceptible to TMV had been grown for the last 4-6 months. Soil sterilization by heat is also recommended. Seeds should be treated in hot water at 50°C for 25 min or with 20% trisodium phosphate solution. There should be an interval of at least 5 months between susceptible crops in the same field. Field workers should avoid use of tobacco products while working in the field. If they remove a diseased plant they should wash their hands in soap solution.

RICE TUNGRO VIRUSES

Tungro is the most important virus disease of rice in south and south-east Asia and also in the southern part of China. The virus is reported from Philippines, Malaysia, Indonesia, Thailand, India and Pakistan. In India the disease is present in the south east to the north west parts of the country. The annual loss due to tungro is estimated at US \$ 1.5 billion globally.

Symptoms

In rice the symptoms depend on host cultivar. In the cultivar TN 1, seedlings show stunting with mottling and yellowing of leaves. In growing plants there is reduced tillering. Yellowing and orange yellow coloration of leaves is a common symptom. Small and sterile panicles develop in mature plants. In early infection the young plants may die prematurely.

The Causal Organism

Tungro is a composite disease caused by two viruses: the rice tungro spherical virus (RTSV) and the rice tungro bacilliform virus (RTBV). The RTSV is a ssRNA virus which causes only very mild stunting of the host plants without leaf symptoms but it intensifies the symptoms of tungro caused by RTBV. The RTBV is a dsDNA bacilliform virus which causes mild stunting and yellowing of leaves. RTBV causes the main symptoms of tungro. It is dependent on RTSV for transmission by the insect vectors. In Philippines and South

and South East Asia the RTSV occurs and spreads as an independent virus but generally as a latent disease.

RTSV is associated with maize chlorotic dwarf virus group. The particles of RTSV are isometric with a diameter of 30-33 nm. The ssRNA is in single piece (monopartite) and constitutes 12% of the particle weight. The RTSV RNA consists of about 11 kb, and its protein coat is made of two types of protein molecules. The RTBV belongs to Budnavirus group. The particles are bacilliform, 100-400 nm long and 30-35 nm in diameter. Both viruses are transmitted by same leafhopper vectors. The thermal inactivation point of RTSV is 60°C. The longevity *in vitro* at room temperature is 24 hours, one week at 4°C and one month in frozen samples. In the host cells dense granules are seen in the cytoplasm. Chloroplasts and other cell organelles in the infected tissues are degenerated.

Disease Cycle

Oryza species are the main host but at least 63 species of grasses could be infected. Natural occurrence on grasses in and around rice fields is reported. However, all except *Oryza* species are poor hosts of the vectors.

The rice tungro viruses are not transmitted by sap inoculation or by seed or dodder. In nature the main agency of tungro transmission is the green leafhopper, *Nephotettix cincticeps* (*N. virescens*). Other vectors are *N. nigropictus*, *N. malayanus*, *N. parvus*, *N. apicalis* and *Recilia (Anazuma) dorsalis*. *N. cincticeps* is the most effective vector and disperses the virus in the rice fields. All the five larval stages and adults of the leafhopper vector transmit the viruses in non-persistent manner. There is strong biological relationship of the vector with rice plants on which it has high adult longevity, nymph survival and population growth. Minimum acquisition feed period is 5-7 min but transmission increases with acquisition access feeding upto 4 days. There is no latency. The vector becomes viruliferous immediately after feeding. Nymphs cease to transmit the virus when they molt. All stages lose ability to transmit the virus within 5 days after the end of the acquisition feed. Weed hosts that may play a role in survival and dissemination of the rice tungro viruses include *Leersia hexandra*, *Eleusine indica*, *Echinochloa crusgalli*, *Echinochloa glabrescens*, *E. colona* and *Leptochloa chinensis*.

N. cincticeps is monophagous to rice. Its density can reach high levels depending on the environment. After rice is harvested, the density of this vector falls rapidly to a low level or to nil in the rice fields. Seasonal pattern of immigration and population dynamics of the major vectors (*N. cincticeps*, *N. nigropictus* and *Recilia dorsalis*) determines the incidence of tungro. Under Assam conditions, Nath and Bhagabati (2002) observed that leafhopper populations are first seen during June-July in the seedbeds. The population reaches the peak in the main field in October-November and then disappears from December to May. *N. virescens* populations were lower than *N. nigropictus* but higher than *R. dorsalis*. Tungro infected plants including rice stubbles or volunteer rice serve as source of RTBV and RTSV. The vector that feeds on source plants, moves to newly transplanted fields in surrounding areas and disperses the viruses. Probably the flight range of *N. cincticeps* is several kilometers. Initially few plants are infected and form the source for further spread. Generally, the plants with secondary infection from such sources form

patches a few to several meters in diameter. Such patches later fuse with each other. In tungro-endemic areas major infection of rice plants with the viruses occurs after transplanting. Infection rate in the seedbeds is low. In transplanted fields, infection with RTSV alone precedes infection with RTBV. The disease incidence is generally low in fields planted in the early crop season when the vector population is low, but it is high in fields planted later when the vector population has built up.

Control

Use of rice cultivars resistant to tungro has been a major approach for control of the disease. The resistance to the viruses is correlated with resistance to the vectors. The resistant cultivars become susceptible in few years because populations of the vector develops that can feed on these cultivars. A transgenic *japonica* rice plant is reported that contains RTSV replicase gene. Plants expressing full length Rep gene in the (+) sense orientation show 100% resistance to RTSV even if challenged with a high level of inoculum. The rice cultivar Basmati 370 is reported to be resistant. In many countries long fallow periods reduce the disease incidence.

Plant extracts have been used to reduce the population of the vector and disease severity. Metabolites of the rice false smut fungus, *Claviceps oryzae sativae*, are reported to provide tolerance in rice to the tungro disease. Neem seed cake applied at 5 kg/0.032 ha of nursery followed by foliar spray of 5% neem kernel extract in the main field reduces vector population and incidence of tungro. Two fungi, *Beauveria bassiana* and *Paecilomyces amoeneroseus*, are reported as parasites of rice green leaf hopper, *Nephotettix virescens*. Spray of conidial suspension of the fungi on rice plants kills the vectors.

SUGARCANE MOSAIC

Mosaic is most widely distributed and best known of the virus diseases of sugarcane. It was initially reported from Java in 1892 but now it is known to be of worldwide occurrence being common in India, North and South Americas, and many Pacific and Atlantic islands. The occurrence of sugarcane mosaic in India was first discovered in 1921 at Pusa (Bihar). Although a source of potential danger to sugar industry in countries like the USA, the disease has not been regarded as menace to sugarcane in this country. Even a 100% mosaic affected crop shows a reduction of about 10-12% in yield and the juice quality remains unaffected. Perhaps, it is due to prevalence of some mild strain(s) of the virus occurring in most of the sugarcane varieties in India. There are indications that more virulent strains are also present in the country on certain varieties like Co. 313 in Punjab and Co. 527. The disease may cause as much as 21% loss in yield.

Symptoms

The first symptom of sugarcane mosaic appear about 6 weeks after planting and continue to develop throughout the monsoon season after which they are obliterated on maturity of the plants. The primary and critical symptom of the disease is the appearance of pale patches or blotches in the green surface of the leaf. Small areas of the leaf are of a paler green colour than the rest. These patches are not uniform in size and shape.

They may be large in some varieties and small in others. Usually they are oval or elongated, the longer axis lying parallel to the midrib. In other parts of the world, the patches on sugarcane leaf are not confined between veins but in India there is a clear demarcation of these patches by the leaf veins. The youngest unfolded leaves show the mottling very clearly while the symptoms are not very clear on older leaves. Sometimes leaves of young tillers are stiff, erect and crinkled. Mottling of the stem also occurs in some varieties and may lead to death of cells resulting in formation of cankers.

The cells of affected leaves always show, in one part of the cytoplasm, an area of proteolysis. This can be seen under microscope as a more heavily stained area than the rest and consisting of a vacuolated mass representing the X-body. Stems may show mottling or marbling, the areas later becoming necrotic. The stems become small and deformed.

The Causal Organism

Sugarcane mosaic virus (750 × 11nm) is transmitted primarily vegetatively in sugarcane during propagation of the crop. The disease is caused by sugarcane mosaic virus (SCMV) which belongs to potyviruses group. Its synonym is grass mosaic virus. The particles of the virus are flexuous filaments measuring 620-750 × 13-15 nm. Maximum concentration of virus particles is found in young leaves and minimum in roots of old infected plants. Particle composition is not fully known. In addition to sugarcane, the virus can infect other graminaceous plants such as maize, sorghum, millets, wheat, barley, rye, and some grasses. Natural occurrence of the virus on maize, sorghum, pearl millet and elephant grass has been reported from India. *Brachiaria* is also a natural host of some strains of SMV. One strain that attacks *Musa textilis* has some hosts outside the gramineae.

The following serologically related potyviruses were considered strain of the *Sugarcane mosaic virus*. Sugarcane mosaic strains A, B, C, D, E, F, G, H, J, K (these strains rarely infect sorghum), Maize dwarf mosaic strain A and B, *Sorghum red stripe* strain, *European maize mosaic* strain and *Abaca mosaic* strain on *Musa textilis*.

Disease Cycle

The virus is transmitted from sugarcane to sugarcane by at least 7 species of aphids such as *Dactynotus ambrosiae*, *Hysteroneura setariae*, *Rhopalosiphum maidis*, *Toxoptera graminum*, *R. maidis* and *Shizaphis graminum* are reported as vectors of sugarcane mosaic virus in India. Transmission is in the non-persistent manner. Seed transmission is reported only for maize dwarf mosaic strain. Vegetative propagation is the main source of primary infection in sugarcane.

The thermal inactivation point of SCMV is 53-55°C and dilution end point 1:1000. In vitro longevity is 2-24 hours.

For experimental purposes the virus can easily be transmitted by introducing it into the actively growing tissues. Young leaves are most suitable for testing. Most common method is to use a needle to puncture the tissue over which infected juice has been spread or infected leaf has been wrapped. SCMV moves from the point of inoculation to young

leaves, roots and tillers and eventually to leaves that had emerged prior to inoculation. The pattern of SCMV distribution in moderately resistant and susceptible cultivars is not much different. However, the virus moves more slowly in the moderately resistant than in the susceptible cultivar.

Control

Due to continuous evolution of strains of the virus, its presence on grass or cultivated collateral hosts and long growing season of the sugarcane crop, resistant varieties are not permanent solution of the mosaic problem. Following practices have been recommended to minimize its incidence.

1. Use of selected healthy setts for seed.
2. Heat therapy (hot water or hot air) is effective against certain strains and can be used for raising disease-free nurseries.
3. Systematic rouging of the infected canes if the incidence is not very high.
4. Elimination of grass hosts.
5. Use of resistant or tolerant varieties.

ALGAL VIRUSES-THE CYANOPHAGES

Cyanophages are the viruses that attack on cyanobacteria i.e. the members of blue green algae. The first actual demonstration of an algal virus was made by Safferman & Morris (1963) from the waste stabilization pond of Indiana University (USA). They isolated the virus from the filamentous blue-green alga *Plectonema boryanum*. Safferman and morris tested 78 algal species For susceptibility to the virus and of these the virus lysed 11 filamentous strains. Among the genera infected were *Lyngbya*, *Plectonema* and *Phormidium*. The first algal virus was named as strain LPP-I, the initials representing these three hosts. There after several serological strains of LPP were isolated and named LPP-I LPP-2, LPP-3, LPP-4 and LPP-5. These viruses are called as blue green algal viruses or cyanophages. They screened 78 host organisms and found the cyanophages only in 11 filamentous cyanobacteria.

After the initial discovery several workers including Singh *et al* from Banaras Hindu University, India and Padan *et al* (1967) from Israel, Daft *et al* (1970) from Scotland reviewed different type of cyanophages.

Properties of Cyanophages

(1) The morphology of LPP-I is studied in more detail as compared to other cyanophages. They differ, morphologically as well as in their physio chemical properties.

(2) They are an icosahedron with a hexagonal head capsid and the tail is short with a length of approximately one quarter the diameter of the capsid (similar to T₃ and T₇ bacteriophages) where as N-I group resembles with T₂ and T₄ phages (like T even, the tail may be contractile or non-contractile). According to Smith *et al.* (1966b) the tail assembly is longer in virus particles attached to the photosynthetic membranes.

(3) According to Goldstein & Bendet (1967) LPP-I has double stranded DNA and can be concentrated by acetone without significant loss in activity.

(4) The AS-I group has the largest cyanophages. The group G III and D-I are serologically related but not show any relationship with T-phages.

Life Cycle

Similar like bacteriophages the cyanophages follow the same one-step growth curve. The growth cycle resembles with that of T_4 phages.

The first sign of infection in the alga can be readily recognized under optical microscope by displacement of photosynthetic membranes. The actual infection of the alga can be observed on the electron microscope. Large number of virus particles can be seen with their tails inserted in the alga.

The growth cycle of LPP-I has been studied in greater detail. LPP- I is adsorbed on host surface and the DNA is injected into the host cell leaving the protein coat outside the cell wall. The mechanism of DNA injection is not known. However soon after injection of the genome the rate of protein synthesis is reduced and gradually blocked at the end of 5 hour of injection. The phage multiplies in the invaginated photosynthetic lamellae or in virogenic stroma. After injection following three types of proteins are formed earliest proteins, earlier protein and the late or structural proteins. After three hours of infection, degradation of the host DNA begins and by the end of 7th hr it is converted into acid soluble material. Sufficient amount of degraded DNA material is used up in building of viral DNA. It is seen that in virogenic stroma synthesis of viral DNA takes place. The latent period differs in different viruses for example 7 hrs in LPP-I and N -I. At the end after maturation and assembly the progeny cyanophages are released almost from each cell leaving aside the lysed cell.

All nucleic acids of cyanophages analysed so far are linear double stranded DNAs. The cyanophages can play a significant role in control of blooms. But the problem is that, they are specific to genus and difficult to isolate.

Other Algal Viruses

Adolph and Haselkorn (1971), described a virus that attacks *Nostoc*, it has a long contractile tail which differentiates it from LPP-I and known as N-I. A virus similar to N-I with a polyhedral head and a long tail, attacks only unicellular blue-green algae.

A presumed virus attacking *Oscillatoria* closely resembles TMV; it is a slender rod about 190\AA in diameter and 3000\AA in length. It aggregate to form crystalline granules. Lee (1971) described a virus from a algae (*Sirodotia*) it occurs in crystalline arrays of polygonal particles each about $500\text{-}600\text{\AA}$ in diameter.

A virus has been isolated from a green alga, *Oedogonium* which occur in the germling stages of the alga and is hexagonal in transverse section with a maximum dimension of about 2400\AA .

A virus, resembling the *Tipula* iridescent virus has been found in a marine species. The brown alga, *Chorda tomentosa*, which is about 1,700 A° in diameter and possess a core of electron dense material enclosed by three-layered electron dense shell. The spores infected with virus particle was unable to develop cell wall, possibly their synthesis is inhibited by the virus.

TABLE 1
Various Groups of Cyanophages

Cyanophages	Sources	Host
G-III Group		
Long tailed	Polluted water, B.H.U.,	<i>Plectonema borryanum</i> India by R.N. Singh (1967)
Unnamed	Stream, Japan	<i>Oscillatoria princeps</i>
D-1	Scotland	Same as LPP-1
N-Group		
C-1	Polluted water, B.H.U.,	<i>Cylindrospermum</i> sp.
AR-1	Do	<i>Anabaenopsis circulans</i> , <i>Raphidiopsis indica</i>
N-1	Do	<i>Nostoc muscorum</i>
SM-Group		
SM-1	Waste stabilization ponds Indiana, USA	<i>Synechococcus elongatus</i> and <i>Microcystis aeruginosa</i>
SM-2	Fresh water	Do
AS-1	Polluted water	<i>Anacystis nidulans</i> and <i>Synechococcus cedrorum</i>
AS-1 M	Do	Do, also <i>M. aeruginosa</i>

TABLE 2
Physico-chemical and Morphological Characteristics of Some Cyanophages

Characters	LPP 1	LPP 2	N 1	SM 1	AS 1
1. Morphology	Icosahedral	Icosahedral	Icosahedral	Icosahedral	Hexagonal
2. Tail, size (nm)	Short 20x15	Short 20x15	Long 110x10	Absent —	Long 243x22
3. Nature of tail	Non- contractile	Non- contractile	Contractile	Absent	Contractile
4. Head diam (A°)	586	573	550	880	900
5. Class	C	C	A	C	A

Contd...

...Contd.

Characters	LPP 1	LPP 2	N 1	SM 1	AS 1
6. Relationship with coliphage	T3-T7	T7	T2, T4	T7	P1, P2
7. DNA mol wt. (Daltons)	27 x 10 ⁶	-	38 x 10 ⁶	56-62 x 10 ⁶	-
8. G+C Content(%)	53	-	37	66-67	53-54
9. Sedimentation coefficient (S)	526-550S	490S	539S	820S	254S
10. Buoyant density in CsCl ₂ (g/cm ³)	1.71 at 25°C	1.48	1.498	1.72 at 25°C	1.49
11. Mg requirement	+(1mM)	+(1mM)	+	-	-
12. Stability					
(i) pH range	5-11	5-11	-	5-11	4-10
(ii) Temperature	4-40°C	4-40°C	-	4-40°C	-
(iii) Temp for inactivation	35°C	55°C	-	55°C	55°C
13. Growth					
(i) Latent period (h)	7	6	7	32 min.	8
(ii) lytic period (h)	14	14	14	48	12
14. Burst size (pfu/cell)	200-350	200-300	100	100	50

FUNGAL VIRUSES-THE MYCOPHAGES

The viruses associated with fungi are called mycophages. They are wide spread in all taxonomic groups of fungi. Indeed over 70 species representing all the main taxonomic groups of fungi have been involved (Hollings, 1975).

For the first time Hollings (1962) gave the conclusive evidence of viruses that infected the cultivated mushrooms. *Agaricus bisporus* causing die back disease. The common symptom of mushroom virus disease are the loss of crop and the degeneration of mycelium in the compost. At least 5000 fungal sps are known to contain mycoviruses. Most of the species of *Penicillium* and *Aspergillus* have been found to be infected with viruses.

Ecologically the mycophages appears to be intracellular, a life style for which they are well fitted.

Characteristics of Mycophages

At present only few mycoviruses have been characterized and they are only the virus

like particles (VLPs) from the partially purified extracts from the fungus in electron micrograph of then section slides.

Five viruses have been isolated from mushrooms in Britain and they are known as mushroom viruses 1, 2, 3, 4 and 5. Virus 3 is bacilliform (19 × 50 nm) while the other four are isometric virus (virus 1 = 25 nm, virus 2 = 29 nm, virus 4 = 35 nm while the virus 5 appears to be spherical in shape measuring 50 nm. (Hollings and Spire 1972).

The mycoviruses have a heterogenous properties with a diameter (25-50 nm) and particle weight from 6-13 × 10⁶ dalton. They possess 1-8 segments of dsRNA with a molecular weight of 2-8.5 × 10⁶ dalton. All the known samples had only a single capsid protein but of varying molecular weight from 25-130 × 10³ dalton in different viruses.

Transmission of mushroom viruses is by infected spores and by anastomosis of infected mycelium with healthy mycelium. Infected spores have a thinner wall than do healthy spores and germinate more quickly. Transmission by spores is so efficient that no other vector is necessary.

Dark (1979, 80) reviewed the replication of mycoviruses inside the host (the fungal cell). He reported the host cell enzymes capable of transcribing the ssRNA and dsRNA *in vitro* and probably dsRNA *in vivo*. Highly specific virus coded RNA polymerase are necessary for effective *in vivo* transcription and replication of dsRNA. Such polymerase has been demonstrated in a number of dsRNA mycoviruses. According to Buck, probably the polymerase remain confined within the virus particle during the replicative cycle of mycoviruses.

Examples of Mycophages

(i) Mushroom (*Agaricus bisporus*) viruses

Hollings & Spire (1972) recorded at least six viruses and VLP from cultivated mushrooms, *A. bisporus*. The mycoviruses occur in a mixture of cells and are extremely hard to separate. The number of spores in a suspension necessary to infect a tray is about ten. These viruses can cause water lodged stipes, or dry brown and leathery mushrooms, or grey stunted clumps of dwarfed mushrooms that decay without further development or thick short stalked mushrooms with poorly developed caps or long thin stalked mushrooms.

In recent years, there has been many reports of normal yield and mycelial growth from virus infected mushroom crops suggesting that mycoviruses are not pathogenic (Hollings, 1982). One of the possible reason may be due to, the suppression of virus replication and due to production of a mycotoxin (patulin) in several species of *Penicillium* and *Aspergillus*.

A number of virus have been isolated from different sps of *Penicillium* viz. *P. stoloniferum* and *P. funiculosum* are infected with viruses containing double stranded RNA.

(ii) Virus on other fungal sps.

Ferault *et al.* (1971) isolated two types of virus particles from the spores of *Piricularia oryzae*.

Several different virus like particles have been isolated from *Sclerotium cepivorum* which is pathogenic to onions. Morphologically they are isometric, icosahedron.

Virus isolated from *Ophiobolus graminis* is a small isometric particles measuring about 29 nm in diameter. There are records of viruses and virus like particles from various species of *Puccinia*. Lecoq *et al.* (1974) describe a virus particle 34 nm in diameter with a sedimentation constant of 174S from *Puccinia striiformis*, *P. mulvacearune* and *P. suavaeolens*. Virus like particles have been found in axenic cultures of *Puccinia graminis*. They are isometric.

Due to the presence of mycoviruses in pathogenic fungi, the virulence of pathogens gradually declines resulting in even death of fungi. Fungal isolates of take all of cereals (caused by *Gaeumannomyces graminis*) containing only one kind of VLP's are mostly more pathogenic than virus free isolate. Along with this a highly pathogenic isolate of *G. gramenis* from wheat roots gradually lost the virulence over a period of 17 months in culture.

Since viruses have been isolated from a number of plant pathogenic fungi, the possibility of using viruses for the biological control of these fungi is a question of importance.

Taxonomic Position

Taxonomically, no serological relationship have been detected between any mycovirus and morphologically similar viruses in higher plants. Similarly no mycoviruses is been demonstrated to infect higher plants. The members of international committee for virus taxonomy set a large taxonomic group to accommodate all dsRNA mycoviruses. Two such groups has now been designated.

- (i) The *Penicillium chrysogenum* virus group.
- (ii) The *Penicillium stoloniferum* virus -S (PsV-S) group.

The member viruses within each of these groups are serologically related.

TABLE 3

Taxonomic Affinity of Mycoviruses with other Viruses of Plants or Animals

Mycovirus particles	Affinity with other viruses	Example
Rod-shaped particles	(i) Tobamovirus type	<i>Peziza ostracoderma</i>
	(ii) Uncertain affinity	<i>Lentinus edodes</i>
		<i>Mycogone perinisa</i>
		<i>Armillaria mellea</i>
Filament particles	Potexvirus type	<i>Boletus edulis</i>
Isometric particles	Herpes virus type	<i>Thraustochytrium</i> sp
		<i>Phytophthora infestans</i>
Bacilliform particles	Alfalfa mosaic type	<i>Agaricus bisporus</i>

Most of the plant viruses contain RNA as genetic material. Majority of them contain rod shaped ssRNA. Plant viruses or reoviridae contain dsRNA as genetic material e.g. wound tumour virus, cauliflower mosaic virus contain dsDNA as their genetic material.

TMV (TOBACCO MOSAIC VIRUS)

Tobacco mosaic is a serious disease of tobacco and tomato and causes serious losses to tobacco and tomato and some other crop plants. It is world wide in distribution which affects more than 150 genera mostly herbaceous (dicots), many vegetables, ornamental flowers and weeds. It is the most resistant virus known so far of which the thermal death point is 90°C for 10 minutes. TMV was the first virus that was crystallized by Stanley in 1935 from USA.

Pathogen causes the damage on leaves, flowers, fruits and causes stunting in plants. The general symptom are chlorosis, curling, mottling, dwarfing, distortion and blistering of leaves. TMV damages the solonaceous plant. After infection the common symptom is appearance of irregular dark green and light green areas on the leaves (patchy pattern of discoloured areas). The dark green areas are thicker and appears elevated, blister like over the thinner, chlorotic light green areas. Slight downward curling and distortion of leaves can also be seen. The leaves become narrow and elongated rather than oval shaped.

Mottling of older leaves with or without malformations of the leaflets is produced when the disease affects tomato. Leaflets become long and pointed and sometimes shoestring like. The virus reduces the yield as well as quality of products i.e. nicotine content is decreased by 20-30%.

Franklin *et al.* (1957) described the structure of TMV. It is rod shaped helical virus, 280 x 150 µm with a molecular weight of 39 x 10⁶ dalton. The virion consist of protein coat, made up of 2,130 protein subunit of identical size. The protein subunits are arranged around a central hole of 4 nm (40Å°). Each protein subunit is made up of single polypeptide chain made by 158 amino acids, the molecule weight of each polypeptide chain is 17,500 dalton. The central/hole consist of ssRNA molecule which is also spirally coiled to form helix. This RNA consist of 6,500 nucleotides. In one turn of RNA contain 49 nucleotides.

Total number of protein subunits counting in 3 turns is 49 i.e. 49/3 unit/turn. Therefore single protein subunit is linked with 3 nucleotides TMV is an excellent immunogen. There are 3-5 different epitopes distributed over the surface of TMV protein. The two epitopes located on C-terminal and N-terminal extremities of polypeptide chain are responsible for stimulating the production of antibodies.

Takeba (1975) demonstrated direct entry of TMV into the isolated protoplast from mesophyll cells of tobacco. After entry the genetic material (RNA) rapidly starts uncoating by removing the subunits from the capsid by using the host cell enzyme. The parent RNA is localized in nucleus which do two functions, it acts as mRNA and direct the synthesis of protein and also function as template for the synthesis of complementary strand.

The virus RNA utilizes the amino acids, ribosomes and tRNA of the host and synthesize the complementary strand and proteins, i.e. coat proteins of 17,500 dalton and

two other polypeptide (of molecule weight 160,000 and 140,000 dalton). Nucleic acid is about 5-40% of virus and proteins 60-70%.

TMV is transmitted through cell sap of host and enters a new host through wound incision. It is also transmitted by wind and water.

Cryptogram of TMV = R/1 : 2/5 : E/E : S/O.

CAMV (CAULIFLOWER MOSAIC VIRUS)

CaMV causes cauliflower mosaic on cauliflower. This is the plant virus where dsDNA, open circular is the genetic material with single strand discontinuity like hepadna virus. *In situ* the DNA is linear but becomes circularized when extracted.

Single virion has icosahedral symmetry of the capsid with 50 nm diameter. In infected cauliflower leaves the cytoplasm has characteristic X bodies which are rounded structure.

Finger like projection arises from the cell walls of infected leaves. The mitochondria and nuclei of infected cells become abnormal and the transmission of pathogen is by aphids.

Cryptogram of Camv D/2 : 5/15: S/S: S/AP.

POTATO VIRUS X (PVX)

PVX virus is distributed worldwide containing ssRNA as genetic material. There are several strains of PVX developing different symptoms on different varieties of potato. A large number of solonaceous plants like tobacco, datura, *Solanum nigrum*, egg plants, pepper, tomato etc can be infected by PVX. The infected tubers of potato transmit the virus particles which can remain alive about 5 months but can be inactivated at 74°C.

PVX virus is also called as *Solanum virus*, potato latent virus, mottle virus. The infected potato shows a wild mosaic between the veins on foliage. The infected plants become dwarf and deformity in foliage occurs. The virus also causes top necrosis in tubers.

Structurally PVX is a flexous rod in helical symmetry dimension ranging from 515 x 11.2 nm capsid is made up of identical proteins subunit forming a helix of 3.3 nm, pitch and a hole of 3 nm diameter. Possibly a single subunit is associated with 3 or 4 nucleotides. In India the PVX was first isolated in 1945 by Vasudeva and Lal.

PVX spreads through rubbing, contact of plants and tubers, seed cutting, knife, farm implements, clothing and animal fur. In stores it can spread by sprout contact also. In nature a wide range of PVX-infected plant species including weeds (*Dahlia*, *Solanum* sps) serve as the source of virus infection.

Transmission is through sap. It spreads through contact between the healthy and diseased plant, core grafting and dodder. However it perennates in the diseased seed stocks. Average tuber infection varies from 13-23%. PVX causes 10-30% yield loss. But the combined effect of PVX and PVY causes severe disease and reduce yield loss drastically.

TRANSMISSION OF PLANT VIRUSES

Plant viruses are obligate parasites and to survive they must be spread from one susceptible host plant to another like other disease causing agents. The property of transmissibility is a fundamental characteristic of virus also. For years the transmission of virus provided the only experimental evidence of its existence as an independent entity. The spread of virus or transmission of virus occurs in the following ways:-

- (i) Mechanical transmission
- (ii) Vegetative and graft transmission
- (iii) Dodder transmission
- (iv) Pollen and seed transmission
- (v) Nematode and fungal transmission
- (vi) Insect transmission

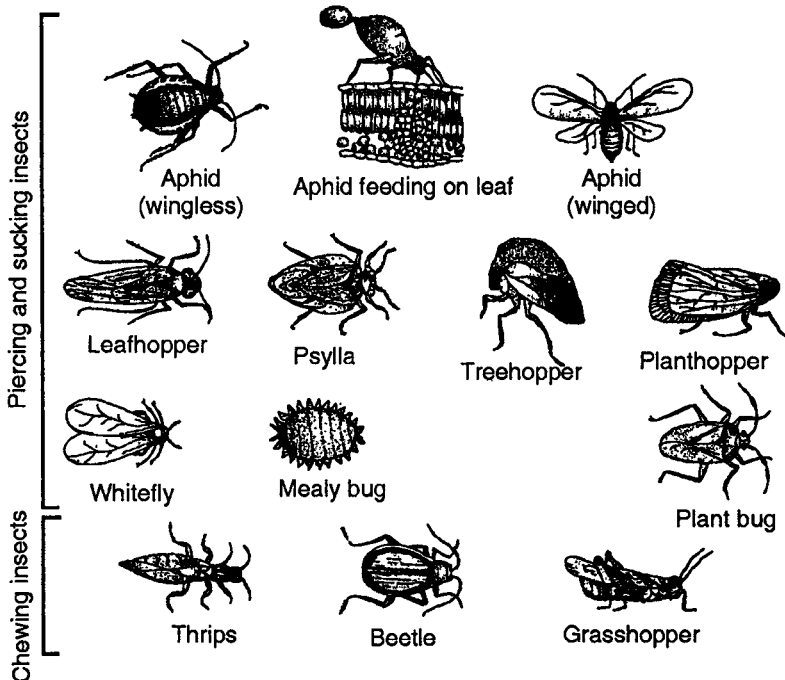

Fig. 5 : Insect vectors of plant viruses

The organism who transport the virus from one plant to another is called vectors. They introduce virus into plant tissues. Transmission by vectors also involves some biological interaction between vector and virus. Plant virus generally do not cause infection unless they come in contact with the contents of a wounded living cells. Virus cannot penetrate the intact plant cuticle or cellulosic cell wall. This problem is overcome either by avoiding the need to penetrate the intact outer surface (i.e. seed transmission or by vegetative propagation) or by mechanical or insect transmission.

Transmission of Plant viruses

Mechanical	Vegetative & graft	Dodder	Pollen & seed	Fungal & Nematode	Insect
<p>(1) by contact of leaves.</p> <p>(2) by action of animals (fox rabbit).</p> <p>(3) by action of humans (tools or mechanical devices) clothing by cutting knives during pruning.</p> <p>(4) Rare and probably of minor economic importance.</p> <p>(5) Experimental by using an abrasive such as carborundum powder (edgy particles with silicon carbide crystals)</p> <p>(6) Its success depends upon.</p> <p>(a) virus purity.</p> <p>(b) pH and ionic strength of inoculum.</p> <p>(c) Age.</p> <p>(d) Physiological condition of host many viruses are not mechanically transmitted because they inactivate.</p> <p>- Requirement of specific cells beneath epidermis. Can be by dilution of sap. Grinding at high pH or in nicotine. Oxidase activity can be overcome by adding sodium sulphite or EDTA. Nuclease activity is avoided by adding bentonite clay or by using alkaline buffer it also increase the absorption of virus to cell membrane.</p> <p>- Addition of sucrose help in promoting virus uncoating process.</p>	<p>1. Systemic infected plant, cutting, tubers corms, bulbs, rhizomes will always contain virus.</p> <p>2. Care should be taken not to propagate dahlia, carnations, chrysanthemum from diseased plant.</p>	<p>1. Experimentally useful method.</p> <p>2. Occur in the member of covalvulaceae.</p> <p>3. Haustoria connect with vascular tissue of host through phloem of dodder plant. CMV and tobacco rattle virus replicate in dodder</p>	<p>1. Seed borne disease ex-legumes, cowpeamosaic, cucurbits, cucumber, mosaic, tobacco rattle, tomato mosaic tomato ring spot.</p> <p>2. Mostly + nt in embryo, endosperm or non embryo portion (seed coat).</p> <p>3. Help in long distances transmission, when virus bearing pollen from diseased individuals bring about infection of ovule bearing plants the virus is said to be pollen transmitted and pollen borne. Ex-barley stripe, tobacco ring spot, bean common mosaic.</p>	<p>1. Fungi parasitize the root of many plants and zoospores of these fungi carry the virus on their surface or internally.</p> <p>2. New plant infected by infected zoospores and transmit the virus. Member of chytridiales and plasmodiophorates like <i>Olpidium brassicae</i>, <i>Polymyxa graminis</i>, <i>Spongospora subterranean</i>, <i>Synchytrium endobioticum</i> acquire virus from virus infected plant and are endoparasites of higher plants.</p> <p>3. Virus containing resting spores persist in soil for months to years.</p> <p>1. Nematode transmission Hewilt <i>et al</i> (1958) demonstrated that fan leaf virus of grapes is transmitted by nematode <i>Xiphinema</i>, <i>Longidorus</i>, <i>Trichodorus</i>, <i>Paratrichodorus</i> First two nematodes are deep feeders latter two feed superficially and less destructive.</p> <p>2. They acquire virus for short acquisition feed but remain viruliferous for long.</p> <p>3. There is virus vector specificity.</p> <p>Nepovirus- transmitted by longidoroids (<i>Xiphinema longidorus</i>).</p> <p>Netuviruses or tobraviruses. (<i>Trichodorus Paratrichodorus</i>).</p>	<p>1. Majority of invertebrate mobile vectors.</p> <p>2. Insect pierce the cell and feed on the sap of plants on which they feed.</p> <p>3. Later these viruliferous insects feed on healthy plants belong to Arthropoda or Nematoda. Mainly insects constitute the largest group of Arthropod vectors the non insect groups are mites.</p>

Virus show vector specificity
Virus can be divided into 3 groups (on the vector)

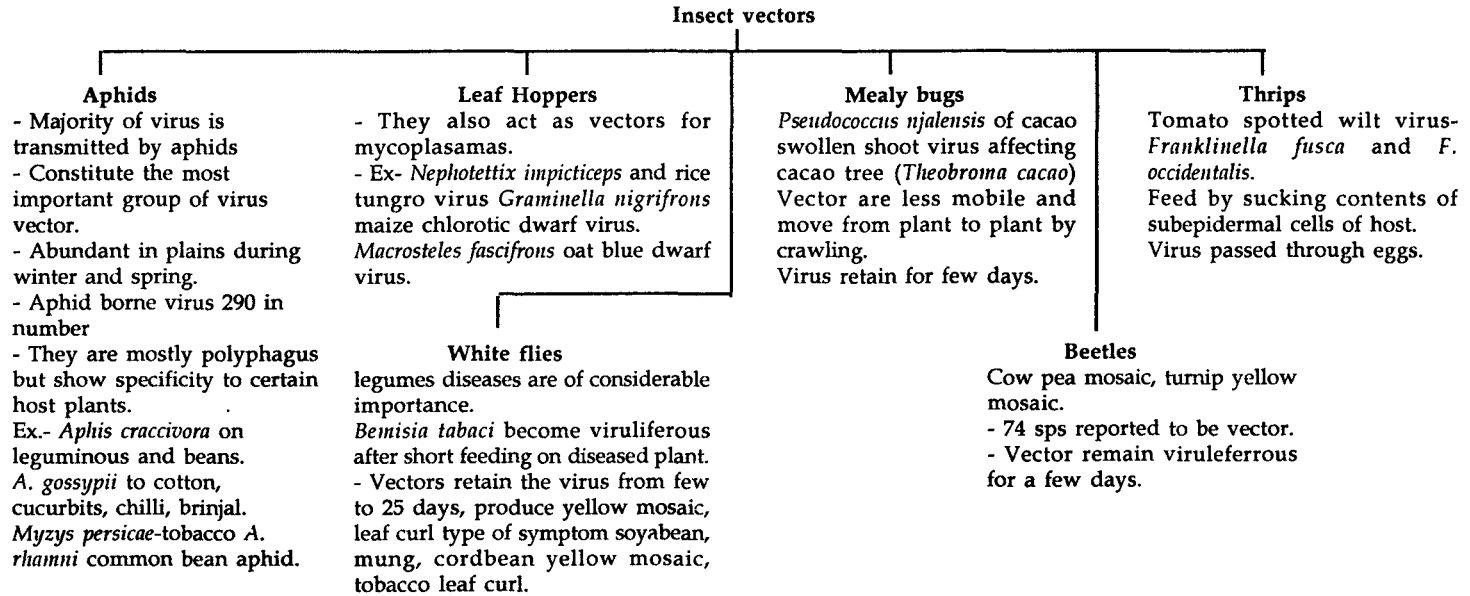

Virus can be divided into 3 groups (on the basis of their survival duration on vector)

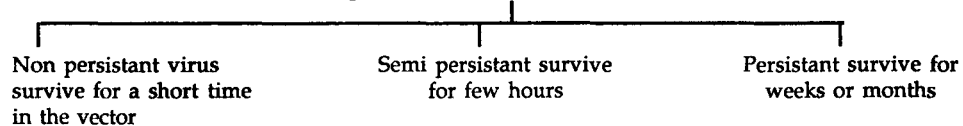

THE ANIMAL VIRUSES

Animal viruses are important because they affect several domestic animals of economic importance. In humans the viral disease are known since the ancient times in India and china for example Small pox, Influenza, and common cold. Viral disease like small pox was linked to super natural causes and people used to perform offerings to goddess, 'Shitala' throughout the country assuming that shitala had incarnated in the sufferers. Animal viruses have the same type of components as plant and bacterial viruses. They have the virion or the virus particle made up of the viral capsid which is made up of protein containing inside nucleic acid either DNA or RNA. The virus architecture is of two types helical (rod shaped, cylindrical) or icosahedral (spherical, quasispherical). For example the adenovirus is icosahedral, where as rabies virus is bullet shaped. Unlike plant and bacterial viruses the animal pathogenic virus contain an extra envelop outside the protein coat. This envelope is generally derived from the host cell membrane, but modified by insertion of virally encoded glycoproteins and removal of host membrane protein during virus maturation. These enveloped viruses are sensitive to drying and treatment with acid and detergent. They must remain wet to retain membrane integrity and therefore must be transmitted through blood, body fluids, respiratory droplets. The progeny particles of enveloped viruses are released from the host cell by budding. Non-enveloped viruses are released by the lysis of the host cell. They are resistant to drying and treatment with acid and alcohol.

REPLICATION OF ANIMAL VIRUSES

The replication of animal viruses differ from phages in mechanism of entering the host cell (because they are eukaryotic and other is prokaryotic in nature). The steps in the process of reproduction is:

- (i) Adsorption/Attachment.
- (ii) Penetration.

- (a) Direct penetration.
- (b) Fusion with plasma membrane.
- (c) Endocytosis.
- (iii) Uncoating.
- (iv) Replication of viral nuclei acids.
- (v) Assembly of virus particles and Release of virus particle.

1. Adsorption/Attachment

The virus particles get absorbed to the plasma membrane of the host cells by binding to specific sites where the receptor proteins (usually glycoproteins) are situated. The presence of these receptor proteins is crucial in the viral infection and it may determine host resistance or susceptibility. The receptor proteins are usually surface proteins necessary for the host cell, as these proteins are also receptors for hormones and other important molecules which get into the cell and are essential to the cell's function. The virus mimics these essential molecules and manages to get into the cell by endocytosis. Many host receptor proteins are related to immunoglobulins. For example HIV CD4 receptor, and the polio ICAM (intercellular adhesion molecule) receptor. In some cases two or more cell receptors may be involved. The surface site on the viral particle will be an array of specific proteins. Envelope glycoproteins may also be involved in adsorption in enveloped viruses. The herpes simplex virus has two glycoproteins that are involved in adsorption. In adenoviruses, the projections extending from the corners of the capsid play a role in binding to host cell receptors. Spikes of some enveloped viruses also play similar roles (myxovirus). For example, the influenza virus has two kinds of spikes, haemagglutinin, and neuraminidase. The haemagglutinin (H spike) attach to the host cell receptor site and recognize sialic acid (N-acetyl neuraminic acid). The N spike (Neuraminidase) helps the virus in penetrating the nasal and respiratory tract secretions by degrading mucosal polysaccharides. However the receptor sites vary from person to person.

2. Penetration and Uncoating

(a) and (b) Direct penetration or fusion with plasma membrane

Some non-enveloped viruses such as the polio virus, undergo changes in capsid structure on adsorption to the plasma membrane, and release only their nucleic acids into the host cell. In the paramyxoviruses, and some other enveloped viruses, the capsids fuse with host cell plasma membrane. Fusion occurs between the envelope glycoproteins and the host plasma membrane proteins. Then the membrane lipids rearrange forming a proteinaceous fusion pore. The nucleocapsid enters the host cell where uncoating take place.

(c) Endocytosis

Enveloped viruses may enter the host cell in another way. The virions attach to specialized regions on the membrane coated on the cytoplasmic side with protein clathrin. The coated regions pinch off to form coated vesicles filled with virus particles. The vesicles

fuse with lysosomes after the coating is removed. The lysosomal enzymes help in the uncoating process.

3. Uncoating

This is a process of separation of viral nucleic acid from the protein coat. This process is not fully understood. In some viruses the coating is done by lysosomal enzymes of the host cell which degrade protein coat and make the nucleic acid free in cytoplasm. In Pox virus the viral DNA synthesizes a specific protein after infection. Thus it varies with virus groups.

4. (i) Replication of DNA Viruses

The genes which express early are the ones which are meant to execute host cell arrest. The virulent animal viruses arrest all the functions of the host cell such as DNA, RNA and protein synthesis. The virus DNA replication usually takes place in the host nucleus using host DNA polymerase-II, except in the poxviruses (such as vaccinia) whose genomes replicate in the cytoplasm. In most viruses, early transcription occurs using host enzymes (polymerases) except in poxvirus where early mRNA is transcribed by a viral polymerase.

The genome of some viruses are too small to have enough genes for their replication (e.g., Parvoviruses). The Parvovirus has the genome to code for three polypeptides which are components of the capsid. The DNA of the virus is single stranded and linear. The DNA being very small has to replicate in the host nucleus during the host DNA replication using the host DNA polymerases. This virus is usually associated with adenovirus and called adeno-associated virus. Replication along with the adenovirus will help the virus to replicate in a dependent way.

Hepatitis-B virus (a member of Hepadnavirus group) is an enveloped virus with an incomplete dsDNA genome. It has a genome replication strategy similar to that of the retroviruses. Its genome is first completed and circularized in the cytoplasm, and transported to the nucleus. In the nucleus, the mRNAs are transcribed. Nucleocapsid is assembled in the cytoplasm along with virally coded reverse transcriptase. The DNA is synthesized inside the virion by reverse transcribing RNA copies of the genome.

Herpesviruses are dsDNA viruses with icosahedral enveloped virions causing important human and animal diseases. The genome contains 50-100 genes. Upon uncoating, the DNA is transcribed by the host RNA polymerase to form mRNAs to direct the synthesis of early proteins, the enzymes required for DNA replication, DNA replication takes place in the nucleus with the formation of virus-specific DNA polymerase. Host DNA synthesis slows down.

Poxviruses (e.g., vaccinia) are the largest animal viruses known and are also most complex. The double-stranded DNA contains around 200 genes. The virus enters through endocytosis in coated vesicles. The central core of the virus contains DNA and DNA dependent RNA polymerase that synthesizes the early mRNAs. DNA polymerases and other enzymes needed for the DNA replication are also synthesized in the early part of the reproductive cycle, DNA replication begins about 1.5 hours after infection. After DNA

replication late mRNA transcription begins. Many late proteins are structural proteins used in capsid formation. The complete reproductive cycle takes about 24 hours.

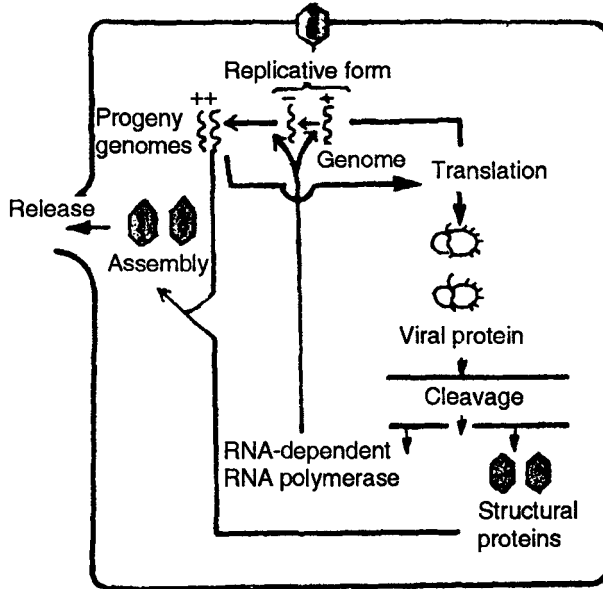

Fig. 1 : Replication of positive single-stranded RNA viruses

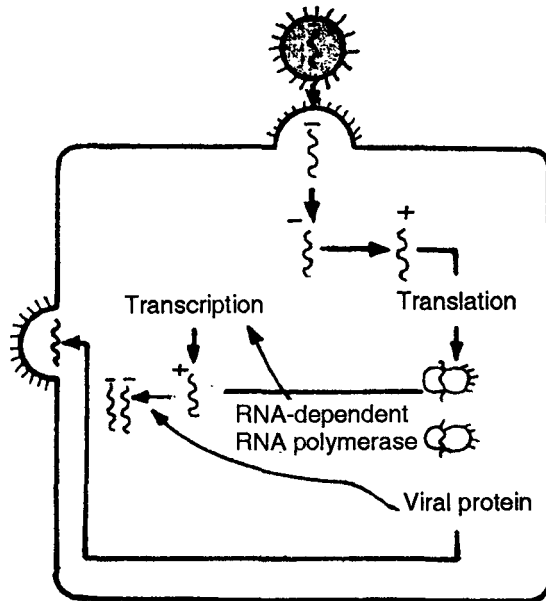

Fig. 2 : Replication of negative single-stranded RNA viruses

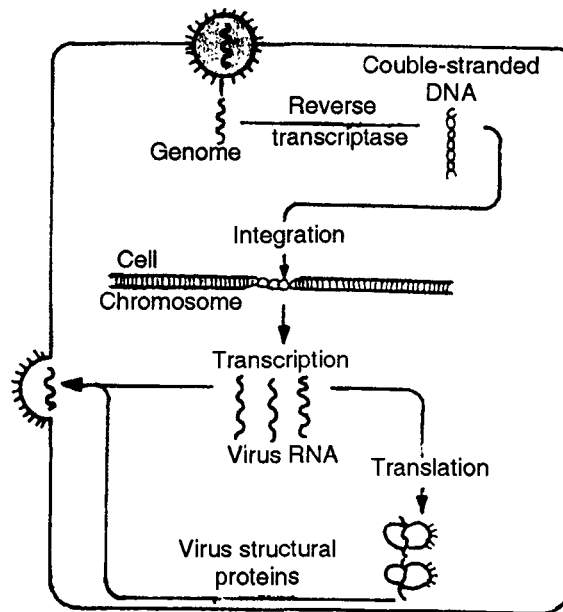

Fig. 3 : Replication of retroviruses

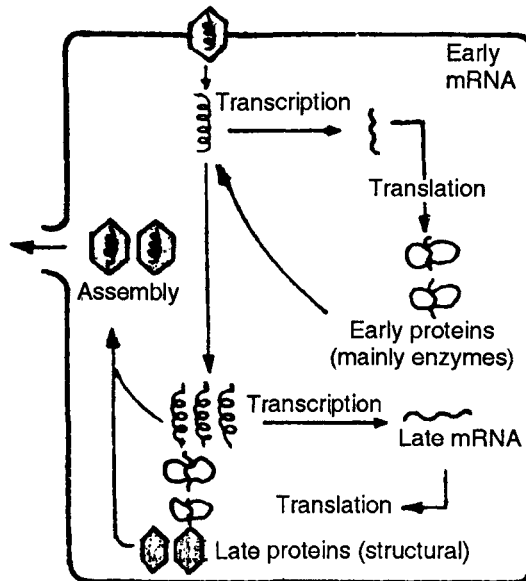

Fig. 4 : Replication of a double-stranded DNA virus

4. (b) Replication of RNA Viruses

A positive strand RNA genome (as in picornaviruses) can be directly translated at the host ribosome. The viral RNA polymerase is expressed first which then synthesizes

the complementary strand of the genome (antigenomic copy) or the negative strand. The antigenomic copy is now used as a template for the replication of the genome. The late viral genes are transcribed from the viral genome, resulting in capsid proteins.

Retroviruses (e.g. HIV) have a positive sense RNA genome but employ a different strategy for genome replication as they first give rise to a complementary DNA molecule by reverse transcription using the enzyme reverse transcriptase. The single stranded DNA copy serves as a template for the synthesis of a double stranded DNA (the provirus), by a cellular DNA polymerase. Provirus is then transcribed by the cellular enzymes to make the viral mRNA and viral genome RNA.

In viruses with negative sense RNA (e.g., Orthomyxoviruses and Paramyxoviruses), the genome is associated with a RNA polymerases which transcribes an antigenomic copy of the genome which is used as the template for virus genome replication.

5. Assembly and Release of Virus Particles

The late expressing genes direct the synthesis of capsid proteins. Once enough protein and DNA are synthesized the two will spontaneously assemble to form virus particles, as in the case plant viruses. In icosahedral virus assembly, it appears that the empty procapsids are first formed and then the nucleic acid is then inserted into the empty capsid in some unknown way. The assembly of enveloped viruses follows the same pattern

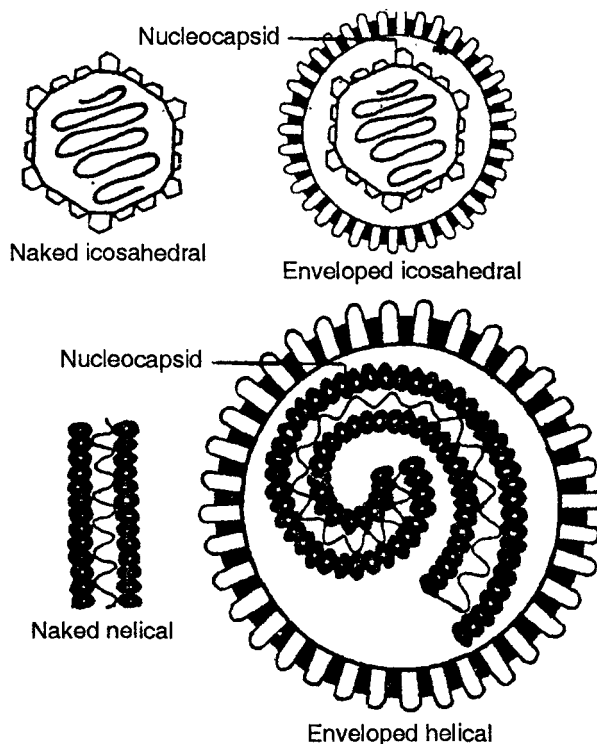

Fig. 5 : Symmetry of viruses: (a) icosahedral; (b) helical

except in the case of pox viruses which follow more complicated pattern and assemble in the cytoplasm rather than the nucleus.

The mechanism of virion release differ between non-enveloped (naked) and enveloped viruses. The virions of naked viruses are released by the lyse of the host cell. In the enveloped viruses, the formation of the envelope and the release of the virus particle is a concurrent process. The viral capsid proteins are first attached to the plasma membrane, and the nucleocapsid is formed on the membrane. The nucleocapsid is released by membrane budding, and the capsids carry the membrane in the process of budding and released. Actin filaments of the host cytoskeleton can aid in virion release.

CLASSIFICATION

The classification of animal viruses is based on the nature of the nucleic acids (DNA or RNA, double stranded or single stranded linear or circular + or -strand), shape of virus particle, presence or absence of envelope and nature of disease caused.

Baltimore (1971) classified animal viruses in the following six groups according to the relationship between virion, nucleic acid and mRNA transcription. The RNA within the virion is known as (+) or sense strand because it acts as mRNA whereas newly synthesized RNA which is complementary in base-sequence to the original infectious strand is called minus (-) or antisense strand. It acts as template to produce additional (+) strand which may acts as mRNA.

Class I dSDNA viruses

The mRNA is synthesized on a dSDNA genome template (\pm dSDNA \rightarrow (+) mRNA) which usually occurs in a cell. Ex- Vaccinia virus, Adenovirus, Herpes simplex virus type I and type II.

Class 2 SSDNA viruses

In such viruses an intermediate DNA is synthesized before the synthesis of mRNA transcript (+ SSDNA \rightarrow + mRNA). The mRNA has same polarity as the DNA. Ex- Parvovirus, Mouse Minute virus.

Class 3 (+) SSRNA virus

The RNA has similar polarity as the mRNA. Viruses of this class are grouped into two classes.

Sub class 3a: Individual mRNA encodes a polyprotein which is broken later on to form viral protein. Ex- Poliovirus

Sub class 3b: From (+) SSRNA two types of mRNA molecules are transcribed one is of same length as virion RNA and the other is a fragment of virion e.g Dengu virus, Yellow fever and St. Louis Encephalites virus.

Class 4 (-) SSRNA

The virion RNA is complementary to mRNA. They are divided into two sub classes.

(a) Sub class 4a: The SSRNA genome encodes a series of monocistronic mRNA. Ex: Mumps virus, Measles virus.

(b) **Sub class 4b:** Each segment molecule of the genome acts as template for the synthesis of mRNA which are monocistronic or encodes polyprotein. Ex- Human influenza virus, Lassa virus.

Class 5 dSRNA viruses

All the viruses of this class have segmented genome. Each chromosome encodes a single polypeptide. The dSRNA acts as template and asymmetrically synthesizes (+) mRNA. Ex- Reovirus of humans

Class 6 RNA-DNA viruses

In these viruses (+) SSRNA directs the synthesis of (-) DNA which in turn acts as template for the transcription of mRNA (RNA → (-) DNA → + RNA), Virion RNA and mRNA are of the same polarity e.g.- Rous Sarcoma virus, Mouse leukemia virus.

Class 7 DNA- RNA virus

This group consists of DNA containing hepatitis B viruses.

TABLE 1
Classification of Human Viruses

Characteristics	Viral family	Viral genus (with representative species) and Un-classified members	Dimensions of virion (Diameter in nm)	Clinical or special features
1	2	3	4	5
Single-stranded DNA, non-enveloped	Parvoviridae	<i>Dependovirus</i>	18-25	Depend on coinfection with adenoviruses; cause fetal death, gastroenteritis
Double-stranded DNA, non-enveloped	Adenoviridae	<i>Mastadenovirus</i> (adenovirus)	70-90	Medium-sized viruses that cause various respiratory infections in humans; some cause tumors in animals.
	Papovaviridae	<i>Papillomavirus</i> (human wart virus) <i>Polyomavirus</i>	40-57	Small viruses that induce tumors; the human wart virus (papilloma) and certain viruses that produce cancer in animals (polyoma and simian) belong to this family.
Double-stranded DNA, enveloped	Poxviridae	<i>Orthopoxvirus</i> (Vaccinia and smallpox viruses) <i>Molluscipoxvirus</i>	200-350	Very large, complex, brick-shaped viruses that cause diseases such as smallpox (variola), molluscum contagiosum (wartlike skin lesion), cowpox, and vaccinia.
	Herpesviridae	<i>Simplexvirus</i> (herpes simplex viruses 1 and 2) <i>Varicellavirus</i> (varicella-zoster virus)	150-200	Medium-sized viruses that cause various human diseases, such as fever blisters, chickenpox, shingles, and infectious mononucleosis; implicated in a type of human

Contd...

...Contd.

1	2	3	4	5
		<i>Cytomegalovirus</i> <i>Lymphocryptovirus</i> (Epstein-Barr virus) Human herpes virus 6		cancer called Burkitt's lymphoma.
	Hepadnaviridae	<i>Hepadnavirus</i> (hepatitis B virus)	42	After protein synthesis, hepatitis B virus uses reverse transcriptase to produce its DNA from mRNA; causes hepatitis B and liver tumors.
Single-stranded RNA, non-enveloped+ strand	Picornaviridae	<i>Enterovirus</i> <i>Rhinovirus</i> (common cold virus) Hepatitis A virus	28-30	At least 70 human enteroviruses are known, including the polio-, coxsackie-, and echoviruses; more than 100 rhinoviruses exist and are the most common cause of colds.
Single-stranded RNA, enveloped+ strand	Togaviridae	<i>Alphavirus</i> <i>Rubivirus</i> (rubella, virus)	60-70	Included are many viruses transmitted by arthropods (<i>Alphavirus</i>); diseases include eastern equine encephalitis (EEE) and western equine encephalitis (WEE). Rubella virus is transmitted by the respiratory route.
	Flaviviridae	<i>Flavivirus</i> <i>Pestivirus</i> Hepatitis C virus	40-50	Can replicate in arthropods that transmit them; diseases include yellow fever, dengue, St. Louis encephalitis, and Japanese encephalitis. The unclassified hepatitis C virus is most likely in this family.
	Coronaviridae	<i>Coronavirus</i>	80-160	Associated with upper respiratory tract infections and the common cold.
-Strand, one strand of RNA	Rhabdoviridae	<i>Vesiculovirus</i> (vesicular stomatitis virus) <i>Lyssavirus</i> (rabies virus)	70-180	Bullet-shaped viruses with a spiked envelope; cause rabies and numerous animal diseases.
	Filoviridae	<i>Filovirus</i>	80-14,000	Enveloped, helical viruses; Ebola and Marburg viruses are filoviruses.
	Paramyxoviridae	<i>Paramyxovirus</i> <i>Morbilivirus</i> (measles virus)	150-300	Paramyxoviruses cause parainfluenza, mumps, and Newcastle disease in chickens.
-Strand, multiple strands or RNA	Orthomyxoviridae	<i>Influenzavirus</i> (influenza viruses A and B) influenza C virus	80-200	Envelope spikes can agglutinate and blood cells.

Contd...

...Contd.

1	2	3	4	5
	Bunyaviridae	<i>Bunyavirus</i> (California encephalitis virus) <i>Hantavirus</i>	90-120	Hantaviruses cause hemorrhagic fevers such as Korean hemorrhagic fever and <i>Hantavirus</i> pulmonary syndrome; associated with rodents.
	Arenaviridae	<i>Arenavirus</i>	50-300	Helical capsids contain RNA-containing granules; cause lymphocytic choriomeningitis and hemorrhagic fevers.
Produce DNA	Retroviridae	Oncoviruses <i>Lentivirus</i> (HIV)	100-120	Includes all RNA tumor viruses and double-stranded RNA viruses. Oncoviruses cause leukemia and tumors in animals; the <i>Lentivirus</i> HIV causes AIDS.
Double-stranded RNA, non-enveloped	Reoviridae	<i>Reovirus</i> Colorado tick fever virus	60-80	Involved in mild respiratory infections and infantile gastroenteritis; an unclassified species causes Colorado tick fever.

TABLE 2
The Animal Viruses

Family	Characteristic	Genome	Genus & common members
1. dSDNA viruses			
(a) Adenoviridae	Icosahedral, 70-90 nm in diameter, naked, linear DNA	35-40	Causes common cold Ex Adenovirus (47 serotype of human adenovirus h- Ad1 to h-Ad 47)
(b) Herpesviridae	Enveloped, icosahedral, linear DNA 100-110 nm in diameter	120-200	Causes herps simplex, Varicella Zoster, human herpes virus 6, Epstein barr virus
(c) Papovaviridae	Icosahedral, 45-55 nm in diameter, circular DNA	5-8	Papilloma virus SV-40, Polyomavirus, Simian Virus - 40
(d) Poxviridae	Brick shaped, complex enveloped 300 x 240 x 100 nm on three sides, double stranded linear DNA	120-300	Variola, Vaccinia, Cow pox, rabbit pox viruses
2. SSDNA viruses			
(a) Parvovirus	Icosaedral, 18-20 nm in diameter, linear DNA, naked	4-5	Parvovirus, Adeno associated virus
3. (+) SSRNA virus			
(a) Coronaviridae	Spherical/helical,	16-21	Human common cold like

Contd...

...Contd.

Family	Characteristic	Genome	Genus & common members
	enveloped 80-130 nm in diameter		diseases, Mouse hepatitis virus
(b) Picornaviridae	Virion icosahedral, naked 25-30 nm in diameter	7	Poliovirus 3, Human echoviruses 32, Rhinoviruses, foot and mouth disease
(c) Togaviridae	Icosahedral enveloped 60-70 nm in diameter	17	Eastern western & venezuelan equine encephalitis viruses, Ross river virus, Rubella virus, Chikungunya virus
(4) (-) ssRNA virus			
(a) Paramyxoviridae	Negative sense, enveloped helical, 150-300 nm in diameter	15	Human Para influenza virus types 1, 2, 3 4 a and 4b, measles virus, Human respiratory syncytial virus, mumps viruses
(b) Rhabdoviridae	Virion bullet shaped, enveloped 180 x 75 nm	12-15	Rabies virus, vesicular stomatitis virus
(c) Orthomyxoviridae	Spherical/helical enveloped 80-120 nm	14	Influenza A,B and C virus
5. dsRNA viruses			
(a) Reoviridae	Icosahedral, naked 60-80 nm	18-30	Reovirus, human and animal diarrhoea virus, Rotavirus
6. RNA-DNA virus			
(a) Retroviridae	Enveloped, icosahedral + ve sense, RNA 80-110 nm	7-10	Human T cell leukemia virus I and II Rous sarcoma, Mammary tumour virus. Human Immunodeficiency virus (HIV I and II)
7. DNA-RNA viruses			
(a) Hepadnaviridae	Enveloped, Icosahedral	13	Hepatitis B virus, Human, Rodents and Birds

PICORNAVIRIDAE

Family Picornaviridae comprises of a large number of very small RNA (pico: small, rna: RNA) viruses with a diameter of 27-30 nm. The capsid is a naked icosahedron made up of 60 protein subunits (protomers). The genome consists of a single linear molecule of single-stranded RNA of positive polarity with 7-8 kilobase pairs. The Picornaviridae is divided into five genera, three of which, *Enterovirus*, *Rhinovirus* and *Hepatovirus* possess human pathogens. Other two genera *Aphthovirus* & *Cardiovirus* cause foot-and-mouth disease and meningoencephalomyelitis in mice respectively. Enterovirus parasitise the enteric tract and rhinoviruses infect the nasal mucosa.

TABLE 3
Human Picornaviruses

Genus	Species	Major disease
Enterovirus conjunctivitis (A24)	Polioviruses 1-3	Paralytic poliomyelitis, aseptic meningitis
	Cosackieviruses A1-24 except 23	Aseptic meningitis, herpangina,
	Coxsackieviruses B1-6	Aseptic meningitis, fatal neonatal disease, pleurodynia, myocarditis or pericarditis.
	Echoviruses 1-34 except 10 and 28	Aseptic meningitis, rashes, febrile illness.
	Enteroviruses 68-71	Conjunctivitis (enterovirus 70), polio-like illness (enterovirus 71), pneumonia & Bronchitis
Rhinovirus	Rhinoviruses 1-100	Common cold
Hepatovirus	Hepatitis A virus	Hepatitis

ENTEROVIRUSES

The poliovirus, coxsackievirus and echoviruses are described as enteroviruses because they are all found in the intestine and are excreted in the faeces. Enteroviruses are among the most stable viruses. They can remain viable for years at -20°C or -70°C and for months at 4°C . In faeces, at room temperature, the virus can remain infective for several weeks. Being non enveloped they are insensitive to ether, chloroform and deoxycholate. The virus is readily killed by moist heat at $50-55^{\circ}\text{C}$, but in food stuffs the virus may survive exposure to 60°C and holder method of pasteurization. Enteroviruses are rapidly inactivated by ultraviolet light, drying, formaldehyde (0.3%), hydrochloric acid (0.1 M) or free residual chlorine (0.3-0.5 ppm). However, higher concentrations of chlorine are necessary to inactivate virus in the presence of organic matter because the latter diminishes the activity of chlorine.

Composition: The RNA genome constitutes about one quarter of the virion. The RNA is single stranded and of positive sense and can be translated directly by host ribosome. The capsid consist of a protein shell arranged in icosahedral symmetry around the RNA molecule. Four major peptides are recognized in the shell VP1, VP2, VP3 and VP4 and are formed from a single precursor protein VP_0 by proteolytic cleavage. Specific neutralizing antibodies are considered to be the major mechanism of protection against infection.

The three groups of viruses those designated as enteroviruses have a number of features in common.

- They attach to cells in the intestinal tract by specific receptor sites and replicate in cells of the intestinal tract.
- They commonly cause asymptomatic immunizing infections, which protect against future infections with the same virus.

- They can give rise to viraemia.
- They occasionally cause infection of CNS and other target organs.
- They are commoner in children than adult.
- In temperate climate they cause infections usually in the summer and autumn.

POLIOVIRUSES

On the basis of neutralization tests, polioviruses can be divided into three serotypes. Type 1 is the common epidemic type, type 2 is usually associated with endemic infections and type 3 occasionally causes epidemics. The size chemical properties and physical properties and resistance of the three types are all identical and so their antigenic properties provide one of the main method to differentiation. These viruses have affinity for nervous tissue and narrow host range. Only man and some primates like cynomologous and rhesus monkeys are susceptible. These monkeys can be infected by the oral route and develop paralysis.

Considerable interest was generated in poliomyelitis after 1916 when more than 27,000 persons were paralysed and 6,000 died in a major epidemic in the USA which had mainly hit the adult population.

Natural infection occurs only in man. The virus is spread from man to man by faecal-oral route and because early multiplication occurs in both the oropharynx and the intestinal mucosa, therefore, the virus is also spread by pharyngeal secretions (droplet infection) during first week of illness. No intermediate host is known.

On entering the body of a new host the virus multiplies in the tonsils and Peyer's patches of the ileum. Spread to regional lymph nodes (cervical and mesenteric) leads to a viraemia, enabling the virus to become disseminated throughout the body including cord and brain.

Pathogenesis

1. Neural spread may occur in children with inapparent infection at the time of tonsillectomy. Poliovirus present in the oropharynx may enter nerve fibres exposed during surgery and spread to brain resulting in bulbar paralysis.
2. A similar mechanism of viral spread via neural pathways may be responsible for paralysis of a limb recently injected with inflammatory injections such as diphtheria-pertussis-tetanus (DPT) vaccine. This is probably associated with the irritant properties of the adjuvant.
3. Pregnancy increases the incidence of paralysis.
4. Muscular activity during the paralytic phase of the illness may lead to paralysis of the limbs used.

Clinical Features

There are three types of poliovirus infection:

- (1) Asymptomatic or mild infection, transient 'influenza like' illness. The virus is

excreted in the faeces for a limited time and an immunological response develops which protect against re-infection with the same strain.

- (2) Infection with same symptom and involvement of CNS with headache, neck stiffness and back pain (meningitis). Rapid and complete necessary is less than 10 days is usual.
- (3) Paralytic poliomyelitis in which patient develops paralysis. This is very uncommon, occurring in one in 1000 of polio virus infection in children. The paralysis is flaccid due to destruction of lower motor neurons, although invasion of the brain stem cells by virus can lead to inco-ordination of muscle groups and painful spasms. Paralysis occur early in the illness but the extent is invariable. Damage to the nerve cells in the brain stem can lead to the inability to swallow and breathe.

In the CNS the virus multiplies selectively in the neurons and destroy them.

Prophylaxis

The WHO had set a target date of the year 2000 as the global eradication of poliomyelitis. Although overall the number of cases has fallen more than 95%. 30 countries of South Asia and West and Central Africa has recent reports of the cases. A new dead line has set to be 2005. The eradication has been attempted with annual national immunization days to ensure each child receives an adequate number of doses of oral poliovaccine.

Two effective vaccines are available:

- Inactivated polio vaccine (Salk), and
- Live attenuated oral polio vaccine (Sabin)

Inactivated Polio Vaccine (IPV)

IPV (Salk) for parental injection was developed by Jonas Salk in 1956. The vaccine contains formalin inactivated strains of the three serotypes of virus grown in monkey kidney cell culture. The vaccine is given by deep subcutaneous or intra-muscular injection. Three injection are given with intervals of 6-8 weeks between the first and second doses and 4-6 months between the second and third doses. IPV produces long-lasting immunity to all three poliovirus types. It is not associated with local or general reactions. The injection of this vaccine stimulates the production of IgG antibodies in the serum. It does not induce detectable levels of secretory IgA in the gut and therefore would not be expected to prevent alimentary tract infections. Following infection, a virulent virus is neutralized as it enters the blood stream, thus preventing involvement of the central nervous system. The absence of live virus makes it safe to administer to immunocompromised individuals.

Live Attenuated Oral Polio Vaccine (OPV)

OPV (Sabin) was developed by Albert Sabin in 1962. It contains live attenuated stains of the three serotypes of poliovirus grown either in cultures of monkey kidney cells

or human diploid cells. The virus comprising the vaccine is unable to multiply in the cells of the central nervous system and therefore lacks neurovirulence. The vaccine is administered orally and parallels natural infection. It stimulates both local secretory IgA antibodies in the pharynx and alimentary tract and humoral IgG antibodies. Virus is excreted in the faeces for several weeks, during which time the vaccine may spread to close contacts, inducing or boosting immunity in them.

At the age of one and a half months first dose of OPV is given along with DPT. Second, third and fourth doses of these vaccines are given at the ages of 2¹/₂, 3¹/₂ and 16-24 months, respectively. With multiple rounds of replication in the vaccine and after transmission to the contact, there is a theoretical possibility that the vaccine virus may revert to neurovirulence. The risk of vaccine-associated poliomyelitis has been estimated at between 0.5 and 3.4 cases per million. OPV used in India is stated to contain Type 1 virus 10 lakh, Type 2 virus 2 lakh and type 3 virus 3 lakh, TCTD 50 per dose (0.5 ml). The shelf life of vaccine at 4-8°C is 4 months and at -20°C is 2 years.

COXSACKIEVIRUSES

These viruses were named so because the first isolation was made from Coxsackie village in New York by Dalldrof and Sickles (1948). Based on the pathological changes produced in suckling mice, coxsackieviruses are classified into two groups, A and B.

TABLE 4

Coxsackieviruses

	Group A	Group B
Pathological changes induced by inoculation of suckling mice	Generalized myositis Flaccid paralysis Death within a week	Patchy focal myositis Spastic paralysis Localized lesions in the liver, pancreas, myocardium brain and brown fat pads.
Number of types by neutralization test	23 (1-24 except 23)	6(1-6)

Like other enteroviruses, coxsackieviruses inhabit the alimentary canal primarily and are spread by faecal-oral route. They may cause following lesions:

Group A Viruses

Coxsackie A virus: Group A virus of which there are 24 serotype cause widespread sever myosites of skeletal muscles and in life the mice appears to have a flaccid paralysis. The sign of infection appears 4 or 5 days after inoculation and progress until the animal dies 4 or 5 days later.

Coxsackie B Virus: Group B virus of which there are six, cause widespread lesions in many organs. The myositis produced is characterized by focal lesions and spastic

paralysis. The virus cause areas of necrosis in the brown fat lobules, meningo-encephalitis and pancreatitis. The incubation period of B virus in mice is prolonged.

These viruses give rise to:

1. **Aseptic meningitis:** It is caused by types 2, 4, 7 and 9.
2. **Herpangina (vesicular pharyngitis):** It is caused by types 2, 4, 5, 6, 8, and 10. It is usually seen in young children. Outbreaks may be seen in nurseries and schools. There is an abrupt onset of fever and sore throat. The illness is self-limited.
3. **Hand-foot and - mouth disease:** It is usually caused by types 5 and 16 and is predominantly a childhood illness. The disease presents as a painful stomatitis with a vesicular rash on the hands and feet.

Group B viruses

1. **Epidemic myalgia (Bornholm disease):** It is so called because it was first described on the Danish island of Bornholm. It is a febrile disease with stitch-like pains in the muscles of the chest (intercostals), epigastrium or hypochondrium. Involvement of diaphragm leads to abdominal pain.

2. **Myocarditis and pericarditis:** Group B viruses may lead to severe and often fatal myocarditis in newborn infants. Myocarditis and pericarditis may also occur in children and adults.

3. **Aseptic meningitis:** Group B viruses may cause aseptic meningitis sometimes with paralysis.

Echoviruses

These viruses were originally isolated from the faeces of persons who had no clinical illness and caused a cytopathic effect in cell culture. Therefore, these viruses were given the name of enteric cytopathogenic human orphan viruses (echoviruses). On the basis of the presence of a type-specific neutralizing antigen in their capsid, echoviruses have been sub-divided into 34 (1-34 except 10 and 28) types. All echoviruses grow well in human and simian kidney cultures. They infected only human beings naturally.

Most of the echoviruses produce asymptomatic infections but some have been associated with clinical syndromes such as aseptic meningitis, paralysis, fever with rash, respiratory disease (pneumonia, bronchiolitis and upper respiratory tract illness), infantile diarrhoea, pericarditis and myocarditis.

Echoviruses can be readily isolated from nose and throat swabs, stools or CSF on human diploid embryonic lung fibroblast and human rhabdomyosarcoma cell line. The cytopathic effect and the identification of the virus type is similar to that of coxsackieviruses. Vaccination has not been attempted.

Enteroviruses 68-71

Of the four enteroviruses 68-71, three are associated with disease in human beings.

TABLE 5
Diseases Produced by Enteroviruses 68-71

Enterovirus type	Disease
68	Pneumonia and bronchitis
69	-
70	Acute haemorrhagic conjunctivitis, meningoencephalitis and paralysis
71	Meningoencephalitis and paralysis

Enterovirus 70: In 1969, a pandemic of acute haemorrhagic conjunctivitis (AHC) spread throughout Africa and Asia. Recently, the disease occurred in Mexico. AHC is highly infectious, has an incubation period of about 24 hours and the symptoms are sudden swelling, congestion, watering and pain in the eyes. Although sub conjunctival haemorrhage is a characteristic feature, most cases recover in 3-7 days. Sometimes enterovirus 70 may cause meningoencephalitis and paralysis. It can be isolated on human embryonic kidney and HeLa cells.

Rhinoviruses

The common cold is probably the most common infectious disease of human. Rhinovirus term was applied to this group (rhino referring to 'nose' the organ primarily affected).

They differ from enterovirus is being more acid labile, but more heat stable. They are inactivated below pH 6. They are relatively stable at 20-37°C and may remain viable for days. Over 100 serotypes has been classified on the basis of their type specific antigen.

The virus attaches to receptors on nasal ciliated epithelial cells, enters and replicates within them spreading to other cells.

Rhinoviruses are small RNA viruses, morphologically and biochemically similar to other members of the family picornaviridae. They can be differentiated from the enteroviruses on the basis of their acid lability (thus their inability to infect the intestinal tract) and their optimal temperature for replication (33°C). They are inactivated below pH 5. They are relatively stable in temperature, range of 20-37°C and can survive on environmental surfaces such as door knobs for several days. Some rhinoviruses may survive heating at 50°C for 1 hour. They are resistant to 20% ether and 5% chloroform but are sensitive to aldehydes and hypochlorites. They can be preserved at -70°C.

Some strains grow in both monkey & human cell lines, these are designated as M strains and those which grow only in human cells are known as H strains.

Pathogenesis

Rhinoviruses are the major cause of common cold accounting for about half of all colds. Other viruses which may also cause common cold include coronaviruses, some enteroviruses particularly coxsackieviruses A21 and A24 and echoviruses 11 & 20,

respiratory syncytial virus, para influenza viruses and the low numbered adenoviruses. Rhinoviruses are transmitted by inhalation of droplets expelled from the nose of a patient during sneezing and coughing. During the acute phase of the illness high concentrations of virus are present in nasal secretions which may contaminate hands, fingers, handkerchiefs or paper tissues, door knobs, etc and the normal individuals who touch these, contaminate their fingers which may touch the eye or nasal mucosa leading to cold. For rhinoviruses, hand contact seems to be the prime mode of transmission. Rhinovirus infections are observed throughout the year, but the incidence of cold in temperate climates increases in the autumn and spring and in the tropics the peak incidence occurs in the rainy season.

After an incubation period of 2-4 days, patient develops profuse watery discharge (rhinorrhoea) with nasal obstruction, sneezing, sore throat, cough, headache, malaise and little or no fever. On an average, symptoms subside in about a week but in a proportion of the cases the symptoms may be prolonged for 2 weeks or longer. Sinusitis or otitis media may supervene, particularly if secondary bacterial infection occurs. The illness is generally worse in smokers. Recovery is mediated by endogenous interferons, locally synthesized IgA antibodies and serum IgG antibodies. The multiplicity of serotype makes vaccination impossible. Interferon is usually detectable shortly after the peak of virus shedding and probably play a part in recovery. Pleconaril is one such drug showing activity against rhinovirus and enterovirus. Good infection control practices including hand washing will reduce spread of infection in the hospital setting.

RHABDOVIRUS

The family Rhabdoviridae consist of more than 200 viruses of vertebrate, invertebrate and plants. It has two genera. Vesiculovirus and Lyssavirus. The member of genus vesiculovirus causes vesicular stomatitis in horses, cattle, and pigs and only one of the 35 serologically distinct viruses of this genus causes human infection. The genus lyssa virus contain rabies virus and five rabies like viruses: Mokola, Lagosbat, Kotonkan, Obodhiang and Duvenhage viruses. Each of these viruses are capable of causing rabies like disease in domestic animals and humans.

The bite of an infected animal like dog, cat, bat or skunk can transmit the disease to man.

Morphology

(Rabies name come from the latin word rabidus = mad)

Rabies virus is bullet shaped 180 x 75 nm with one end rounded conical and the other plane or concave. The core of the virion consists of a minus sense 11-12 Kb. Single stranded (-) RNA enclosed in helically wound nucleocapsid. RNA dependent RNA polymerase enzyme (required for initiation of replication of virus) is enclosed within the virion in association with the ribonucleoprotein core. This ribonucleoprotein core is surrounded by viral membrane or matrix protein which may be invaginated at the plane end. The matrix protein is again surrounded by a lipoprotein envelope which carries glycoprotein peplomers (spikes). The spikes do not cover the plane end of the virion.

Symptoms

The symptom in human include severe headache and high fever with alternating stages of excitement and depression. Patients have difficulty in swallowing and slight stimuli incite muscular spasms in the throat and chest. Death may occur due to convulsive seizures. The mortality rate in untreated patients is nearly 100%. The course of disease in humans can be classified into four stages- prodrome, acute encephalitic phase, coma and death. The onset is marked by prodromal symptoms like fever, headache, malaise, fatigue, and anorexia. An early symptom is often a neuritic type of pain or Paresthesia and fasciculation at the site of virus entry. Apprehension anxiety, agitation, irritability, nervousness, insomnia or depression characterise the prodromal phase, last for 2-4 days. Excessive libido, priapism, and spontaneous ejaculation may occur rarely.

The acute neurological phase usually begins with hyperactivity with bouts of bizarre behaviour, agitation or seizures appearing between apparently normal periods.

Some patients progress to paralysis. Death is due to respiratory arrest or other complications.

After the bite of a rabid animal the incubation period is usually between 1-2 months. However it may be as short as 9 days and rarely as long as a year or more. It is shorter in children than in adults and also in person bitten on face or head than bitten on the legs. This is related to the distance the virus has to travel to reach the brain. Patients develops difficulty in drinking, together with intense thirst. Attempts to drink bring on painful spasm of pharynx and larynx producing choking and gagging. Therefore mere sight or sound of water precipitates distressing muscular spasm leading to hydrophobia (fear of water).

The furious form of rabies, gradually subsides into delirium, convulsions coma and death. Sometimes only the dumb form is seen, with symmetrical ascending paralysis followed by coma and death. The disease, once developed is almost always fatal in 4-14 days. Rabies virus may be secreted in the saliva, urine and other secretions of human rabies victims as in that of animals.

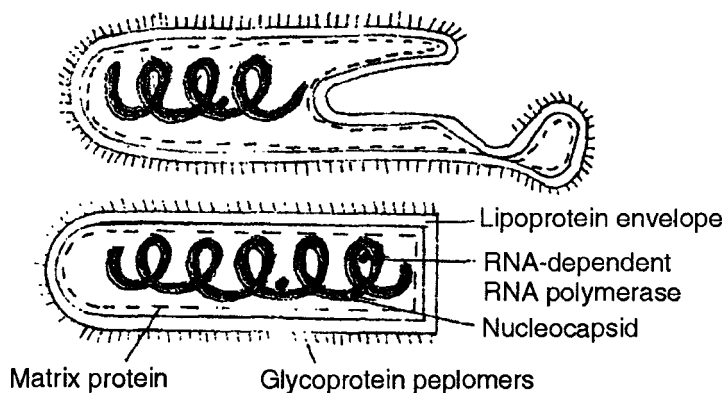

Fig. 6 : Rabies virus

Pathogenesis

Rabies is a natural infection of dogs, foxes, wolves, skunks, cats and bats. Rabies virus is excreted in the saliva of affected animals. Man acquires infection by the bite of rabid dog or other animals. Rarely infection can occur following licks on abraded skin and intact mucosa. Infection has occurred through the inhalation of massive virus aerosols generated in bat caves and in laboratory accidents.

Infection by bite of rabid animal results in deposition of rabies infected saliva deep in the striated muscles. The virus replicates in the muscle cell or cells of epithelial tissues. After reaching a sufficient concentration it infects peripheral nerves in the muscle or skin. Once within the nerve fibres it is out of reach of any circulating antibody and travels along the axon towards the central nervous system at a speed of 3 mm per hour. In the central nervous system it multiplies and produces encephalitis. The virus then spreads outwards along the nerve trunks to various parts of the body including the salivary glands. It multiplies in the salivary glands and is shed in the saliva. There is little evidence that haematogenous or other modes of spread are involved.

The presence of virus in the saliva and the irritability and aggression brought on by the encephalitis ensure the transmission and survival of the virus in nature. The virus ultimately reaches virtually every tissue in the body and is almost invariably present in the cornea and the skin of face and nape of the neck of the patient because of their proximity to the brain. This provides a method for the antemortem diagnosis of rabies. The virus may also be shed in the milk and urine. In humans the incubation period is 1-3 months or may be as short as 7 days or as long as three years.

Exposure of humans to rabies virus does not necessarily result in infection. Contrary to popular belief, man is not highly susceptible to the virus. The incidence of human rabies after bites by known rabid dogs is about 15%. However, the incidence ranges from 1% after contamination of minor wounds to more than 60% after severe bites on the face.

In dogs the incubation period is usually 3-6 weeks but it may range from 10 days to a year. The initial signs are an alert, troubled air and a change in disposition with restlessness. Snapping at imaginary objects, licking or gnawing at the site of the bite. After 2-3 days of this prodromal stage the disease develops into either the furious or dumb type of rabies. In furious rabies (more common) the dog runs amok, biting without provocation & indiscriminately. The lower jaw droops and saliva drools from the mouth. Paralysis, convulsions and death follow. In dumb rabies the animal lies huddled, unable to feed. The dog may not bite but attempts to feed it are dangerous. About 60% of rabid dogs shed the virus in saliva. Rabid dogs usually die in 3-5 days.

The characteristic histopathological feature in rabies is the intracytoplasmic inclusion body (Negri body) in the neurons, most abundant in cerebellum and hippocampus. Negri bodies are composed of a finely fibrillar matrix and rabies virus particles.

Physical and chemical properties: The virus is sensitive to ethanol, iodine preparations, quaternary ammonium compounds, soap, detergents and lipid solvents like ether, chloroform and acetone. It is inactivated by phenol, formalin, UV radiation and

sunlight. It dies at room temperature but can survive for weeks when stabilized by 50% glycerol. It can be preserved at -70°C by lyophilisation.

Transmission: The portal of entry from the infected saliva of a rabid animals are:

- abrasions or scratches on the skin.
- mucous membrane exposed to saliva from licks.
- most frequently via deep penetrating bite wounds uncommon routes include:
- inhalation while in bat infested areas/caves
- aerosols released during centrifugation of infected material in the laboratory.
- ingestion of flesh of rapid animals.
- corneal transplants.
- Humans do not figure as spreaders of rabies.

Epidemiology

Rabies virus is present in animals in all parts of the world except Australia and Antarctica, and some islands like Britain. Two epidemiological types of rabies exist-urban, transmitted by domestic animals like dogs and cats, and sylvatic, involving animals in the wild, such as jackals, wolves, foxes, mongooses, skunks and bats. Most cases of human rabies follow dog bites but in endemic areas almost any animal can transmit rabies. In India, antirabic treatment is to be considered following the bite of any animal except rats. Where urban or domestic rabies has been controlled, as in the USA, the majority of infections are due to bites by wild animals.

The primary source of the rabies virus in nature seems to be in the mustelids and viverrids, the ermine in the northern coniferous forests, the skunk, mink and weasel in North America, the mottled pole cat in the USSR, the civet and pole cat in Africa and the mongoose in Asia. Rabies virus has been isolated repeatedly from the brain and salivary glands of apparently healthy wild rodents. The virus survives in this reservoir population by achieving a state of latency with occasional activation such that only a small proportion of them will be shedding the virus at any one time. From the reservoir species, wild vectors such as foxes, wolves and jackals acquire the infection and occasionally epizootics occur in these species. Carnivorous animals may acquire the infection by eating carcasses containing the virus. From these species the disease spreads to dogs and other domestic animals.

Another natural cycle of rabies concerns bats. A fatal paralytic disease of cattle & humans was noticed in Central and South America and the west Indies early in the twentieth century. This was identified as rabies only years later. The disease was shown to be transmitted by vampire bats that sweep down on their prey at night. Vampire bat rabies had taken a heavy toll of cattle. Vampire bats may shed the rabies virus as symptomless carries over a period of several months.

Rabies is endemic in India. It has been estimated that more than 30,000 people die of rabies in India every year and more than 700,000 receive antirabies vaccine. Human rabies can be checked by control of rabies in domestic animals, by registration, licensing

and vaccination of pets and destruction of stray animals. With the dog population in India estimated as over 16 million, the problem is immense. However, rabies can be eliminated only if the wild vectors such as jackals and foxes, and the reservoir mustelids and viverrids are controlled. Rabies has been eliminated from islands like Britain and Japan by rigid quarantine. Australia which has no native mustelid or viverrid population has no rabies. Eradication of rabies from countries like India with abundant wildlife may not be practicable.

Vaccination

Pasteur introduced vaccination after exposure to rabies in 1885 on the basis that a long incubation period should allow time for immunity to develop before the onset of symptoms. His vaccine was a crude extract of rabbit spinal cord containing virus "fixed" as a result of serial passage. A well publicized early success established the procedure, still in use despite various vicissitudes. A phenolized brain suspension formed the basis of the sample vaccine, used in the UK from 1919 until 1966. Its drawbacks included a variable but generally low potency, which necessitated a considerable number of daily, often painful, injections, with an antibody response mainly of the IgM class. There was also the disadvantage that the amount of myelin in its nervous tissue content sensitized a proportion of those being immunized, estimated to range from 1 in 500 upwards so that many went on to develop an allergic type of encephalomyelitis. When the risk of a possible exposure to a rabid animal was assessed as only marginal, it was matter of debate whether the risk of rabies was greatest than the risk of allergic encephalomyelitis.

A suckling mouse brain vaccine was developed and contains much less myelin. It is claimed to have a five fold reduction or more in the incidence of allergic encephalomyelitis, and is widely used in Latin American countries. A non-neurogenic duck embryo vaccine was used in the UK from 1966 to 1976. A purified version has shown increased potency, but this vaccine has been superseded by cell culture vaccines, of which there are several types. Those available worldwide, though not necessarily used because of their high cost, include:

- diploid cell vaccine
- rabies vaccine adsorbed
- purified chick embryo cell vaccine
- vero cell vaccine

These all have good immunogenicity and safety.

The diploid cell vaccine is the only one licensed in the UK for both pre and post-exposure prophylaxis and is the only vaccine recommended for intradermal administration. Severe reactions are rare after use, though up to 20% may report minor local effects, and a smaller proportion report systematic, influenza-like or sensitization effects. Intradermal vaccine is not recommended while antimalarials are in use because these may interfere with the immune response. Immuno-suppressed persons may show a poor response and should have antibody levels checked.

Several vaccine types and modes of delivery have been used in animals. Those used

in dogs and cats are given intramuscularly, and require boosting every 1-3 years depending on the vaccine type. Attempts have been made to control the infection in wild animals by the use of live-attenuated vaccines delivered orally. By carefully selecting desirable baits, such as chicken heads for foxes, successful vaccination programmes have been carried out in several European countries.

Work continues on a number of recombinant and subunit vaccines, and an alternative antibody preparations to use in humans.

Control

Because rabies has a world wide distribution its complete elimination would need the eradication of infection from all susceptible animal species. First steps in this direction have been the use of vaccine-impregnated baits to reduce rabies in foxes in Europe and Canada and Raccoons in the USA. Since most human exposure has resulted from contact with infected dogs and cats, vaccination of domestic dogs and cats combined with post-exposure prophylaxis for those exposed in specific incidents to suspect rabid animals and pre-exposure for those who may come in contact with such animals in the course of their work has reduced the number of human cases in many countries. Pre-exposure vaccination is recommended for the following groups:

- Laboratory workers handling the virus
- Those handling imported animals at animal quarantine centres, zoos, research centres and ports.
- Veterinarians and their technical staff
- Animal health inspectors
- Licensed bat handlers
- Travelers to enzootic areas if work involves handling animals or patients with rabies.
- Those traveling more than a day's journey from modern medical treatment.

Pre-exposure immunization requires two injections of 1 ml of vaccine, given into the deltoid muscle 4 weeks apart. A test for neutralizing antibody is advised 4 weeks later. A re-inforcing dose is given at 12 months. A booster should be given after any potential exposure. Those at high risk of exposure should have periodic antibody testing and boosting as required every 6 months to 2 years.

Clear signs of case reduction have come from the developed countries that have applied this scheme, and now the need is to extend the procedure to other, particularly enzootic, regions where dogs are the major reservoir of the virus. Past attempts to control wild life rabies by such draconian measures as shooting and gassing have had short-lived effects. Species vary in their susceptibility to rabies and live vaccine strains that may be used for one species may be unsuitable for another. Extension to canine and other species may become feasible when suitable oral vaccine strains are identified. A number of vectors, such as vaccinia, raccoon pox virions, fowl pox, canary pox and adenovirus, have been used to express a recombinant rabies glycoprotein gene with successful induction of neutralizing antibody in a variety of animal species.

ROTAVIRUSES

Rotavirus infections are usually mild to moderately severe in developed countries but can become very severe and cause high mortality in developing countries. Rotaviruses also cause diarrhoea in the young of a wide variety of mammals and birds. In the early 1980s, a rotavirus (adult diarrhoea rotavirus, ADRV) was identified as the cause of outbreaks of diarrhoea in children and adults in different parts of China.

Morphologically, rotaviruses are polyhedrons of 75 nm diameter displaying characteristic sharp-edged double-shelled capsids, which in electron micrographs look like spokes grouped around the hub of a wheel. The name 'rotavirus' was derived from this appearance which is pathogenomic. More detailed structural studies have shown that the double-shelled capsid is penetrated by a large number of channels and that it carries on the surface of 60 protrusions that consist of dimers of VP4 (viral protein 4) molecules.

The genome of rotaviruses is located inside the inner core and consists of 11 segments of double-stranded RNA that can be easily extracted from viruses and separated by polyacrylamide gel electrophoresis. All segments, except one, code for only one virus-specific protein (VP), and gene-protein assignments have been completed for several rotavirus strains.

RNA segments 1, 2 and 3 code for the inner core proteins, VP1, VP2 and VP3, respectively: VP2 is the main scaffolding protein (core layer). RNA segment 6 codes for the inner capsid protein, VP6 which forms a middle layer interacting with the core protein VP2 and the outer capsid proteins. VP6 carries epitopes specifying groups & sub groups. So far, seven different groups (A-G) have been identified. For groups A-E complex lack of serological cross-reactivity has been proven. Within a group, all viruses share common VP6 antigens but may be further differentiated into sub groups. Thus, within group A there are at least four subgroups (I, II, I + II, non - I, non - II), which are identified by specific antisera and monoclonal antibodies. Most of the human rotaviruses are of group A; the Chinese ADRV is a group B; group C rotaviruses cause occasional outbreaks in humans. The outer capsid (third layer) is formed by two proteins, VP7 a glycoprotein (encoded by RNA, 7, 8 or 9 depending on strain), and VP4 (encoded by RNA 4). Both surface proteins carry neutralization -specific epitopes that define serotypes. VP4 is post-translationally cleaved into the VP5 and VP8 subunits; proteolytic cleavage is essential for infectivity. Six non-structural proteins (NSP1-NSP6) are coded for by RNAs 5, 7, 8 or 9 (depending on strain), 10 and 11 (encoding NSP5 + NSP6), and have various functions during replication, mainly in morphogenesis.

So far, 14 different VP7-specific serotypes (G types, derived from glycoprotein) and over 20 different VP4- specific types (P types, derived from protease-sensitive protein) have been distinguished. Whilst the correlation between G serotypes and genotypes is complete, not all P types have been confirmed as serotypes yet, and therefore the P serotype designation differs from the P genotype designation, e.g., strain Wa being designated as A/human/Wa(GIP1A[8]) etc. As VP7 and VP4 are coded for by different RNA segments, they can segregate independently, and a large variety of different G-P-type combinations of rotaviruses have been observed after reassortment *in vitro* and *in nature in vivo*. Animals

from which rotavirus can be readily isolated are cattle, sheep, horses, pigs, dogs, cats and mice, but also elks, rabbits, monkeys and many others.

Electrophoresis of genomic RNA segments (PAGE) has been used to establish so-called 'electropherotypes' of rotavirus isolates. Besides 'long' and 'short' electropherotypes (differing in the rates of relative migration of RNA segments 10 & 11). Various minor differences in the migration of corresponding segments have been recognized. These differences have been utilized extensively in epidemiological studies, but for many surveillance purposes and for vaccine development serological classification remains essential.

Pathogenesis and Immunity

Rotaviruses replicate exclusively in the differentiated epithelial cells at the tips of the villi of the small intestine. New virus is produced after 10-12 h. Progeny virus is released in large numbers into the intestinal lumen ready to infect other cells. Biopsies show atrophy of the villi with reactive crypt hyperplasia and lymphocytic infiltrates in the lamina propria. The cellular damage leads to malabsorption of nutrients, electrolytes and water and the crypt hyperplasia to hypersecretion. An osmotic and secretory diarrhoea with vomiting and dehydration results. It has been established that the product of RNA 4, VP 4, holds a central position for replication, spread and pathogenicity of rotaviruses, but that products of other RNA segments also contribute to the development of disease. In particular NSP4 (encoded by RNA segment 10) has been recognized as a viral enterotoxin.

The infection is followed by a local, humoral and cell-mediated immune response and is normally overcome within a week. Rotavirus-specific IgA enteric antibodies, which are secreted into the gut, are the best known correlate of protection. Infection with one serotype provides homotypic, and re-infection leads to partial heterotypic, protection. In the immunodeficient host, however, a persistent infection can occur with severe chronic diarrhoea.

Clinical Symptoms

The onset of symptoms is abrupt after a short incubation period of 1-2 days. Diarrhoea and vomiting are seen in the majority of infected children and last for 2-6 days. Although symptoms of respiratory tract infection are frequently observed at the time of rotavirus infections, there is no evidence that rotaviruses replicate in the respiratory tract. Clinical symptoms can range from mild to very severe, in part depending on the rotavirus strain. Asymptomatic infections of neonates with 'nursery strains' are not uncommon. It has been estimated that about half of all gastro-enteritis cases in children requiring admission to hospital are caused by rotaviruses. Infection has been detected in older children and adults, but is usually asymptomatic. Only in the elderly have outbreaks of diarrhoea due to rotavirus infection been observed. Rotavirus infections can be life-threatening if children are already malnourished. Five million children under the age of 2 years die from diarrhoeal disease in developing countries each year, rotavirus infections account for about 20% of these deaths.

Epidemiology

Rotavirus infections occurs world wide. Most symptomatic infections are seen in children under 2 years of age; by the age of 3 years, more than 90% of children have been infected by most of the major serotypes. In family outbreaks there may be evidence of sub clinical infection in older children and adults who may be the source of infection for young children in family or nursery outbreaks. The release of enormous numbers of virions during the acute stage contributes to the easy transmission of the virus. Only a few virus particles are sufficient to cause disease in the susceptible host. Longer-lasting outbreaks may be maintained by the ability of the virus to survive outside the body for some time. In temperate climates there is a pronounced seasonal incidence, with peaks in the winter months occurring with 'clock wise precision'. In tropical areas infections occur evenly throughout the year.

Various surveys in different parts of the world have shown that at any time there is co-circulation of genomically and serologically different rotaviruses. In tropical and subtropical regions, high prevalence of G/P constellations are seen which are rare in temperate climates (e.g., G8P[6], G9P[11], G9P[6] viruses have recently emerged in a number of countries of several continents).

At the molecular level, several factors have been identified that can explain the genomic and antigenic variability of co-circulating rotavirus strains:

- Like the genomes of other viruses that depend on virion-associated, RNA-dependent RNA polymerases for their replication, rotavirus genomes undergo frequent point mutations that accumulate in time and give rise to lineages and sub lineages.
- Rotaviruses, like other segmented RNA viruses, undergo extensive reassortment in doubly infected cells. This has been shown to occur both *in vitro* and *in vivo*. If RNA segments coding for sub groups and serotype-specific proteins are involved, antigenic shift can occur in reassortants.
- Rotaviruses may be transferred into humans from animal species, and this may contribute to the genomic variability. Human group A rotavirus isolates have been described, the genome of which is very closely related to that of cat and cattle rotaviruses. ADRVs of group B may have been derived recently from animals, perhaps rats. On the other hand, human group C rotaviruses are significantly different from animal group C rotaviruses.
- Rotaviruses establishing chronic infections in immunodeficient hosts undergo various forms of genome rearrangements, resulting in highly atypical RNA profiles. Evidence is now emerging that such rearrangements may occur more frequently than originally thought.
- Various combinations of these factors may occur e.g. reassortment of viruses with rearranged genomes, or point mutations combined with reassortment.

Treatment and Control

Therapy consists mainly of oral, sometimes intravenous, rehydration with fluids of

specified electrolyte and glucose composition. Antimotility drugs (codein phosphate, loperamide) are generally not advised for use in children, but recently developed enkephalinase inhibitors (e.g. racecadotril) which decrease gut secretion but not motility have been given successfully to children.

As with any infectious agent transmitted by the faecal-oral route, attention to hygienic measures such as hand washing and disinfection of contaminated surfaces and safe disposal of faeces are very important.

For a variety of reasons, rotavirus infections have so far resisted prevention by widespread vaccination. Co-circulation of several serotypes at a time occurs in populations at risk, which is also reflected in polytypic serum antibody responses. Furthermore, it is not fully clear to what extent vaccination with one rotavirus serotype cross-protects against other serotypes. However, polyvalent 'cocktail' vaccines containing two or more different serotypes have been shown to have a significant effect on prevention severe disease. One of them, a rhesus rotavirus-based tetravalent human reassortant vaccine (RRV-TV, RotashieldTM), had been licensed in the USA in 1998 for universal use, and over 1.5 million doses (three doses per child at the ages of 2, 4 and 6 months) were administered over the following year. However, the vaccine had to be revoked and taken off the market when a strong epidemiological link between application of the first (and second) dose of the vaccine and the development of gut intussusception became apparent.

A number of different candidate vaccines of live-attenuated rotavirus of bovine or human origin, including bovine rotavirus monreassortants carrying human VP7 genes of different serotypes, are currently being evaluated. Baculovirus-expressed virus-like particles, DNA-based vaccines and micro-encapsidated viral proteins or cDNAs are also being explored. It is hoped that (an) efficient rotavirus vaccine(s) will become available in the not too distant future.

ACQUIRED IMMUNE DEFICIENCY SYNDROME; LYMPHOMA HIV VIRUS

Virions of the family Retroviridae possess reverse transcriptase enzyme hence the name (Re: reverse, tr: transcriptase) The family retroviridae has been divided into 3 sub families of the seven genera included in this family three contain human retroviruses. Human T cell lymphotropic virus Type 1 (HTLV-1) is an oncogenic virus. It causes adults T cell leukaemia/lymphoma. HTLV-2 is prevalent in intravenous drug users, but has not been associated with disease. They have been studied in the laboratory for many years, initially because some are associated with tumour production in their natural hosts. Indeed, a wide variety of tumours are caused by the oncovirus genus, including leukaemias and lymphomas, sarcomas, breast and brain tumours, auto-immune disease and blood disorders. The host species include birds, mice, cattle, pigs and several primates. Despite intense effort, it was not until 1980 that the first human retrovirus was isolated from the T cells of patients with T cell leukaemia-the human T lymphotropic virus type-1 or HTLV-1. Since then, the cause of the acquired immune deficiency syndrome (AIDS) has been shown to be a retrovirus, also with a predilection for T cells but differing significantly from HTLV-1. It is known as the human immuno deficiency virus type 1 or HIV-1. Infection with this virus has become pandemic and is a major cause of mortality in sub-saharan

Africa and other developing countries. Infection with the related HIV-2 is restricted largely to west Africa and shows a lesser pathogenicity. Viruses that produce tumours in their natural hosts or in experimental animals, or induce malignant transformation of cells on culture are known as oncogenic viruses.

All retroviruses have an outer envelope consisting of lipid and viral proteins; the envelope encloses the core, made of other viral proteins, within which lie two molecules of viral RNA and the enzyme reverse transcriptase, an RNA-dependent DNA polymerase. The virions have a diameter of about 100 nm and, in thin section, differences can be seen in the appearance of the core; those with a central condensed structure are known as type C particles while those with an eccentric bar structure are type D particles.

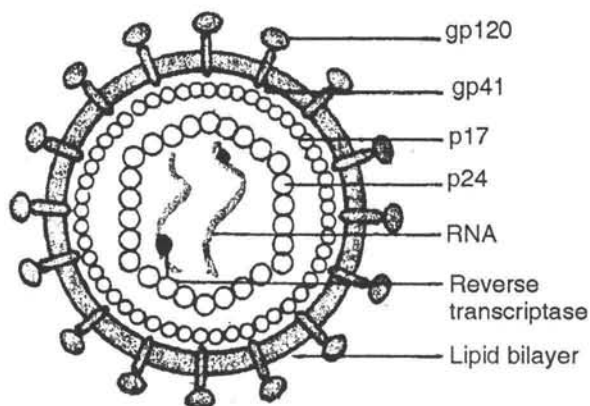

Fig. 7 : Electron micrograph of HIV

Resistance

HIV is a delicate virus. It is thermolabile being inactivated at 50°C in 10 min and in second at 100°C. It cannot survive outside the living host. However the live virus has been reported to survive within blood upto 8 days. It is susceptible to common disinfectants because of its lipid membrane envelope it is highly susceptible to detergents.

HIV is inactivated in contaminated medical instruments.

- heat, in the autoclave or hot air oven
- glutaraldehyde 2%
- hypochlorite (10,000 ppm); 1 in 10 dilution of domestic bleach
- other disinfectants, including alcohols.

The chemicals will inactivate at least 10^5 units of virus within a few minutes, but it is important to remember that disinfectants are inactivated in the presence of organic material.

The survival of HIV has been investigated. It has been shown that:

- ☆ virus may survive for upto 15 days at room temperature.

- ☆ at 37°C virus can survive for 10-15 days
- ☆ over 60°C virus is inactivated 100-fold each hour.

These are the limits of survival. However, the results underline the need for cleanliness and disinfection when dealing with blood and infected secretions.

Classification

The family Retroviridae was originally divided into the sub families Oncovirinae, Spumavirinae and Lentivirinae, based on their biological properties and appearance in cell cultures. However the availability of nucleotide sequences from a large number of human and animal retroviruses has indicated that viruses referred to as oncoviruses belong to several distinct groups. In the new classification of retroviruses there are five groups, including two corresponding to the original lentiviruses and spumaviruses, a group containing HTLV-1 and II and the B/D group that contains a number of oncogenic viruses from other animals.

The human viruses HTLV-1 and HTLV-II are related to the simian viruses STLV-1 and II that are widely distributed in old and New world monkeys. In common with HTLV-I, they can cause lymphomas in some primates.

Morphology

HIV is a spherical enveloped virus, about 90-120 nm in diameter with a three layer structure. In the centre are two identical copies of ssRNA (9.2 kb each) associated with reverse transcriptase and surrounded by an icosahedral capsid, which in turn is surrounded by a matrix protein followed by a host cell membrane derived lipid bilayer envelope from which project 72 glycoprotein peplomers. The genome organization is similar for all retroviruses in that their genomes contain in the same order the genes gag, pol and env, which code for the three groups of structural protein. The long terminal repeat sequences (LTR) at both ends of the genome contain promoter and enhancer sequences. There are important differences between the types in the nature and arrangement of the genes involved in the regulation of the replication cycle. The genome of HIV contains three major genes each coding for two or more polypeptides. The gag (group specific antigen) gene encodes the core or capsid and matrix proteins, the pol gene encodes the reverse transcriptase (polymerase) and the env gene encodes the virion envelope peplomer protein and transmembrane protein. HIV-1 is divided into 3 groups. HIV-1M (major group), HIV-10 (outlier) and HIV-1N (new virus). HIV-1M comprises eight sub types or clades, designated A, B, C, D, F, G, H and J as well as four major circulating recombinant forms (AE, AG, AGI, AB) India predominantly has HIV-1M sub type C. Sub types A and B are less frequent. However western developed countries have HIV-1M sub type B as predominant sub type. Sub type C is usually acquired by heterosexual contact and subtype B by homosexual contact. HIV-2 has been divided in 5 sub types (A to E). There are at least six regulatory genes in HIV and at least two in HTLV-1. In HIV, tat codes for a protein that has a general stimulating effect on the synthesis of all viral proteins through its binding to a region in the LTR that promotes transcription of viral mRNAs. The rev gene product has a regulatory effect, switching on viral protein synthesis by favouring the production of full-length RNA molecules rather than the spliced RNA from the regulatory

genes. There is evidence that the product of other transactivating genes such as that of cytomegalovirus, can also act on the same sequence within the LTR of HIV. The four proteins coded for by the gag gene of HIV are all found in the virion. The pol gene products are a protease, endonuclease, integrase and reverse transcriptase. The env gene codes for a large protein that is glycosylated and cleaved to gp 41, the transmembrane protein and gp 120, the external envelope glycoprotein present on the envelope as a trimer with many glycosylation sites. Both HIV-1 and -2 show considerable sequence variability, which has allowed their classification into a number of sub types that show marked difference in geographical distribution and association with different risk groups. HIV variants are currently classified into at least eight subtypes (A-H) that differ from each other by 20-30% in nucleotide sequence. In addition, in areas with more than one subtype in circulation, viruses with recombinant genomes have been described.

Replication

Retroviruses differ from other RNA viruses in that they replicate and produce viral RNA from a DNA copy of the virion RNA. The best studied method of attachment of HIV to cells is by the interaction of the external envelope glycoprotein gp 120 with part of the CD4 molecule of T helper lymphocytes and other cells. Attachment is followed by interaction of the HIV envelope with a second (co-) receptor. Membrane proteins used by HIV-1 and -2 in this second step include the chemokine receptors, CCR5 and CXCR4. These are expressed on a wide range of lymphoid and non-lymphoid cells, whose ligands are chemotactic cytokines such as macrophage inflammatory protein -1 α involved in inflammatory responses. After this second binding step, entry of the virus occurs by fusion of the viral envelope with the cellular membrane, a step that requires exposure of a hydrophobic domain in gp 41. Once the RNA is released into the cytoplasm, the reverse

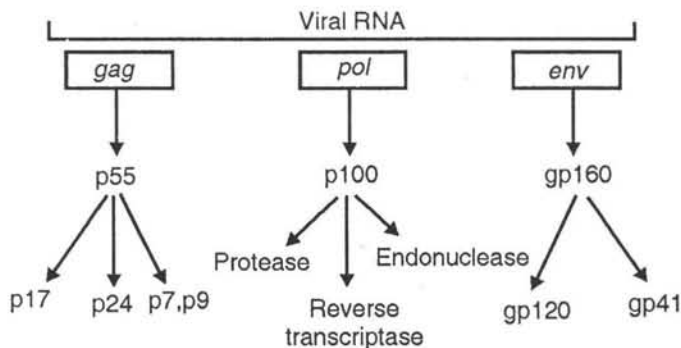

Fig. 8 : The genomic organization of HIV structural genes and their protein products

transcriptase acts to form the double-stranded DNA copy, which is circularized, enters the nucleus and is spliced into the host cell DNA. Once inserted into the host DNA, infection with HIV is permanent. The virus may stay latent or enter a productive cycle. Transcription of mRNA from the provirus is by the host RNA polymerase to produce viral mRNA and RNA. Proteins are synthesized and processed to form the virion components. Virions are assembled at the cell membrane where envelope and core proteins have located.

The internal structure of the virion matures as the virion buds from the cell. In the productive growth cycle the host cell is destroyed.

HIV and AIDS

In contrast to HTLV-I, a great deal is known about the association of HIV with disease.

Acute HIV infection: 2-6 weeks after infection most patients develop acute-onset fever with or without night sweats, malaise, headache, myalgia, arthralgia, lethargy, diarrhoea, depression, sore throat lymphadenopathy, skin rash, mucocutaneous ulcerations and sometime meningoencephalopathy. Spontaneous resolution occurs within one months. There is temporary fall in $CD4^+$ and $CD8^+$ cells followed by $CD8^+$ lymphocytosis. Test for HIV antibodies are usually negative at the onset of the illness but become positive during its course. Therefore acute HIV infection is also known as seroconversion illness.

(1) The acute seroconversion illness resembles glandular fever, with adenopathy and flu-like symptoms. Although most patients will experience some symptoms, only 5-10% show the full picture. Even fewer have the rare encephalitic presentation.

(2) Asymptomatic infection: All persons infected with HIV, wheather they develop seroconversion illness or not past through a long asymptomatic period of 1-15 yrs (Average 10 yrs). They show positive HIV antibody tests during this phase and are infectious. However autoimmune conditions like Guillain Barre Syndrome, chronic demyclinating neuropathy, idiopathic thrombo cytopenia, Reiter's Syndrome, polymyositis, Cranial nerve palsy may occur during this period.

(3) Persistent generalized lymphadenopathy (PGL) is present in 25-30% of patients who are otherwise asymptomatic. The enlarged lymph nodes are painless and symmetrical in distribution. The rate of progression of patients with PGL to AIDS is no greater than in those without adenopathy.

(4) The acquired immune deficiency syndrome (AIDS) presents in many ways, all due to the underlying severe loss of the ability to respond to infectious agents and to control tumours. The features classified as group IV include what was known as the AIDS-related complex or ARC. This label was applied to patients with constitutional symptoms. Following features indicate disease progression:

- (i) Downward trend of $CD4^+$ T cells in successive samples.
- (ii) The ease of virus culture
- (iii) The presence of P^{24} antigen in the plasma.
- (iii) The loss of antibody to P^{24} antigen

When $CD4^+$ T cell count falls below 400/wL, the patient may develop constitutional symptoms like fever, weight loss and diarrhoea and minor opportunisitic infections. Without treatment, such patients will progress rapidly to AIDS. The clinical features of AIDS are varied and reflect the specific agents involved: a diagnosis is made if the conditions listed in table are present here.

Oral hairy leucoplakia appears to be unique to HIV-infected patients. The margins of the tongue show white ridges of fronds on the epithelium. An association with Epstein-Barr virus and papilloma viruses has been proposed.

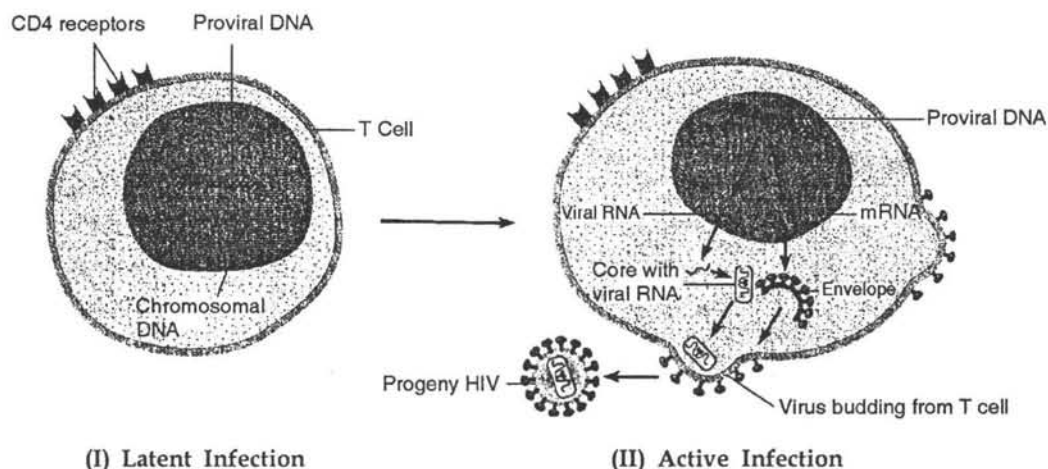

Fig. 9 : Stages of infection with HIV

TABLE 6

Classification of HIV infection and AIDS (Communicable disease center, USA)

Group I	Seroconversion illness (Acute HIV infection or HIV)
Group II	Asymptomatic
Group III	Persistent generalized lymphadenopathy
Group IV	A-Constitutional disease
	B-Neurological disease
	C-Secondary infectious disease
	D-Secondary cancers
	E-Other conditions

TABLE 7

Group IV disease (Communicable Diseases surveillance centre, London)

Not Aids indicator disease

Zoster

Oral candidiasis

Oral hairy leucoplakia

Seborrhoeic dermatitis

Other infections-strongyloidiasis, nocardiasis, pulmonary tuberculosis

Constitutional symptoms

Peripheral neuropathy and myelopathy

Thrombocytopenia

Opportunistic infection and malignancies commonly associated with HIV infection

I. Bacterial

1. *M. avium* complex - Common in HIV disease associated with advance stage of HIV disease ($CD4^+$ T cells $< 50 / \mu l$)
2. *Mycobacterium tuberculosis* - disseminated or extrapulmonary- military tuberculosis involve CNS lymphatic system, soft tissue, bone marrow, liver ($CD4^+$ T cells $> 300 / \mu l$)
3. Salmonella - recurrent septicaemia in AIDS cases

II. Viral

1. Cytomegalovirus- major cause of morbidity and mortality in HIV disease ($CD4$ count $< 100 / \mu l$) lead to diarrhoea, weight less anorexia fever, colon ulceration, persistent rectal ulcers.
2. Herpes simplex virus - Both HSV-I and HSV-2 are common mucocutaneous infections like gingivitis, fever blister, intranasal, genital and perianal ulcerations.
3. Varicella-zoster virus - May occur at any stage of infection, present with vesicular/or ulcerative lesions.
4. Epstein - Barr virus - thought to induce benign epithelial thickening of oral mucosa known as oral hairy leukoplakia.
5. Human herpesvirus 6 - Possible cause of pneumonia in AIDS patient.
6. Human herpesvirus 8- Possible cause of kaposi's sarcoma in AIDS patient.

III. Fungal

1. Candidiasis - *Candida albicans* common in HIV patients, cause mucocutaneous candidiasis (oral oesophageal and vaginal), rare systematic candidiasis (every body organ).
2. Cryptococcosis - *Cryptococcus neoformans* most life threatening fungal pathogen. 5-8% of all HIV patients cause meningitis, pulmonary disease, myocarditis associated with heart failure.
3. Aspergillosis- 300 sps of *Aspergillus*. *A. fumigatus* cause worst disease cause allergic bronchopulmonary aspergillosis, intracavitary aspergilloma.
4. Pneumocystis carinii pneumonia- cause more frequent intrathoracic complication of HIV in Europe and America cause extrapulmonary infection.
5. Histoplasmosis- *Histoplasma capsulatum* relatively frequent in HIV patients.
6. Coccidioidomycosis - *Coccidioides immitis* is a common pathogen cause pulmonary infection associated with cavitation, bronchiectasis and bronchial fistulas and chronic infection of other organs like bones and meninges.

IV. Parasitic

1. Toxoplasmosis - *Toxoplasma gondii* major cause of morbidity and mortality in HIV patients cause encephalitis or focal neurological deficits.
2. Cryptosporidiosis- *Cryptosporidium parvium* cause self limiting diarrhoea, cause life threatening enteritis leading to mal absorption of gut.
3. Isosporiasis - *Isospora belli* causes severe protracted and debilitating diarrhoea.
4. Microsporidiosis - *Microsporidia* is important cause of opportunistic disease in HIV infection, transplacental transmission is common.
5. Generalized strongloidiasis

V. Malignancies

1. Kaposi's sarcoma - As CD4⁺ T cells count decline, malignant tumor develop, occur in homosexual man raised irregular lesion on mouth gut, lung and eye believed to cause by 1 herpes virus-8.
2. B cell lymphoma or non-Hodgkin's lymphoma - Patients with very low CD4⁺ T cells count develop B cell lymphoma or non-Hodgkin's lymphoma.

VI. Slim Disease - terminal state of HIV wasting syndrome, profound weight loss (>10% of body weight), chronic diarrhoea (> 30 days), chronic weakness (> 30 days)

TABLE 8
Efficiency of Different Routes of Transmission of HIV

Route	Efficiency
Blood transfusion	> 90%
Perinatal	13-40%
Sexual intercourse	
• Anal intercourse	1% per episode
• Vaginal intercourse	0.1% per episode
Intravenous drug use	0.5-1%

Hugging, putting cheeks together or dry kissing is safe. Infection is not transmitted by travelling in a bus or a train with an AIDS patient, sharing public telephone, toilets, cooking and eating facilities or by the bite of mosquitoes, bed bugs or other blood sucking insects. Infection is not transmitted through air, food, water, fomites or by donating blood.

Urine, faeces, sweat, milk, bronchialveolar lavage fluid, amniotic fluid and synovial fluid have been reported to yield zero or a few HIV particles. Therefore, these are not important in HIV transmission. Saliva in adults contains some nonspecific inhibitory substances like fibronectins which can prevent cell to cell transfer of virus. This saliva is not a likely vehicle of transmission of HIV.

Replication of HIV

HIV attaches via its gp 120 envelope glycoprotein (surface spike) to the CD4 antigen complex which is the primary HIV receptor on CD4+ (helper/inducer) T lymphocytes and cells of the macrophage lineage. The CD4 molecule has binding avidity for gp 120 of HIV. Then by pinocytosis, the nucleocapsid of the virion enters into host cell. The envelope of the same does not enter into the cell. After entry into the cell, the nucleocapsid releases its RNA into the cytoplasm. The viral reverse transcriptase, acting as an RNA dependent DNA polymerase, makes a DNA copy of the genomic RNA. The ssDNA is made double-stranded by the same enzyme, now acting as a DNA-dependent DNA- polymerase.

This dsDNA moves to the nucleus and several such molecules become integrated as provirus at random sites in the host cell chromosome causing a latent infection. The integrated provirus is transcribed by cellular RNA polymerase II either for the production of mRNAs which are translated into proteins or for the production of genomic RNA for insertion into progeny virions.

HIV establishes a latent infection with or without an initial productive phase. In this state, the integrated proviral DNA remains silent without transcription or expression of most viral proteins. Certain factors, however, can activate the virus and convert the latent state into productive HIV infection. During viral replication, naked virus buds from the surface of the infected cell and acquires a lipoprotein envelope which contains lipid derived from the host cell membrane and glycoproteins which are virus-encoded.

Pathogenesis

Since HIV infects cells expressing CD4 antigen, therefore, in the circulation the virus is found in CD4+ T lymphocytes and also in monocyte-macrophage cells, which may act as a reservoir for virus. Macrophage are also important in carrying the virus into the central nervous system across the blood-brain barrier. Virus is also present in the plasma. It is probably derived from the lysis of activated lymphocytes. Within one month or so, viraemia declines to a near undetectable level and illness subsides. This is brought by CD8+ cytotoxic T lymphocytes, natural killer (NK) cells and antibody-dependent cell-mediated cytotoxicity (ADCC).

This is followed by a long asymptomatic period of 1-15 years (average 10 years). During this period, only a small number of circulating CD4+ cells are producing virus and only low titres of virus are present in the blood. However, many infected cells can be detected in the lymph nodes. Follicular hyperplasia develops in these and other lymphoid organs. When CD4+ T cell count falls below 400/ μ L, a large number of virions spill over from the degenerating lymph nodes into the blood and opportunistic infections with various microorganisms may develop. Cause of death is the opportunistic infections, malignancy and cachexia-like state. Fall in CD4+ T cell count is due to:

1. Viral cytolysis of CD4+ T cells.
2. Infected CD4+ T cell can fuse, via. gp 120, with up to 100 uninfected CD4+ T cells forming a unit called syncytium. This will lead to the death of the entire unit.

3. Immune cytolysis of infected T cells by cytotoxic T cells, NK cells, ADCC and antibody/complement-mediated lysis.
4. HIV may also infect stem cells, so that there is no replacement.
5. AIDS may be a autoimmune disease, causing autoimmune destruction of infected CD4+ T cells.

The helper cells (CD4+ T cells) provide positive signal to B cells so that they can produce specific antibody and cytotoxic or suppressor cells (CD4+ T cells) suppress the unwanted production of antibody by B cells. The pathogenic mechanism of HIV may be summarized as under:

1. Diminished positive signal to B cells resulting in poor production of specific antibodies. This ultimately results in different types of bacterial infections in AIDS cases.

2. Diminished signal to cytotoxic or suppressor T cells resulting in defective killing of intracellular virus. This ultimately results in failure to eliminate HIV and other associated viral infections.

3. Diminished signal to NK cells causing impaired defence against tumours. This ultimately results in increased prevalence of tumours eg. Kaposi's sarcoma.

4. Diminished signal to macrophages resulting in impaired killing of organisms within macrophages. This ultimately results in infections by organism like *Toxoplasma gondii*.

5. Diminished response to skin reactivity because of the non-availability of helper T cells at the site of injection of antigens resulting in little release of mediators and poor response to skin test antigens.

6. HIV can also infect:

- (i) Monocytes
- (ii) Macrophages leading to opportunistic infections such as tuberculosis and toxoplasmosis.
- (iii) Microglia, neurons, capillary endothelial cells, oligodendrocytes and astrocytes in the brain leading to the diverse CNS manifestations of AIDS.
- (iv) M (membranous) cells and enterochromaffin cells in intestinal mucosa leading to chronic diarrhoea and malabsorption.

Since most of the above cells lack CD4 antigen, HIV may be able to utilize alternative receptor.

Kaposi's sarcoma was one of the earliest diseases used to define AIDS. This rare tumour had been known for many years; it usually occurred at a single site and was not aggressive. In AIDS patients the tumour arises in many sites, including the skin, mouth, gut and eye. The tumours arise from endothelial cells of blood vessels, causing bluish-purple, raised irregular lesions. The aetiological agent is thought to be human herpesvirus 8. The tumours were seen only in homosexual men, the incidence has now declined.

Pneumocystis carinii pneumonia was another presentation found in many of the first patients recognized. This opportunist pathogen was known to cause infections in the

immunocompromised, but the diagnosis in young men with no explanation for their immunosuppression was the first clue to the recognition of AIDS.

Toxoplasma gondii infections can manifest at various sites, but are always associated with compromised patients. The brain is an important site.

HIV dementia develops in 25% of patients with AIDS and is marked by a gradual loss of cognition, progressing to overt dementia. Brain scans show a loss of tissue, with widening of sulci and ventricles.

In developing countries many of the same infections are seen but there is an emphasis on local problems. *Mycobacterium tuberculosis* infections are an enormous problem in many regions, with the development of strains of the organism resistant to many antibiotics. Many patients show profound weight loss, perhaps accompanied by chronic diarrhoea; the term slim disease has been given to this presentation.

Paediatric AIDS cases suffer from many of the problems of adults. However, children infected early in life or at birth are at risk of recurring bacterial infections as they have never acquired immunity to the organisms. Lymphoid interstitial pneumonia and pulmonary lymphoid hyperplasia are presentation seen only in young children.

Pathogenesis of HIV Infection and Aids

AIDS is unique sexually transmitted disease without local genital manifestations at any time during infection but with grave systematic manifestation. The first cell to become infected may be resident tissue macrophages or sub mucosal lymphocytes in the genital tract or rectum. The virus is then transported to draining lymph node where it replicates extensively 2-3 weeks after infection most patients develops viraemia, fall in CD4+ T lymphocytes and glandular fever like illness. The incubation period in the acute stage is from 1 to 2 months. This is preceded by a period of intense, unrestrained viral replication, reflected in the presence of high numbers of viral RNA genomes and p24 antigen in the circulation. After entering the body, virus is taken up by cells such as dendritic cells that carry the viral receptors. Within 24-48 h infected cells are present in the regional lymph nodes; virus can be detected in the blood and circulating lymphocytes by 5 days. As the immune system responds, both p 24 antigen and RNA copy number decrease, so that by 6-12 months p24 antigen is usually undetectable and the RNA load has stabilized at a lower level; in some it may be undetectable. The decline in RNA copy number is usually by at least 3-4 \log_{10} , and the effectiveness of the immune system in controlling virus replication at this time forecasts when the virus will escape control and symptoms appear. Temporary increases in the RNA level can be seen during intercurrent infections, immunizations and pregnancy.

Patients with AIDS are profoundly immunosuppressed. It was recognized early that the ratio of T helper to cytotoxic T cells (CD4:CD8) was markedly reduced. In fact, the ratio is upset in the acute stages, but is restored as the patient's response controls the virus.

In peripheral blood, lymphoid tissue and other tissues such as brain where HIV replication occurs, HIV targets CD4 positive (CD4+) cells and cells of the

monocytemacrophage lineage; the latter may act as an important reservoir of virus. Macrophages are also important in carrying the virus into the central nervous system across the blood-brain barrier.

The proportion of infected CD4⁺ cells and the level of circulating virus rise as the infection progresses, reflecting increasing virus replication until the patient becomes symptomatic. Activation of latently infected lymphocytes can be achieved by contact with foreign antigen and lectins such as phytohaemagglutinin. Activation of uninfected CD4⁺ cells is also important in increasing their sensitivity to infection.

Destruction of CD4⁺ cells is caused by:

- viral replication
- syncytium formation via membrane gp 120 binding to cell CD4 antigen
- cytotoxic T cell lysis of infected cells
- cytotoxic T cell lysis of CD4⁺ cells carrying gp 120 released from infected cells.
- natural killer cells
- antibody-dependent cell cytotoxicity

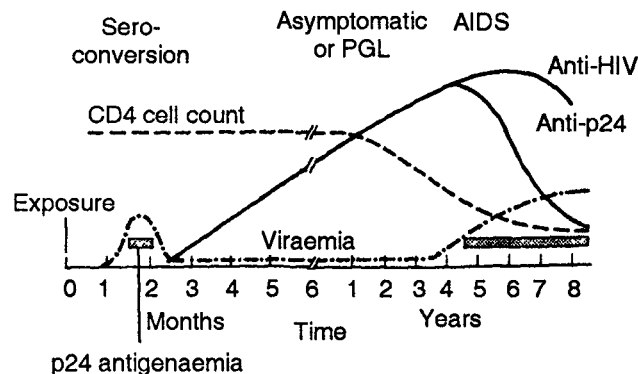

Fig. 10 : Events in HIV infection

Analysis of the viral genomes from a patient shows that there are several different viral genomes present at any time and that these change with time. Virus isolated in culture may be different from the predominant variants in the blood. Viruses isolated in the later stages of infection have been shown to grow more rapidly, to higher titres and to form syncytia (giant cells) more readily than virus isolated in the early stages. Regions of the envelope glycoproteins show most variation and this could affect the ability of antibody to react with the viruses. While this could be relevant to the progression of the infection, it has implications for the development of vaccines.

Laboratory markers associated with progression of HIV infection

Number of CD4 lymphocytes

Increasing proportion of infected CD4 cells

Increasing titre of virus in plasma (HIV RNA copy number)

P24 antigen in plasma

Isolation of virus in culture- rapid growth, syncytium formation, loss of antibody to p24

Elevated β 2- microglobulin level

Elevated serum neopterin level

Elevated serum soluble interleukin-2 level

Loss of cutaneous hypersensitivity

Paediatric Infection

In most cases, infection is transmitted to the baby in the perinatal period when the child's immune system is immature. This results in a major difference from the picture seen in older children and adults in that the initial replicative phases is not limited by the immune response and high levels of viral RNA persist. The RNA counts are often more than 100 000/ml at 2 months. About three-quarters will show a steady decline thereafter of $0.6 \log_{10}$ each year; however, by age 9-16 years, a third are still asymptomatic and show little impairment of immune function. The other quarter of the children have high levels of viral RNA and develop early onset disease and death by 20-24 months. The mother often has advanced disease during the pregnancy and some of these children may have been infected before birth. It has been suggested that this group of rapid progressors can be identified by detection of virus by RNA polymerase chain reaction (PCR) and culture within 48 h of birth. Analysis of the child's RNA can show that it differs from that of the mother, suggesting that replication has occurred by the time of sample collection or that a minor maternal variant has been transmitted to the baby.

LABORATORY DIAGNOSIS

Laboratory tests for the diagnosis of HIV infection

1. Screening (E/R/S) tests

(a) ELISA

(b) Rapid tests

- Dot blot assays
- Particle agglutination (gelatine, RBC, latex, microbeads)
- HIV spot and comb tests
- Fluorometric microparticle technologies

(c) Simple tests

- Also based on ELISA principle but take 1-2 hours

2. Supplemental tests

(a) Western blot assay

(b) Immunofluorescence test

3. Confirmatory tests

- (a) Virus isolation
- (b) Detection of p24 antigen
- (c) Detection of viral nucleic acid
 - (i) In situ hybridization
 - (ii) Polymerase chain reaction

Various tests are used in different circumstances. Thus, to date the main approach to the diagnosis of infection in patients and for screening populations, e.g. blood donors, has been by testing for anti-HIV. However, when serological tests are inappropriate, such as during the early acute stage and in infants who still carry maternal anti-HIV, direct detection methods are required. By 1988, pattern changed and more specific tests were developed based on recombinant antigens (second generation) and synthetic peptides as antigen (third generation). The sensitivity and specificity of ELISA is 99.7% and 95% or more respectively. If one ELISA and western blot is used then accuracy is 99.99%.

Tests for anti-HIV

This was the first practical approach and many different assays are now available, most using enzyme tracing of the reaction (enzyme-linked immunosorbent assay; ELISA). All current tests use HIV antigens derived from cloned recombinant HIV gag, pol and env genes expressed in *Escherichia coli*, or synthetic peptides. Western or immunoblotting has been used extensively as a confirmatory assay. Most current assay can detect antibody to both HIV-1 and HIV-2 antigens. A first positive result must be confirmed by at least two other different assays with different viral antigens, and a second serum sample checked to confirm that the original sample was correctly identified.

As all who are infected with HIV remain so, a positive test for anti-HIV indicates that the patient is infected. Most patients will seroconvert within 2-3 months but some may take longer. Thus there is a window before antibody tests can detect infection.

PCR

Both HIV RNA and DNA sequences can be detected by PCR. RNA sequences are found in extracellular virus particles in plasma. Levels of RNA can be assayed as copy number and indicate the extent of virus replication in the patient. Measurement of plasma virus load is now essential for monitoring disease progression and response to antiviral therapy. A number of commercial assays have been developed, e.g. the Roche monitor™ and Bayer Nuclisens™ assays, to provide accurate and standardized viral load measurements in clinical laboratories.

HIV proviral DNA is synthesized in infected cells, and can be detected readily in peripheral blood mononuclear cells of infected individuals. This method is principally used to diagnose infection in infants born to HIV-infected mothers. As infection is often acquired perinatally, a negative test result at 3 months or later is required to exclude infection. In horizontally transmitted infections, detection of proviral DNA can be used

to diagnose an acute infection before seroconversion, although detection of plasma viral RNA is more often used.

Tests for p24 antigen

P24 antigen is part of the virion core and it can be found in the blood when there is active viral replication. Antigenaemia is usually of short duration at the time of initial infection, and may not be detected in all cases. As the antibody response builds up antigen tests become negative. However, late in infection, p24 antigen may reappear until most patients give a positive result. Tests for p24 antigen are now used less often since the introduction of PCR assays for viral RNA load estimation for monitoring disease progression. Similarly, p24 antigen detection is rarely used for the diagnosis of acute infection before seroconversion for antibody, or detecting infection in neonates.

Immunofluorescence test

In this test HIV infected cells are acetone fixed on to glass slides and then reacted with test serum followed by fluorescein conjugated anti human gammaglobulin. A positive reaction appears as apple green fluorescence of cell membrane under fluorescence microscope.

Virus isolation

Isolation of HIV is slow, taking from 3 to 6 weeks. The usual sample is blood, from which the lymphocytes are separated and co-cultured with phytohaemagglutinin-stimulated donor lymphocytes. Virus presence is detected by assays for reverse transcriptase and p24 antigen in the culture fluids. With the advent of PCR, there are now few, if any, diagnostic uses of virus isolation.

HTLV-1

Assays for the detection of antibody to HTLV-I are available; as with HIV, confirmation by other assays or immunoblot must be attempted, although interpretation can be difficult. Confirmatory tests are able to distinguish between HTLV-I and HTLV-II. Detection of HTLV proviral sequences by PCR can also be used as a confirmatory test, and to distinguish HTLV-I and HTLV-II.

Treatment

HTLV-1 Infection

Interferon and inhibitors of reverse transcriptase may have a role, but further evaluation is needed.

HIV infection and AIDS

Specific therapy for HIV infection has been available for some years since the inhibitory effect of zidovudine on the viral reverse transcriptase (reverse transcriptase inhibitor, RTI) was discovered. It was established that zidovudine therapy could lead to

an improvement in the patient's health, with weight gain, a reduction in viral load and partial recovery of CD4⁺ cell numbers. However, the improvement seldom lasted longer than 6 months, as drug-resistant mutants were selected. A similar response is seen with other RTIs used along. More recently, a second point of attack against HIV has been exploited with the development of drugs active against the viral protease.

The major advance has come with the application of combination therapy, where RTIs are given with protease inhibitor. At present, the compounds available are:

- nucleoside analogue RTIs: zidovudine; didanosine (ddI); abacavir; zalcitabine (ddC); stavudine; lamivudine
- non-nucleoside RTIs: nevirapine; delavirdine; efavirenz
- protease inhibitors; indinavir; ritonavir; nelfinavir; saquinavir; amprenavir.

Initial therapy is now a combination of two RTIs and a protease inhibitor. A typical combination is:

- zidovudine 200 mg three times a day
- lamivudine 150 mg twice a day
- indinavir 800 mg three times a day or nelfinavir 750 mg three times a day.

It is essential that the drugs are started together and that the regime is adhered to strictly. It is important to know if the drugs have been used before by that patient and if the patient is infected with drug-resistant virus. Each drug should be given at its optimum dosage and schedule. If a drug is to be replaced because of prior use, known resistance or development of resistance, an alternative should be chosen that does not show cross-resistance with the drug being replaced.

It is important to continue with the prophylaxis and prompt treatment of opportunistic infections such as *Pneumocystis carinii* and *Toxoplasma gondii*. Some patients have problems with compliance to the drug regime and some suffer significant side-effects. About 50% of those on long-term therapy will suffer a redistribution of body fat the lipodystrophy syndrome. Many patients have been treated for years with a good quality of life as a result of these advances. The major problems is the emergence of resistance.

Transmission and Epidemiology

HTLV-1 and HTLV-II

The three lineages of HTLV-I strains are linked to Melanesia, to central Africa and to various countries, the cosmopolitan group. The latter includes viruses from Japan, North and West Africa and the Caribbean, which can be distinguished. HTLV-I and the simian virus, STLV-I are closely related and it is proposed that human infection occurred many thousands of years ago in Africa and that the presence of the virus in many different parts of the world is related to the migration of ancient peoples. The slave trade may account for foci found in the West Indies and the southern USA.

Where it is found the virus is endemic in certain communities. In parts of Japan, the prevalence of antibody can be 27%, with a rising trend from 7 to 8% in the 20-39 years age group to 52% in females and 32% in males by 80 years. In the Caribbean, the

rates are in the range of 5-10% with clusters in communities and families. In other regions, infection has been found in parenteral drug misusers and prostitutes.

The virus is cell-associated in the host, so transmission will occur when infected cells are transferred. This can occur during intercourse. Breast milk is also a source. Transfer of infected lymphocytes during blood transfusion and sharing injecting equipment by drug misusers are other recognized routes.

HTLV-II is transmitted by the same routes. The strains found in drug misusers in different countries are related.

Transmission of HIV-1 and HIV-2

The World Health Organization estimates that worldwide more than 40 million people have been infected with HIV and that 16 million have died.

Virus is present in the blood, semen, and cervical and vaginal secretions, and these sources are important in transmission. Virus may also be present in cerebrospinal fluid (CSF), saliva, tears and urine, but at lower titres than in blood. There is no epidemiological evidence that these are significant sources for transmission. Free virus is present at high titre during the early stage of infection and increases in titre in the blood in the later stages of the disease; there is evidence of a greater risk of transmission from such patients.

To transmit, virus has to reach susceptible cells at the point of entry, e.g. Langerhan's cells in mucous membranes, or after entering the circulation.

The three important routes of transmission of HIV are:

- by unprotected, penetrative sexual intercourse
- from mother to child
- by blood and blood products.

Sexual Intercourse

Heterosexual transfer of virus is the route by which the great majority of infections are spread, accounting for 90% of the global total: most live in the developing world. Both sexes are affected equally. Overall the estimated risk of transmission from one unprotected exposure is 0.1-0.2% for vaginal intercourse. The probability of transfer is increased if either partner has ulcerative genital or other sexually transmitted disease. Any trauma during intercourse will also facilitate transfer, by allowing direct access of the virus to susceptible cells and the circulation. Sex workers are at high risk due to their large number of partners; they are often an important reservoir. Transmission may be more likely from male to female.

AIDS was first recognized in homosexual men in the USA. Most early studies established that unprotected anal intercourse was a particular risk, especially to the passive, receptive partner. The estimated risk from a single exposure is 0.1-0.3%.

Transmission during oral sexual contact has been documented, but is not a major route.

Mother to Child

Most perinatal transmission occurs late in pregnancy or during birth. The most likely source is cells and virus in the cervix and vagina, as the baby passes through the birth canal. The risk of transmission varies from 13 to 32% in the developed world to 25-48% in the developing world. Prolonged and difficult labour is a factor. Breast milk is another possible source. It is difficult to be precise about the contribution of this route, but estimates ranging from 14-30% have been made.

Blood and Blood Products

All blood for transfusion and the preparation of products such as factor VIII for haemophiliacs is screened for anti-HIV by sensitive assays. This eliminates almost all the risk, but as there is a delay of some weeks before the tests become positive, it is important to screen donors for possible exposure to risk. Preparation of blood products from large pools of donations was a major factor in contaminating the product as even one infected donation could introduce virus to all the material. Transplanted organs have been implicated in a few cases.

Intravenous drug misuse is a risk factor in about one-quarter of AIDS cases in the USA and to a varying extent elsewhere in the world. The risk rises with the volume of blood injected and the frequency of sharing contaminated equipment. The withdrawal of blood before injection increases contamination. The virus can spread very rapidly so that most misusers in an area become infected in a few months. Those infected in this way can spread the virus to their sexual partners. Drug and sexual routes merge when misusers support their habit by prostitution.

Occupational exposure of health care workers to infected patients has resulted in transmission in a relatively small number of cases. The route is via accidental penetrating injuries with needles and sharps contaminated with blood. The risk from a needle stick is 1 in 200-300; up to 1998, less than 200 instances had been established or suspected in North America and Europe. Contamination of eyes and mucous membranes is another possible route, but this is seldom confirmed. Transmission from health care workers to patient has been suspected in only a few cases.

HIV-2 is transmitted by the same routes as HIV-1.

The majority of infected individuals have a recognized exposure to a known source of infection. In some this may be difficult to establish. However, there is no evidence that HIV can spread by casual contact and by inhalation.

Studies of people exposed to the virus on many occasions have shown that a few show no evidence of infection, and remain negative for anti-HIV. The resistance of these individuals is of great interest to understanding protective immunity.

Epidemiology of HIV

The extent of spread of infection can be measured by the numbers of cases identified clinically and by serological testing. Much more evidence can be obtained from seroprevalence surveys of particular groups or the general population. The availability

and collection of samples impose limits. Surveys have been performed on patients attending hospitals antenatal clinics, sexually transmitted disease clinics and blood donors. Specific groups such as drug misusers and prostitutes can be targeted, non-invasive sampling, e.g. collecting saliva, may make these studies more feasible. Repeat testing over time will give an indication of the trend of infection in that population. Such studies are important in monitoring the effect of intervention strategies and forecasting the demand for health services.

HIV was isolated in the early 1980s but the first identified cases date to the 1960s. During the 1970s, the virus began to spread widely in some populations and groups by the routes described above.

In North and South America, Europe and Australia, at least 30-40% of cases are in gay men. Parenteral drug misusers are the other major risk group in these areas. Virus of sub type B is closely associated with these groups and accounts for at least 50% of all infections. The other cases are in the heterosexual partners of bisexual men, drug misusers and men and women from other areas of the world. Infected blood caused some cases before screening was introduced. The estimated prevalence in the population is from 0.05 to 0.35%. with less than 0.01% in antenatal patients. The numbers of infections in risk groups can change as health education programmes are introduced; however, their success can vary and advice may be ignored if the perception of risk changes. There have been 1.4 million deaths so far in these areas.

Regions of Africa have suffered the greatest epidemic spread of the virus, particularly in most of the countries of the sub-saharan region. It is estimated that 60% of the world total of infections are in this area. Population prevalences range from 1.5 to 18%, with 2-40% of antenatal patients infected. The viruses circulating here are of sub types C, A, D and E. Of these, C has spread rapidly and now accounts for 50% of all infections. There is some evidence that subtype C may be able to transmit more easily by heterosexual contact than subtype B, due to its greater affinity for the receptors of Langerhan's cells.

Almost 90% of AIDS deaths have occurred in Africa (13.7 million). The virus continues to spread, and there were an estimated 3.8 million new infections in 1999. The social and economic consequences of this epidemic are devastating, with the loss of parents and wage earners. The high infant mortality will have profound effects in the future.

HIV was introduced into South and South-east Asia later than in the rest of the world, and so far there have been 1.2 million deaths from AIDS. Infection is spreading rapidly, with an estimated 1.3 million new infections in 1999. The earliest infections were in drug misusers, but this did not lead to wide spread outside the risk group. The situation changed with the introduction of sub type C virus, and there is now rapid heterosexual transmission of this strain. Prevalences from 0.45 to 3.5% have been effective, with 1-10% in antenatal patients, without effective intervention large numbers of cases and deaths will occur, with all the expected human and socio-economic consequences. Throughout the region, sub types A, B, C, D and E have been found.

As a result of the wide circulation of different sub types in some populations, recombinant viruses have been identified. AC and AD recombinants have been found.

Studies in Tanzania suggest that 15% of the virus population in the country is recombinant and that these viruses can be transmitted. A few recombinants have been isolated from areas in the East.

The existence of different sub types of HIV, and recombinants, is important for two reasons. Firstly, assays for anti-HIV and viral nucleic acid must be able to recognize all types. Secondly, vaccine developers must take account of the various types and establish the spectrum of protection of candidate vaccines.

CONTROL

Sexual Transmission

Until a vaccine is available, the emphasis in controlling the spread of infection must be on risk reduction by avoiding unprotected penetrative intercourse with partners of unknown status. Despite knowledge of the major routes of infection, there has only been limited success in reducing sexual transmission. Globally the problem is enormous and efforts are hampered by the poverty and lack of resources of the countries worst affected. The use of condoms and vaginal antiseptics could have an impact, but they need to be available and acceptable to the local population.

In the areas of the world with low levels of infection early efforts to encourage safe practices had an effect on the spread of the virus among gay men in the Americas and Europe, but this was not always maintained as the perception of the risks changed as a result of declining rates of infection and, more recently, as the latest therapies appeared to be succeeding and prolonging survival. Also, it is difficult to persuade the heterosexual majority that safe practices are relevant to them.

Mother to Child Transmission

This can be reduced by identifying infected mothers & giving specific therapy in the later stages of pregnancy and to the baby after birth. It has been shown that zidovudine alone can reduce the transmission rate by a factor of three if given:

- Orally to the mother from weeks 14 to 34 of the pregnancy.
- Intravenously to the mother during labour pain.
- Orally to the child for 6 weeks after delivery.

If the mother is already being treated, zidovudine should be part of her treatment, even if she has had it before, transplacental transfer of the drug is important, perhaps aided by phosphorylation of the drug in the placenta. Most transmissions are believed to occur close to, or during, delivery. Thus simpler treatment regimes may be effective. Oral therapy for the mother for 1 month during delivery and for a short period post-partum may halve the rate. Further studies are needed to establish the most appropriate regimes for the developing world.

As exposure to infected genital secretions is the source of the virus, avoiding prolonged rupture of the membranes before delivery can reduce risk. Caesarean section may have a similar effect, but is of limited applicability.

Breast-feeding is another possible route. However, studies of children protected by specific therapy at and after birth do not show that there is a significant extra risk of infection by this route. Even without therapy, the advantages of breast-feeding if no other adequate nutrition is available far outweigh any risk of infection where alternative nutrition is available, the baby may not be breast-fed.

Exposure to Blood

Drug injectors can avoid risk by not injecting, or can reduce risk by using only clean equipment. Screening of all blood donors should eliminate almost all possibility of transmission. Factor VIII and other blood products are heat-treated, if possible, to inactivate HIV. All organ donors must be screened.

Occupational risk in the health care setting can be controlled by the implementation of safe working practices to prevent accidental injury and contamination with blood and body fluids. The use of gloves, masks and eye protection is important in situations such as surgical procedures where bleeding and spattering are possible. The risk must be assessed in other situations. Safe disposal of used needles, scalpel blades and other sharps is an essential requirement. The sensitivity of HIV to heat and various disinfectants has been described above.

If an accidental exposure occurs, any wound should be washed with soap and water, or mucous membranes flushed with water. The accident must be reported so that, if necessary, prophylaxis can be started as soon as possible. The risk must be assessed through knowledge of:

- The HIV status of the source patient; if unknown, can the source be tested?
- Is the source on therapy for HIV? Any evidence of drug resistance?
- The nature of the exposure, e.g. injury or contamination of skin or mucous membranes.

Knowledge of the status of the source patient is essential. The patient may be known to be antibody-positive or to have AIDS. If on therapy, it is important to know the regimen, and if there is any evidence of drug resistance. The risk of infection from splashing on to mucous membranes or skin is harder to quantify, but is certainly less than with penetrating injuries. An intact skin is an effective barrier, but abrasions and diseases such as eczema may impair this protection.

If a sharp injury is reported the nature of the injury has to be assessed:

- needlestick or cut with sharp instrument
- depth of penetration
- volume of blood involved
- if blood vessel entered

If there is an indication of risk, therapy must be started within 1-2 h, and not later than 48-72 h. If no professional advice is available, e.g. at night, prophylaxis should be started and advice obtained and a decision made about continuing with the drugs within

12-24 h. The victim should be involved in the decision, with discussion of the risks and the possible side-effects of the drugs.

Zidovudine alone can reduce the transmission rate, but should now be combined with another RTI (e.g lamivudine) and a protease inhibitor. The combination of drugs can be varied with knowledge of any drug resistance in the source. Therapy should be continued for 4 weeks and the victim followed with testing for virus for the next 6 months. A few cases of transmission have been seen in cases prophylaxis.

TABLE 9
Currently Available Antiretroviral Agents

Nucleoside reverse transcriptase inhibitors (NRTIs)	Non nucleoside reverse transcriptase inhibitors (NNRTIs)	Protease inhibitors (PIs)	Integrase inhibitor
Zidovudine (azidothymidine)	Nevirapine	Ritonavir	Zintevir
Lamivudine (deoxythiacytidine, 3TC)	Delavirdine	Saquinavir	
Stavudine (didehydrodeoxythymidine, d4T)	Loviride	Indinavir	
Didanosine (dideoxyinosine, dDI)	Efavirenz	Nelfinavir	
Zalcitabine (dideoxycytidine, ddC)			
Amprenavir			
Abacavir		Tipranavir	

Exposure Code

Exposure to blood, body fluid, other potentially infectious material, or an instrument contaminated with one of these substances

No PEP required - No - Yes

Type of Exposure

Intact skin

Volume

Mucous membrane or skin integrity compromised

Percutaneous exposure

Small e.g. few drops or short duration - EC1

Large e.g. several drops, major splash or longer duration (several minutes or more)-
EC2

Less severe e.g. solid needle, superficial scratch - EC2

More severe e.g. large hollow needle, deep puncture, visible blood on device or needle used in patient's artery or vein - EC3

Vaccines

Much effort has been devoted to the development of a vaccine to provide protection against infection. By analogy with hepatitis B and other viruses, and understanding of the attachment mechanisms of HIV to cells, most emphasis has been placed on vaccines containing the viral env protein gp 160, gp 120 or gp 41 prepared by recombinant DNA cloning and expression, or as synthetic peptides known to be important epitopes for neutralizing antibodies. Several prototypes are undergoing evaluation.

POXVIRIDAE

(1) Introduction

The family Poxviridae contains two subfamilies, Chordopoxvirinae and Entomopoxvirinae which contain poxviruses of vertebrates and insects respectively. Chordopoxvirinae contains eight genera four of which, *Orthopoxvirus*, *Parapoxvirus*, *Molluscipoxvirus* and *Yatapoxvirus*, cause diseases in humans (Table) Pox viruses are largest virus that infect vertebrates and can be seen by light microscope.

TABLE 10
Poxviruses producing disease in man

Genus	Disease
Orthopoxvirus	- Small pox - Vaccinia - Buffalo pox - Monkey pox - Cow pox
Parapoxvirus	- Milker's node - Orf
Molluscipoxvirus	- Molluscum contagiosum
Yatapoxvirus	- Yabapox - Tanapox

2. Clinical features/Symptoms

The small pox virus had no animal reservoir and spread from person to person by the respiratory route. After infecting mucosal cells in upper respiratory tract without producing symptoms it spread to the regional lymph node and after a transient viraemia, infected cells throughout the body. Multiplication of virus in these cells led to a second and more intense viraemia which heralded the onset of clinical illness. During first few days of fever the virus multiplied in skin epithelial cells, leading to the development of focal lesions and characteristic rash. Macules progressed to papules, vesicles and pustules leaving permanent pockmarks particularly on the face. Two kinds of small pox were common in the first half of the 20th century. These were called:

(A) *Variola major*/classical small pox

(B) *Variola minor*/Alastrim

Variola major had case fatality rates varying from 10-50% in the unvaccinated *variola minor* caused a much milder disease and had case fatality rates of less than 1%. The viruses are very similar but can be distinguished in the laboratory by restriction enzyme fragment length polymorphisms of their genome. The last natural case of *variola major* detected was Saiban Bibi, a Bangladeshi woman found with small pox on Karimganj railway platform in Assam on 24th May 1975. The last case of *variola minor* occurred in Merca, Somalia in October 1977. The incubation period is around 12 days.

3. Morphology

Poxviruses are the largest animal viruses. They are large enough to be seen by light microscopy after special staining procedures. In most genera, the virions are brick-shaped with rounded corners, measuring 250 x 200 x 200 nm in size. They are known as complex viruses. Pox viruses have a biconcave dumb-bell-shaped DNA core and two lateral bodies enclosed in a protein shell about 12 nm thick. It is known as outer membrane, surface of which consists of irregularly arranged tubules. Virions released from the cells are enclosed within an envelope which consists of host cell lipids and several virus-specified polypeptides, including the haemagglutinin. Their DNA genome range in mass from 85 M Da (parapoxvirus) to 185 M Da (avipoxviruses). The vaccinia virus genome has 186,000 base pairs (123 MDa). The pox virus genome is distinct in that covalent links join the two DNA strands at both ends of the molecule, the genome thus being a single uninterrupted molecule that is folded to form a linear duplex structure. The characteristic feature is, identical sequences being present at each end of the genome.

4. Physical and Chemical Properties

Pox virus are stable and if protected from sunlight may remain viable for months at room temperature. In the cold or when freeze dried, they survive for years. They are susceptible to UV light and other irradiations. They are resistant to 50% glycerol and 1% phenol but readily inactivated by formalin or oxidizing disinfectants. The virion contains a multiplicity of enzymes and entire multiplication of virus takes place in the cytoplasm of infected cell. All pox virus share a common nucleoprotein antigen.

5. CONTROL OF SMALL POX

Before Vaccination

Before the introduction of vaccination, the control of small pox relied on two approaches, variolation and isolation. Variolators aimed to induce immunity equivalent to that after natural infection. Susceptible individuals were deliberately infected with smallpox pus or scabs by scratching the skin or by nasal insufflation. Although the virus was not attenuated, infections had lower case fatality rates and were less likely to cause permanent pock marks than those acquired naturally. Variolation was first recorded in China nearly 1000 years ago, and was practiced in many parts of the world. Variolators

were active until very recent times. In Afghanistan, Pakistan and Ethiopia their activities caused problems towards the end of the small-pox eradication programme in the 1970s because they spread virus in a way that evaded the measures erected to control natural virus transmission.

Vaccination

Edward Jenner vaccinated James Phipps with cowpox virus on 14 May 1796 and challenged him by variolation some months later. He repeated this 'trial', as he called it, in other children, and the description of these events in his 'Inquiry' in 1798 led to the rapid world wide acceptance of vaccination. Introduction of the vaccine virus into the epidermis led to the development of a local lesion and the induction of a strong immunity to infection with small pox virus that lasted for several years. Although the essentials of *Jennerian vaccination* remained unchanged for the rest of its history, early vaccinators developed their own vaccine viruses, which became known as vaccinia. The origin of these viruses is obscure, and modern vaccinia viruses form a distinct species of orthopoxvirus, related to but very clearly distinct from the viruses of both cowpox and smallpox.

Small pox was brought under control by:

1. routine vaccination of children-compulsory in some countries
2. Outbreak control by isolation and selective vaccination

This was achieved gradually in Europe, the former USSR, North and Central America, and Japan, and the virus had been eradicated from all these areas by the mid-1950s. In 1959 this achievement prompted the world health organization (WHO) to adopt the global eradication of smallpox as a major goal. At this time 60% of the world's population lived in areas where small pox was endemic. A slow reduction in disease was maintained for the next few years, but epidemics continued to be frequent. Consequently the WHO initiated its intensified small pox eradication programme. This started on 1st January 1967 when the disease was reported in 31 countries. It had the goal of eradication within 10 years. The goal was achieved in 10 years, 9 months and 26 days. From a starting point of 10 million to 15 million cases annually and against a background of civil strife, famine and floods, success came because of a major international collaborative effort-aided by some virus-specific factors. At the beginning of 1976 small pox occurred only in Ethiopia. Transmission was interrupted there in August of that year, although an importation of virus into Somalia and adjacent countries had occurred by then. This was the last outbreak. The last case occurred on 26 October 1977. In the final years of the programme its emphasis moved from mass vaccination to a strategy of surveillance and containment. This strategy rapidly interrupted transmission because:

- (i) cases were easy to detect due to the characteristic rash
- (ii) patients usually transmitted disease to only a few people-and only to those in close face-to-face contact.
- (iii) only person with a rash transmitted infection.

The WHO Global commission for the eradication of small pox formally certified that smallpox had been eradicated from the world on 9 December 1979. The use of smallpox as a biological weapon has been raised. It could be a severe threat in unprotected populations.

6. Other poxvirus diseases

With the elimination of smallpox, it has become important to identify and characterise other orthopoxviruses which can infect human beings and causes disease resembling smallpox (Table)

TABLE 11
Comparison of properties of some Orthopoxviruses

	Variola	Monkey pox	Vaccinia	Cow pox	Camel pox
Isolated from	Humans	Humans, monkey, anteater	Origin unknown	Humans, cow	Camel
Pocks on CAM	Small, white	Small, Pink	Large, white	Hemorrhagic	Small, white
Ceiling temperature on CAM(°C)	37.5-38.5	39	41	39.5	38.5
Growth on rabbit skin	-	++	+ or ++	+	+
Thymidine kinase sensitivity	+	-	-	-	-
Pathogenicity for baby mice	Low	High	High	High	Low
Antigens - Vaccinia	-	-	+	+	+
(specific for) - Variola	+	-	+	-	+
Monkey pox	-	+	-	-	-

Monkey pox: This virus was first isolated in 1958 from an outbreak of pox disease in a captive monkey colony in Copenhagen. Similar outbreaks have since been identified in other monkey colonies also. No simian outbreaks in nature have been recorded. The first human case was reported from Zaire in 1970. Several cases have been reported from Central and West Africa.

The cases clinically resembled small pox. However, person-to-person transmission appears to be rare. Serological studies have shown evidence of widespread natural infection in monkeys in Africa. The virus can be distinguished from variola.

Buffalo pox was identified in cattle in India in 1934 and was considered an outbreak of vaccinia in them. Epizootics had occurred in buffaloes and lesions had been observed on the hands of persons in contact with infected animals. Two decades after eradication of smallpox and cessation of vaccination, buffalo pox still occurs, proving it to be distinct, from variola and vaccinia. Though it resembles them closely, it is possible to distinguish between them and in the laboratory. Small pox vaccine does not seem to protect persons against occupational buffalo pox.

Cow pox and milker's nodes: Both these infections are obtained from cows. Cows pox lesions are seen on the udder and teats of cows and may be transmitted to humans during milking. The lesions in humans usually appear on the hands or fingers and resemble primary vaccinia. The disease is associated with some fever and constitutional symptoms. Cowpox virus resembles variola and vaccinia antigenically but can be differentiated by the hemorrhagic lesions it produces on CAM and rabbit skin.

Cowpox infection has been observed only in Britain and Europe. There have been outbreaks of fatal cowpox infection in wild animals kept in zoos, including cheetahs and elephants. Natural infection has been observed in domestic cats. It has been suggested that the primary host of cowpox may not be cows but more likely wild rodents or cats.

Milker's node (paravaccinia) is a trivial occupational disease that humans get by milking infected cows. The lesions are small ulcerating nodules. The virus is unrelated to cowpox and does not grow in eggs. It can be grown in bovine kidney cultures. It resembles the orf virus morphologically.

Orf (contagious pustular dermatitis): Orf is a disease of sheep and goats transmitted to human beings by contact. In humans, the disease occurs as a single papulovesicular lesion with a central ulcer, usually on the hand, forearm or face. The virus is unrelated to the variola-vaccinia group and resembles paravaccinia virus morphologically.

Tanapox: This virus was isolated from epidemics of a febrile illness along the Tana river in Kenya in 1957. The patients had a single pock-like lesion on the upper part of the body. The virus is antigenically unrelated to other pox viruses and does not grow in eggs. It can be grown in human and monkey tissue cultures. Monkeys are the only animals susceptible. The virus is now active in Africa, particularly in Zaire. A similar virus has been isolated from outbreaks of disease in primate colonies in America.

Molluscum contagiosum: This disease, seen usually in children and young adults, is characterized by pink or pearly white wart-like nodules on the skin. Sections of the lesions show large (20-30 μm) eosinophilic hyaline inclusion bodies which displace the nuclei to the margin. These molluscum bodies are composed of large number of virus particles, embedded in a protein matrix. Humans are the only susceptible hosts. The virus cannot be grown in eggs, tissue cultures or animals.

The incidence of molluscum contagiosum as a sexually transmitted disease in young adults is increasing. When it occurs in the genital area, it may become inflamed and ulcerated and may stimulate HSV infections.

HERPESVIRUS

Introduction

The herpesvirus family contains over a hundred species of enveloped DNA viruses that affect humans and animals. Family Herpesviridae has been divided into three sub families. The virions of this family have the capacity to establish long latent infections from which virus may be reactivated. They are frequently reactivated in AIDS and following immunosuppressive therapy for organ transplantation or in cancer.

Morphology

Herpesviruses are 120-200 nm in diameter. They comprise of four distinct structural elements: envelope, tegument, capsid and core. Envelope is the outermost, it is composed of lipid with numerous small glycoprotein peplomers. Tegument is the electron-dense material present between envelope and capsid. It contains several proteins. Inner to the tegument is icosahedral capsid of 100 nm diameter. It has a total of 162 capsomers. Core, inside the capsid, consists of double-stranded, 124- 235 kb DNA. With the exception of Epstein-Barr virus, members of the family Herpesviridae can be cultivated in cell cultures and produce giant cells and intranuclear inclusion bodies in infected cells. The envelope carries surface spikes, about 8 nm long. Between the envelope and the capsid is an amorphous structure called the tegument, containing several proteins.

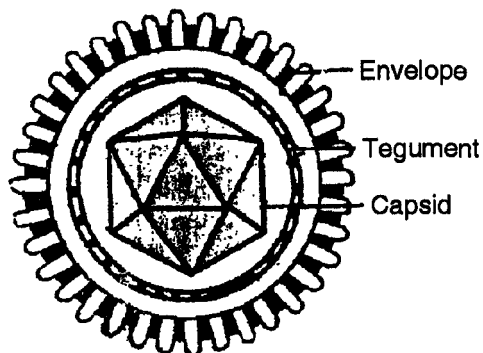

Fig. 11 Herpesvirus

Herpesvirus replicate in the host cell nucleus. They form cow dry type A intranuclear (lipschutz) inclusion bodies. Herpesvirus are susceptible to fat solvents like alcohol, ether, chloroform and bile salt. They are heat labile and have to be stored at -70°C .

The family Herpesviridae is divided into three sub families based on biological physical and genetic properties (Table 12).

TABLE 12
Classification of Family Herpesviridae

Sub family	Common name	Scientific name
I. Alphaherpesviruses		
Characters		
Short replicate cycle (12-18 hrs)	Herpes simplex virus type I	Human herpes virus 1
Variable host range and	Herpes simplex virus type II	Human herpes virus 2
Tendency to cause latent infection in sensory ganglia	Varicella zoster virus	Human herpes virus 3
	Simian herpes B virus	Cercopithecine herpes virus 1

Contd...

...Contd.

Sub family	Common name	Scientific name
II. Betaherpesviruses		
Characters		
Replicate slowly (more than 24 hrs)	Human Cytomegalovirus	Human Herpes virus 5
Narrow host range		Human Herpes virus 6
Grow best in fibroblast with a tendency to produce enlargement of infected cells.		Human Herpes virus 7
Cause latent infection of salivary gland and other organs.		
III. Gamma herpes virus		
Characters		
Narrow host range		
Replicate in lymphoblastoid cells, specific for either B or T lymphocytes	Epstein barr virus. Kaposi's sarcoma associated herpes virus	Human herpes virus 4 Human herpes virus 8
Frequent infection in lymphoid tissues		

HERPES SIMPLEX VIRUS (HSV)

The herpes simplex virus (HSV) occurs naturally only in humans. There are two types of herpes simplex virus: type 1 virus (HSV-1) and type 2 virus (HSV-2). HSV-1 infects primarily the mouth, the eye and the central nervous system (regions of the body above the waist), but it is also responsible for a proportion of cases of genital herpes. HSV-2 infects genital and anal regions.

Pathogenesis

The infections caused by herpes simplex viruses can be divided into primary infection, latent infection, reactivation and recrudescence. Herpes simplex is one of the most common viral infections in humans about 60-90% of adults showing detectable antibody. Primary infection is usually acquired in early childhood (between 2- 5 yrs of age) humans are the only natural hosts and the source of infection are saliva, skin lesion or respiratory secretions. Asymptomatic carriers form the more important source of infection especially in genital infection with type 2 strains. Transmission occurs by close contact and may be venereal in genital herpes. The virus enters through defects in the skin or mucous membranes and multiply locally, with cell to cell spread. The virus enters

cutaneous nerve fibres and is transported intraxonically to the ganglia where it replicates. Herpes virus diseases are more frequent and severe in the HIV infected and other immunodeficient subjects.

Primary infections

HSV is transmitted only by contact. The portal of entry in primary infection is the damaged skin or mucosa and the classic lesion is a vesicle beneath the keratinized squamous epithelial cells. The infection of epithelial cells is cytolytic, the cells lose adhesion, occasionally become multinucleate as a result of virus-induced cell fusion and contain eosinophilic intranuclear inclusions. The vesicle and surrounding tissue contain a dense infiltrate of inflammatory cells, mostly mononuclear. The vesicle drains and the lesion crusts before healing occurs, sometimes with residual scarring, and draining lymph nodes are commonly enlarged during this process. Recurrent lesions are morphologically and histologically similar but are usually less extensive, and lymph node swelling is inapparent.

HSV-1 Causes:

1. Acute gingivostomatitis
2. Herpetic whitlow
3. Keratoconjunctivitis
4. Eczema herpeticum
5. Encephalitis, and
6. Generalized infection

1. Acute gingivostomatitis

It is the most common primary lesion. It leads to acute and painful ulcers, coated with a greyish slough, inside the mouth on the buccal mucosa and on the gums. The lesions may also involve the tonsils, pharynx or nose. Normally, the disease is self-limiting and lesions disappear in 2-3 weeks.

2. Herpetic whitlow

It is an occupational hazard of doctors and nurses, who acquire infection by implantation of virus from saliva and respiratory secretions of patients. The lesion is similar to staphylococcal whitlow, although the exudates is serous rather than purulent. Vesicles may also be produced on the skin of head and neck.

3. Keratoconjunctivitis

Infection of the eye of HSV-1 causes an extremely painful ulceration of cornea and vesiculation of the lids with associated conjunctivitis. In majority of the cases, the primary lesions heal in 2-3 weeks.

4. Eczema herpeticum

It is a super infection of eczematous skin. It is mainly seen in young children. Crops of vesicles appear mainly on already eczematous areas with extensive ulceration. This results in protein loss, dehydration and viraemia. The latter may lead to disseminated disease with fatal consequences.

5. Encephalitis

Both HSV-1 and HSV-2 can also infect central nervous system leading to herpes encephalitis. The main site of infection is temporal lobe where the disease causes necrosis.

6. Generalized infection

Rarely, primary infection with HSV-1 may lead to generalized disseminated infection. Patient develops acute gingivostomatitis, disseminated vesicular skin lesions, hepatitis and involvement of other organs.

HSV-2 causes:

1. Genital herpes
2. Aseptic meningitis, and
3. Neonatal infection

It may rarely cause head and neck infections

1. Genital herpes

HSV-2 causes one of the most prevalent forms of sexually transmitted diseases. It leads to the development of painful vesicles on the genitalia or anal regions with fever, malaise and tender, swollen lymph nodes. In the females, lesions may occur on the perineum, vagina, cervix or vulva. In the males, the lesions may occur on the glans, prepuce or shaft of the penis. HSV-2 proctitis has been reported in homosexual men. Majority (80%) of cases of genital herpes are due to HSV-2 and remaining cases are due to HSV-1. These cases are possibly due to orogenital sexual practices. HSV-2 may also be involved in oral infections. It has also been blamed to cause cervical carcinoma.

2. Aseptic meningitis

It may occur as a complication of HSV-2 genital infection.

3. Neonatal infection

It is acquired by the neonates usually from their mothers during passage through an infected birth canal, but in some cases it may be acquired in the immediate postnatal period from parents and nurses. Prenatally, a very few cases may acquire infection by viraemic transmission across the placenta or by ascending infection from the cervix. This may result in abortions or congenital defects in the child. If a woman has primary genital herpes at the time of delivery, the risk of neonatal herpes is 30-40%. Therefore, caesarean section is indicated in such mothers. Most of the cases of neonatal herpes are due to HSV-2, but those acquired postnatally may be due to HSV-1.

Neonatal herpes may present as:

- disseminated disease, with a case fatality rate of 80% most of the survivors being left with permanent neurologic or ocular sequelae.
- encephalitis, with high mortality, and
- disease localized to mucocutaneous surfaces such as skin, eye and mouth.

Latent infection

During primary infection, the virus travels from the site of infection in the mouth

to the trigeminal and probably other cranial and cervical ganglia. In genital herpes, HSV-2 travels to sacral ganglia. Within the sensory ganglia, viral DNA exists as a free circular episome perhaps about 20 copies per infected cells.

Reactivation and recrudescence

Reactivation of the virus is provoked by various stimuli such as common cold, fever, pneumonia, menstruation, exposure to sunlight stress, etc. In infectious virions migrate along the nerve axon back to the nerve endings, where infection of epithelial cells may result in cluster of vesicles at the mucocutaneous junctions of the lips, in the nose, or eyes or on areas of skin that have experienced a primary infection. Reactivation recurs sporadically, sometimes often, throughout life.

Control

HSV infection can be successfully treated with acyclovir (acycloguanosine). It acts by interfering with viral DNA synthesis by inhibiting virus DNA-dependent DNA polymerase. For the treatment of ophthalmic herpes simplex infection, it may be used in the form of ointment. Oral acyclovir 200 mg 5 times daily for 10 days may be used for the treatment of primary herpes genitalis and orofacial herpes. For the treatment of herpes simplex encephalitis, neonatal herpes and disseminated infection in immunocompromised patients, intravenous acyclovir (10 mg/kg, 3 times daily for 2-3 weeks) may be given.

Varicella-Zoster Virus (VZV)

The virus was first isolated by Weller in human embryonic tissue cultures. VZV causes varicella (chicken pox) in children and zoster (shingles) in adults and immunocompromised patients. Varicella follows primary infection in a non-immune individual while zoster is a reactivation of latent virus when immunity has fallen to ineffective levels. A child can catch varicella from an elderly patient with zoster but the latter occurs only if the elderly or immunocompromised person had suffered from varicella in early part of his life. VZV is similar to the herpes simplex virus in its morphology. The virus was 1st isolated by Weller in human embryonic tissue culture.

Varicella

It is one of the common childhood exanthemata. Portal of entry of the virus is respiratory tract. Incubation period is about 2 weeks. The source of infection is a chicken pox or herpes zoster patient. The portal of entry of virus is the respiratory tract or conjunctiva. After an incubation or period of about 2 weeks (7-23 days) the lesion begins to appear. The earliest manifestation is a maculopopular rash that progresses within a few hours to the vesicular stage. Vesicles characteristically are surrounded by a red rim. The lesions then rupture and crust or may become secondarily infected and pustular before healing.

Pocks are centripetal in distribution i.e. they are more profuse on the trunk followed by neck and proximal areas of limbs. Successive crops of vesicles appear over 2-5 days and as a result at any one time will have lesions at various stages of development on the same area of the skin. The accompanying fever is usually low grade. The incidence

of complications in children is low, the most common problem being secondary infection of lesions and consequent scarring, a problem that can usually be solved by antibiotic treatment.

Infection of adults is generally more severe than in children, the vesicles heal more slowly, secondary bacterial infection and scarring are more common, and the accompanying fever is higher and more prolonged. Some patients of varicella may develop viral pneumonitis, encephalitis, Guillain Barre syndrome and Reye's syndrome. Varicella tends to be more serious in pregnancy, if the patient has not been infected during childhood. VZV can cross the placenta following viraemia in the pregnant woman and infect the foetus. A syndrome of congenital malformations with hypoplasia of limbs, chorioretinitis and scarring of skin associated with maternal varicella in the first trimester may develop. Chicken pox in pregnancy can be dangerous for both mother baby. The disease tends to be more severe in pregnant women, with enhanced risks of complications like pneumonia. The baby may develop two types of complications, depending on the period of gestation when the woman develops chicken pox. If maternal varicella occurs during the first half of pregnancy, the fetal infection may usually be asymptomatic. Some infants may develop the fetal varicella syndrome. While varicella is typically a disease of childhood, herpes zoster is one of old age, being common after the age of fifty years. Herpes zoster usually occurs in persons who had chicken pox several years earlier years after the initial infection, when the immunity has waned, the virus may be reactivated and triggered by some precipitating stimulus, travel along the sensory nerve.

Zoster

Zoster or shingles is an endogenous reactivation of virus which has remained latent in one or more sensory ganglia following primary varicella many years earlier. Virus travels down the sensory nerves to produce painful vesicles in the area of skin (dermatome) innervated from the affected ganglion. Thoracic nerves supplying the chest wall are most often affected. When the ophthalmic nerve of trigeminal ganglion is affected the rash is distributed on the scalp and forehead. In about half of the patients, the eye is affected leading to corneal ulceration, stromal keratitis and anterior uveitis.

The accompanying pain is often very severe for upto a few weeks, and in herpetic neuralgia, which occurs in half of all patients over 60 years of age, may persist for months which may require surgical ablation of the ganglion. Zoster of the seventh cranial ganglion may lead to Bell's palsy and Ramsay Hunt syndrome which is characterized by facial nerve palsy with a rash on the tympanic membrane and the external auditory canal. Zoster may also cause encephalitis. In immunocompromised and cancer patients, disseminated zoster is sometimes seen.

Laboratory diagnosis

1. Direct examination of vesicle fluid by electron microscopy may reveal herpes virus particles.
2. Stained smears from the base of the lesion or sections from biopsy tissue show multinucleated giant cells containing acidophilic intranuclear inclusion bodies.

3. Rapid diagnosis is possible by using monoclonal fluorescent antibody technique.
4. VZV antigens can be detected in vesicle fluid by ELISA.
5. DNA can be extracted from virions in vesicle fluid, amplified by PCR and detected by nucleic acid hybridization.
6. The virus can be isolated from vesicle fluid in human embryonic lung fibroblasts culture. Cytopathic effect is focal with refractile ballooned cells. It develops slowly over a period of 2 or more weeks. However, VZV antigen can be demonstrated in nuclear inclusions by immuno-fluorescence with monoclonal antibody before the end of first week.
7. Recent infection can be diagnosed by ELISA test for varicella- zoster specific IgM antibody in patient serum.

Acyclovir and vidarabine given intravenously are effective in the treatment of severe varicella and zoster (e.g. in the immunocompromised patients).

A live attenuated vaccine from Oka strain of VZV, developed by serial passage in cultured human and guinea-pig fibroblasts is available. It is indicated for active immunization against varicella in healthy subjects from the age of 12 months onwards. A single vaccine dose protects about 90% of recipients for several years. The vaccine induces fever and a few skin papules, occasionally in normal children but much more frequently in immunocompromised children. For instance, a significant minority of children with leukaemia, or on steroid therapy may develop mild varicella following vaccination. The vaccine may also establish latent infection in dorsal ganglia and may lead to zoster in the years ahead, but such reactivation is less frequent than that following natural varicella infection.

Epstein-Barr Virus (EBV)

The EBV virus is ubiquitous in all human population. EBV has been named after the virologists (Epstein and Barr) who first observed it under electron microscope in cultures of lymphoblasts from burkitt's lymphoma. EBV replicates in epithelial cells of nasopharynx and salivary glands, especially the parotid, lysing them and releasing infectious virions into saliva. B lymphocytes appear to become infected when they infiltrate infected nasopharyngeal mucosa. Inside B cells, EBV normally fails to replicate but establishes life long latency. In these cells, EBV genome persists as multiple full-length copies in the form of circular episomes. EBV has oncogenic properties and a proportion of infected B lymphocytes undergo transformations and transform cells *in vitro* too. Activated B lymphocytes secrete immunoglobulins especially IgM.

EBV possess envelope glycoprotein gp 350/220, which mediates attachment of the virus to CD21 receptors present on the susceptible cells. Most shedding of virus takes place in the oral cavity, therefore, transmission of virus requires salivary contact, either through kissing or contaminated eating utensils. This accounts for infection mononucleosis being called the kissing disease. The source of infection is tissues the saliva of infected person who shed the virus in oropharyngeal secretion for months following primary infection and intermittently thereafter intimate oral contact as in kissing, appears to be

the predominant mode of transmission. Most infections are symptomless, especially when acquired during childhood. However, in adolescents it may cause infectious mononucleosis or glandular fever, infections in immunocompromised hosts and when EBV exerts its oncogenic potential, it may cause Burkitt's lymphoma, B cell lymphoma and nasopharyngeal carcinoma.

Infectious Mononucleosis (Glandular fever)

It is a primary EBV infection seen mainly in the 15-25 years age group. EBV is commonly transmitted by infected saliva and initiates infection in the oropharynx. Viral replication occurs in epithelial cells of the pharynx and salivary glands. Many people shed low levels of virus for weeks to months after infection. Following replication in epithelial cells, the virus infects B lymphoid cells, where it persists in a latent state. In normal individuals, most virus-infected cells are eliminated but small numbers of infected lymphocytes persist for the life-time of the host.

EBV-infected B cells synthesize immunoglobulins. Autoantibodies are typical of the disease. Heterophile antibody that reacts with antigens on sheep erythrocytes is the classic autoantibody. In addition, many autoantibodies react with cytoskeletal components. EBV infection causes activation of many B cells that are not infected, and these may be the source of autoantibodies.

After an incubation period of 4-7 weeks, patient presents with sore throat due to exudative tonsillitis, generalized lymphadenopathy, fever, malaise, headache, sweating, fatigue and gastrointestinal discomfort. In some cases spleen and liver are often enlarged. A faint transient morbilliform rash may be seen. A maculopopular rash may appear, especially following treatment with ampicillin due to immune complexes with antibody to ampicillin. The disease usually lasts for 2-3 weeks. However, some patients develop complications such as Guillain Barre syndrome, Bell's palsy, meningoencephalitis, transverse myelitis, haemolytic, anaemia, thrombocytopenia, carditis, nephritis, pneumonia and splenic rupture.

Infections in Immunocompromised Host

- EBV causes X-linked lymphoproliferative syndrome in male members of certain families with an X-linked recessive immunodeficiency with a reduced ability to synthesize interferon. About half of the boys die, within a month, from sepsis or haemorrhages and remainder develop and die from B cell lymphoproliferation with associated hypogammaglobulinaemia and later lymphoma.
- EBV may cause progressive lymphoproliferative disease in transplant recipients, immunodeficient children and AIDS patients.

Cytomegalovirus (CMV)

In vivo, CMV replicates in epithelial cells in salivary glands, kidneys and respiratory epithelium. *In vitro*, they can be isolated on human fibroblast cells. An individual infected with CMV carries the virus for life and may shed it intermittently in saliva, urine, semen, cervical secretions and breast milk. The virus is found in 0.3-2.4% of population that have

been sampled throughout the world. Infection is transmitted by close contact between individuals and blood transfusion. It may be acquired at any time, i.e. prenatal, perinatal and postnatal. CMV are the largest viruses in the herpesvirus family being 150-200 nm in size. Cytomegaloviruses have been identified in human beings, monkeys, guinea pigs and some other. CMV spreads slowly and probably requires close contact for transmission. It may spread through salivary or other secretions or by sexual contact. A special method of transmission is by blood transfusion or organ transplants. They are highly infectious in early infancy.

Prenatal (intrauterine) infection

CMV is the most common agent to cause intrauterine infection and prenatal damage to foetus leading to congenital abnormalities. Approximately 1% of all babies become infected in utero. Maternal viraemia following primary CMV infection or a reactivation during pregnancy may result in foetal infection. Majority (95%) of these are without obvious symptoms at the time of birth and 5% symptomatic infants have cytomegalic inclusion body disease. These infants show signs of growth retardation, hepatosplenomegaly, jaundice, thrombocytopenia, microcephaly, encephalitis and chorioretinitis. Of the remaining 95% about 15% develop deafness and mental retardation.

Post natal infection

This is acquired from infected maternal genital secretions or from breast feeding.

Post natal infection

This may be acquired by kissing (from saliva), sexual intercourse or artificial insemination (from semen), blood transfusion and organ transplantation.

Infections acquired it may cause hepatitis in young children. In adults and older children, it may cause a syndrome resembling EBV infectious mononucleosis, but with a negative Paul-Bunnell test and no pharyngitis or lymphadenopathy. CMV may cause widely disseminated infection in immunocompromised individuals such as graft recipients and AIDS patients leading to interstitial pneumonia, chorioretinitis, hepatitis, arthritis, chronic gastrointestinal infection, encephalitis, Guillain-Barre syndrome and transverse myelitis.

Treatment

For the treatment of severe CMV infections such as pneumonia, chorioretinitis and colitis in AIDS patients or in other immunocompromised patients, ganciclovir is the drug of choice.

To produce zoster lesions on the area of the skin or mucosa supplied by it. This reactivation is associated with inflammation of the nerve which accounts for neuritic pain that often precedes the skin lesions. The rash is typically unilateral and confined to the area supplied by a single sensory ganglion. The rash heals about in two weeks. Pain and parasthesia at the affected area may persist for weeks or months. Other complications are lower motor neuron paralysis which sometimes ensues, meningoencephalitis and generalized zoster where the lesions are scattered widely, perhaps due to haematogenous dissemination of the virus.

Herpes zoster represents a mode of evolutionary adaptation by V-2 virus which is obligate human parasite.

Human Herpesvirus 6

Human herpesvirus 6 (HHV-6) with characteristic herpes group features, was discovered in human lymphocytes in 1986. It infects dividing CD4 + T lymphocytes. Infected T cells show ballooning with nuclear and/or cytoplasmic inclusions. Macrophages are also infected. These comprise an important reservoir of HHV-6. It can be isolated from saliva, thus suggesting that salivary glands may act as major reservoir and the saliva as main route of transmission. It can be cultured on transformed B lymphocytes, NK cells, glial cells, fibroblasts and epithelial cells.

Most HHV-6 infections appear to be symptomless. They may, however, causes:

1. **Exanthema subitum or Roseola infantum:** This is a mild facial rash occurring commonly between 6 months and 3 years of age with sudden onset of fever.

2. **Mononucleosis with cervical lymphadenopathy:** This may occur in a few adults developing primary infection.

Laboratory diagnosis

HHV-6 can be isolated from peripheral blood mononuclear cells in early febrile stage of the illness by co-cultivation with cord blood lymphocytes. Virus antigen can be detected in the infected cells by immunofluorescence using monoclonal antibodies. Virus genome can be amplified by PCR. Both virus antigen and antibodies can be detected, in patient serum by ELISA.

Human Herpesvirus 7

Human herpesvirus 7 (HHV-7) was discovered in 1990. Like HHV-6, it may also cause roseola infantum. It is proposed that a new genus Roseolovirus may be created for HHV-6 and HHV-7, which belong to the sub family betaherpesvirinae. Both HHV-6 and HHV-7 infect T lymphocytes using the same CD4 receptors on these cells.

Human Herpesvirus 8

Human herpesvirus 8 (HHV-8) was identified in 1994. It has been blamed to cause Kaposi's sarcoma, which is a commonest tumour in HIV-infected individuals. DNA amplification by PCR is the method of detection of HHV-8.

Cercopithecine Herpes Virus 1

Cercopithecine Herpes Virus 1 or simian herpes B virus or herpes virus simiae is similar to herpes simplex virus. It commonly infects old World (Asiatic) macaque monkeys causing a mild vesicular eruption on the tongue and buccal mucosa similar to primary herpetic stomatitis in humans. Human infection with herpes B virus may be acquired from a bite or from handling infected animals. The typical lesions produced are vesicles on the buccal mucosa, which ulcerate shedding the virus and infecting contacts. Infection has also been transmitted in the laboratory from infected monkey kidney cell cultures.

After 5-20 days of exposure patient develops local inflammation at the site of entry, usually on the skin, accompanied by itching, numbness and vesicular lesions. It may be followed by fatal ascending myelitis. Diagnosis can be made by:

- electron microscopy of vesicle fluid.
- isolation of the virus from blood, vesicle fluid, conjunctival swab and CSF, and
- DNA amplification by PCR.

Adeno Virus

Members of family Adenoviridae are nonenveloped, icosahedral viruses containing linear double-stranded DNA that replicates in the nucleus of the infected cell. The family comprises of two distinct genera: *Mastadenovirus* and *Aviadenovirus*. They possess mammalian and avian adenoviruses respectively. There are 47 serotypes of human adenoviruses, which have been assigned to 6 (A-F) sub-genera. Adenovirus infections are common world wide mostly in children. Adenoviruses cause infection of the respiratory tract and eyes and less often of the intestine and urinary tract.

Human adenovirus are classified into six groups (called subgroups as sub genera) based on properties such as hemagglutination fibre length, DNA fragment analysis and oncogenic potential.

TABLE 13
Classification of Human Adenoviruses

Sub genus	Serotype	Total
A	12, 18, 21	3
B	3,7,11,14,16,21,34,35	8
C	1,2,5,6	4
D	8-10,13,15,17,19,20,22-30,32,33,36-39,42-47	29
E	4	1
F	40,41	2
Total		47

Morphology

Adenoviruses are icosahedral virions containing double-stranded DNA. They measure 80-110 nm in diameter. Each capsid is composed of 252 capsomers; 240 hexons make up the 20 triangular faces of icosahedron and 12 pentons form the vertices. From each penton projects an apical fibre, 9-31 nm in length that serves to bind specifically to receptor sites on the host cell. Thus the virion has the appearance of a space vehicle.

Resistance

Adenoviruses remain viable for about a week at 37°C. They are readily inactivated at 50°C. They resist ether and bile salts.

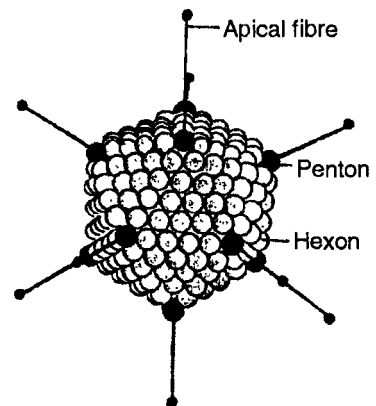

Fig 12 : Morphology of adenovirus

Cultivation

Human adenoviruses can be grown on monolayers of HeLa, HEp-2, KB and human embryo kidney cells. Cytopathic effects may take 1-4 weeks and consist of cell rounding and aggregation in grape-like clusters. Infected cells swell and become rounded and show characteristic basophilic intranuclear inclusions in stained preparation.

Pathogenesis

Adenoviruses may infect via the conjunctiva or the nasal mucosa. Faecal-oral spread, particularly among children can also occur. They multiply initially in the conjunctiva, pharynx or small intestine and spread to preauricular, cervical and mesenteric lymph nodes. Most of the enteric and some of the respiratory infections are sub clinical. In children, asymptomatic infection of tonsils and adenoids, leading to respiratory carriage, and Peyer's patches, leading to gut carriage, may persist for weeks or months.

Most of the adenovirus infections are caused by adenoviruses serotypes 1-8. Serotypes 40 and 41 may cause infantile gastroenteritis, 8, 19 and 37 lead to eye infections and serotypes 19 and 37 may also cause genital infections. Five serotypes (43-47, subgenus D) have been recovered from the faeces of AIDS patients. However, their role in these patients is not known. Adenovirus infections lead to lasting immunity to reinfection with the same serotype.

Clinical syndromes

Incubation period is 5-8 days after which it may lead to:

Adenovirus cause infections of the respiratory tract, eye bladder and intestine more than one type of virus may produce the same clinical syndrome and one type of virus may cause clinically different diseases. The following syndromes have been recognized:

1. Respiratory infections

- Pharyngitis: Serotypes 1-7 are usually responsible for pharyngitis particularly in young children.
- Pneumonia: Pneumonia in infants and young children may be caused by any of the common serotypes particularly serotypes 1, 2, 3 and 7. In military recruits, pneumonia may be caused by serotypes 4 and 7. In infants and young children type 7 may lead to more serious and even fatal pneumonia.
- Acute respiratory disease: This syndrome is characterized by fever, chills, pharyngitis, cervical lymphadenitis, non productive cough and malaise. This occurs usually in outbreaks in military recruits when they assemble in camps. It is generally caused by adenoviruses serotypes 3, 4, 7, 14 and 21.

2. Ocular infections

- Pharyngoconjunctival fever: This syndrome of febrile pharyngitis and conjunctivitis occurs in outbreaks in children. It is usually caused by adenoviruses 3, 4, 7 and 14. This is seen in civilian population.
- Epidemic keratoconjunctivitis: It is a severe and highly contagious infection involving all age groups. It often occurs in epidemic form and is characterized

by follicular conjunctivitis and progresses to involve the cornea. It was first associated with adenovirus type 8, but other serotypes (e.g, 3,4,7, 19 and 37) have also been incriminated in this syndrome.

3. Genitourinary infections

- Cervicitis and urethritis: These venereal infections are caused by serotype 37.
- Acute haemorrhagic cystitis: It is mainly seen in infants and young children and is caused by serotypes 11 and 21.

4. Enteric infections

- Infantile gastroenteritis: Serotypes 40 and 41 may cause infantile gastroenteritis in up to 10% of the cases.

Some human adenoviruses produce carcinomas if injected into new born hamsters, mice or rats. Infection of cultured hamster or rat cells, *in vitro*, also results in transformation. However, there is no evidence that this can occur in man too.

Epidemiology: Adenovirus are endemic and types 1-7 spread readily between individuals presumably by droplets. Faecal oral transmission can also occur and probably does in areas with poverty poor hygiene and over crowding. Type 40 & 41 which are widespread are causes of diarrhoea even in highly developed countries, also spread via droplets.

Adeno associated viruses

EM of adenovirus preparation have shown small icosahedral viral particles 20-25 nm in diameter. They are unable to replicate independently as they lack enough DNA or they contain insufficient single stranded DNA. They can multiply only in cells simultaneously infected with adenoviruses and are called adeno associated viruses (AAV) or adenosatellite viruses. They have been classified as the genus dependovirus (referring to their dependence on adenoviruses) under the family parvoviridae. Type 1, 2 and 3 of human origin and cause natural infection while type 4 is of simian origin. Their pathogenic role is uncertain.

Control

There are no anti viral drugs available that are unequivocally effective for the treatment of adenoviral infections. Ribavirin, ganciclovir, vidarabine and cidofovir have all been shown to have antiviral activity *in vitro* and there are anecdotal report of their therapeutic use in immuno compromised patients with variable success.

POLYOMAVIRUS

Polyomavirus The name is derived from 'poly' (many) and oma (tumour). The viruses are species specific, recognized members of this group include the mouse polyomavirus, SV40 of monkeys and two viruses of man JC virus and BKV. Both named after the initials of the people from whom they were first isolated. SV 40 stands for simian virus 40. Its double stranded DNA has been exploited the most as vectors for gene transfer into animal cells.

During 1950's the widespread use of monkey kidney cells for isolating polioviruses and preparing vaccine brought to light many viruses that caused in apparent infections, not until the cells were explanted into culture vessels did cytopathic effects become obvious. These agents were termed 'Simian viruses' one of them that induced a vacuolated or foamy appearance in the cytoplasm was termed SV 40.

Polyomaviruses: SV40

Some viruses of the polyomavirus family induce tumors in animals. One of these DNA tumor viruses was first isolated from monkeys, and it was thus called simian virus 40 or SV40. Virus SV 40 was one of the first genetic elements to be studied by genetic engineering techniques and has been extensively used as a vector for moving genes into eukaryotic cells.

The SV 40 virion is a non enveloped particle 45 nm in diameter with an icosahedral head containing 72 protein subunits. Unlike RNA viruses, there are no enzymes in the virion. The genome of SV 40 consists of one molecule of double-stranded DNA of 5243 bp. The DNA is circular and exist in a supercoiled configuration within the virion. The complete base sequences of SV40 has been determined.

SV 40 nucleic acid is replicated in the nucleus, while the proteins are synthesized in the cytoplasm. Final assembly of the virion occurs in the nucleus. The replication of these viruses can be divided into two distinct stages, early and late. During the early stage, the early region of the viral DNA is transcribed. A single RNA molecule, the primary transcript, is made by cellular RNA polymerase, but it is processed into two mRNAs, a large one and a small one. Introns are present in the SV40 genome, so they are excised out of the primary RNA transcript. In the cytoplasm, the mRNAs are capped and translated to yield two proteins. One of these proteins, the T-antigen, binds to the site on the parental DNA that is the origin of replication, this initiates viral genome synthesis.

The genome of SV40 is too small to encode its own DNA polymerases, so host DNA polymerases are used. Replication occurs in a bidirectional fashion from a single origin of replication. The process involves the same events that have already been described for host cell DNA replication.

Late SV40 mRNA molecules are synthesized using the strand complementary to that used for early mRNA synthesis. Transcription begins at a promoter near the origin of replication. This late RNA is then processed by splicing, capping, and polyadenylation to yield mRNA corresponding to the three coat proteins, VP1, VP2, and VP3. SV 40 coat protein mRNAs are then transported to the cytoplasm and translated into the viral coat proteins. The latter are then transported back into the nucleus where virion assembly takes place. Release of new SV40 virions occurs by cell lysis. Within the permissive monkey cells two genes are expressed immediately after infection. These early genes represent two tumour causing antigens, namely small tumour (t) and a large tumour (T) proteins.

Some polyomaviruses cause cancer. When a virus of the polyomavirus group infects a host cell, one of two modes of replication can occur, depending on the type of host cell. In some types of host cells, known as permissive cells, virus infection results in the usual formation of new virions and the lysis of the host cell. In other types of host cells,

known as non permissive, efficient multiplication does not occur. Instead, the virus DNA becomes integrated into host DNA, analogous to a prophage in the process genetically altering the cells. Such cells can show loss of growth inhibition and become tumor cells, a process called transformation. As in certain tumorigenic retroviruses, expression of specific polyomavirus genes leads cells to the transformed state.

Most double-stranded DNA animal viruses, such as SV40, replicate in the nucleus. SV40 has a tiny genome and employs the strategy of overlapping genes to boost its genetic-coding potential. Some of these viruses cause cancer.

HEPATITIS VIRUSES

The term 'viral hepatitis' refers to primary infection of the liver by any one of a heterogenous group of 'hepatitis viruses' which currently consist of types A, B, C, D, E and G. Type F had been proposed for a putative virus believed to cause transfusion associated hepatitis.

Hepatitis virus are taxonomically unrelated except type B. Which is a DNA virus all others are RNA virus. The differentiation is based on their serological and molecular markers. Hepatitis F proved to be a mutant of type B virus and not a separate entity. Therefore, it has been deleted from the list of hepatitis viruses. Non viral causes of hepatitis include *Leptospira*, *Treponema pallidum*, *Mycobacterium tuberculosis*, *Toxoplasma gondii* and *Entamoeba histolytica*. In the United States, hepatitis B, A and C account for about 40%, 30% and 20% respectively. In about 2% cases, hepatitis D occurs in concert with hepatitis B. Only a handful of hepatitis E cases are reported every year, none originating in the United States. All are in travellers coming back from countries where the virus is endemic.

All types of viral hepatitis produce clinically similar illnesses. These range from asymptomatic and inapparent to fulminant and fatal acute infections common to all types, on one hand, and from sub clinical persistent infections to rapidly progressive liver disease with cirrhosis and even hepatocellular carcinoma, common to the blood-borne types (HBV, HCV & HDV), on the other. Without specific virological tests, it is not possible to determine which hepatitis virus is responsible for a case of hepatitis. On the basis of epidemiological and clinical criteria, two types of viral hepatitis are known one type occurred sporadically or as epidemics, affecting mainly children and young adults and transmitted by fecal-oral route. This is called infective or infectious hepatitis called type A hepatitis. Second type of viral hepatitis, transmitted mainly by inoculation was originally observed in persons receiving serum inoculation or blood transfusion called as serum jaundice, serum hepatitis transfusion hepatitis called as type B hepatitis. Soon a type C virus was identified as causing many transfusion associated hepatitis cases. A defective virus which depends on the helper functions of type B virus was called delta or type D hepatitis viruses another type of hepatitis transmitted by the facial oral route prevalent only in developing nations is due to E virus. The sixth member of this group hepatitis G virus can also cause hepatitis but its role is not yet been understood.

Both HAV & HEV are shed in high titres in the faeces of infected individuals. In each case, the virus present in faeces is replicated primarily in the liver & reaches the intestinal tract following secretions from the hepatocytes into biliary canaliculi and

TABLE 14
Hepatitis viruses

Feature	Hepatitis A virus	Hepatitis B virus	Hepatitis C virus	Hepatitis D virus	Hepatitis E virus	Hepatitis G virus
Year of identification	1973	1965	1989	1977	1980	1995
Family	Picornaviridae	Hepadnaviridae	Flaviviridae	Unclassified	Caliciviridae	Flaviviridae
Genus	Hepatovirus	Orthohepadnavirus	Hepacivirus	Deltavirus	Unnamed	Hepacivirus
Genome	ssRNA	dsDNA	ssRNA	ssRNA	ssRNA	ssRNA
Genome size	7.5 kb	3.2 kb	9.4 kb	1.7 kb	7.6 kb	9.4 kb
Virion	27nm, icosahedral	42 nm, spherical	30-60 nm, spherical	36-38 nm, spherical	27-38 nm, icosahedral	?
Envelope	No	Yes (HBsAg)	Yes	Yes (HBsAg)	No	?
Stability	Heat & acid-stable	Acid-stable	Ether & acid-sensitive	Acid-sensitive	Heat-stable	?
Transmission	Faecal-oral	Parental, sexual	Parental, sexual	Parental, sexual	Faecal-oral	Parental, sexual
Vertical transmission						
- Intrauterine	No	Yes	Possible but rare	Possible but rare	Yes	?
- Perinatal	No	Yes	Yes	Yes	Yes	Yes
- Early post natal infection	Possible but rare	Possible but rare	Possible	?	?	?
Incubation period	2-6 weeks	6 weeks-6 months	6-8 weeks	6 weeks-6 months	2-8 weeks	?
Onset	Acute	Insidious or acute	Insidious	Insidious or acute	Acute	?
Age preference	Children, young adults	Young adults, babies, toddlers	Any age but more common in adults	Any age	Young to middle age adults	?
Antigens	HAV	HBsAg, HBcAg, HBeAg	HCV	HBsAg, HDAg	HEVAg	?
Antibodies	Anti-HAV	Anti-Hbs, Anti-HBc, Anti-HBe	Anti-HCV	Anti-HBs, Anti-HD	Anti-HEv	?
Chronic carrier state	No	5-10%	50%	>50%	No	?
Chronic hepatitis, cirrhosis	No	1-5%	20%	>50%	No	?
Hepatocellular carcinoma	No	Yes	Yes	No	No	?

? data not yet available

passage through the bile ducts. The absence of a lipid envelope is an important factor in this process, as it renders both HAV and HEV stable when suspended in bile. In contrast, the other human hepatitis viruses possess an outer envelope and are likely to be rapidly inactivated in bile. The newly replicated HAV and HEV particles have a direct route to the outside environment that is denied to other hepatitis viruses.

Hepatitis A virus (HAV)

It is a subacute disease of global distribution affecting mainly children and young adults. HAV is a 27 nm non enveloped RNA virus belonging to the picornavirus family. Only one serotypes of the virus is known. Natural infection with HAV is seen only in humans. Type A hepatitis occurs sporadically or as outbreaks which may be caused by contaminated food, water or milk. In India, type A hepatitis is the most common cause of acute hepatitis in children but is much less frequent in adults.

Hepatitis A virus (HAV) was previously classified as enterovirus type 72. HAV is a nonenveloped 27 nm icosahedral virus containing linear, single-stranded RNA, 7.5 kb in length and of positive polarity (Table). It has only one serotype. HAV is one of the most stable viruses infecting humans. It can withstand heating at 60°C for one hour and treatment with 20% ether, acid (pH 1.0 for 2 hours) and many disinfectants. Inactivation of viral activity can be achieved by boiling for 1 minute, by contact with formaldehyde and chlorine, or by ultraviolet irradiation. It can be transmitted to chimpanzes and several species of marmoset monkeys and can be grown in cell cultures of primate and human cells. HAV is the only one of the human hepatitis viruses that can be cultivated *in vitro*.

Pathogenesis

HAV is shed early in the stools of infected individuals, 1-2 weeks prior to the onset of symptoms, and persists for the first several days after the transaminase levels peak. There is very little virus in the serum and hardly any at all in other body fluids which explains the epidemiology of the disease as faecal-oral enteric infection. Transfusion-associated hepatitis A is exceedingly rare. It probably multiplies first in the intestinal epithelial cells and then spreads to the liver via the blood. Viral antigens can be seen in the cytoplasm of hepatocytes.

HAV occurs throughout the world and is endemic in countries with substandard hygiene and sanitation, so the vast majority of native population have detectable anti-HAV by the age of 10 years. In developed countries, acute hepatitis A tends to be a sporadic overt febrile illness.

Hepatitis A is an acute self-limiting disease with an incubation period of 2-6 weeks. The onset is abrupt with fever, malaise, anorexia, nausea and lethargy which comprise the prodromal (preicteric) stage. Hepatomegaly, due to cell necrosis, causes blockage of the biliary excretions resulting in jaundice. It may also produce pain in the right upper abdominal quadrant. The fulminant form of hepatitis A and liver failure can occur in less than 0.5% cases. Complete recovery occurs in 8-12 weeks. Hepatitis A has no adverse effect on the outcome of pregnancy. Transmission during birth by exposure to

maternal faeces or by breast-feeding has been reported. Type A hepatitis occurs sporadically, which may be caused by contaminated food, water or milk.

The severity of the disease varies with age. Only 5% of the children under 3 years of age develop jaundice, while more than 50% of adults develop it. Fatality rate is also more in adults. In contrast to hepatitis B, hepatitis A infection does not produce extrahepatic manifestations, no carrier state and is not associated with cirrhosis or hepatocellular carcinoma. In India, most individuals are infected early in life, up to the age of 15 and the disease is mild. However, over the next several decades, as standards of hygiene including water supply improve, HAV will become a disease of adults in India, as it is in the US.

Prophylaxis

1. Proper collection, treatment and disposal of sewage.
2. Bathing and cultivation of shellfish for human consumption should not be allowed near sewerage outlets.
3. Passive immunization with normal human immunoglobulin (NIG) gives protection to sero-negative individuals for a period of 4-6 months. It is recommended for the personnel travelling to highly endemic areas of the tropics and for the control of outbreaks in institutions such as homes for the mentally handicapped. Hepatitis A vaccine consisting of formalin inactivated preparation of virions grown in human fibroblasts or monkey kidney cell lines, adsorbed to alum as an adjuvant can be used for active immunization. Two doses injected one month apart with or without a booster after 6 months elicit a good immune response in 99% of vaccines lasting for some years. Because of the low yield of virus from cultured cells the vaccine is costly. It may be given to high risk individuals like long-term visitors to countries in which HAV is endemic, sewage workers, sexually active homosexual men and intravenous drug users.

Hepatitis B Virus (HBV)

Type B hepatitis is the most widespread and most important type of viral hepatitis. Total 1/3 of the world populations is estimated to be infected by HB virus. A quarter of these develop serious liver disease, including chronic hepatitis, cirrhosis and primary hepatic cancer.

The family Hepadnaviridae contains 5 hepatotropic viruses specific for man (HBV), wood chuck (WHV), ground squirrel (GSHV), duck (DHBV) and heron (HHBV). All these viruses are highly species specific, for example, the heron HBV does not infect ducks, and the wood chuck virus does not infect ground squirrels. These viruses contain double-stranded DNA genomes and induce persistent infections in their natural hosts. HBV, WHV and GSHV have been associated with the development of hepatocellular carcinoma. Only HBV causes human infection, therefore, only this virus will be discussed further.

Morphology

HBV or Dane particle is a complex 42 nm double shelled particle. The outer surface or envelope contains hepatitis B surface antigen (HBsAg). It is made up of lipid, protein

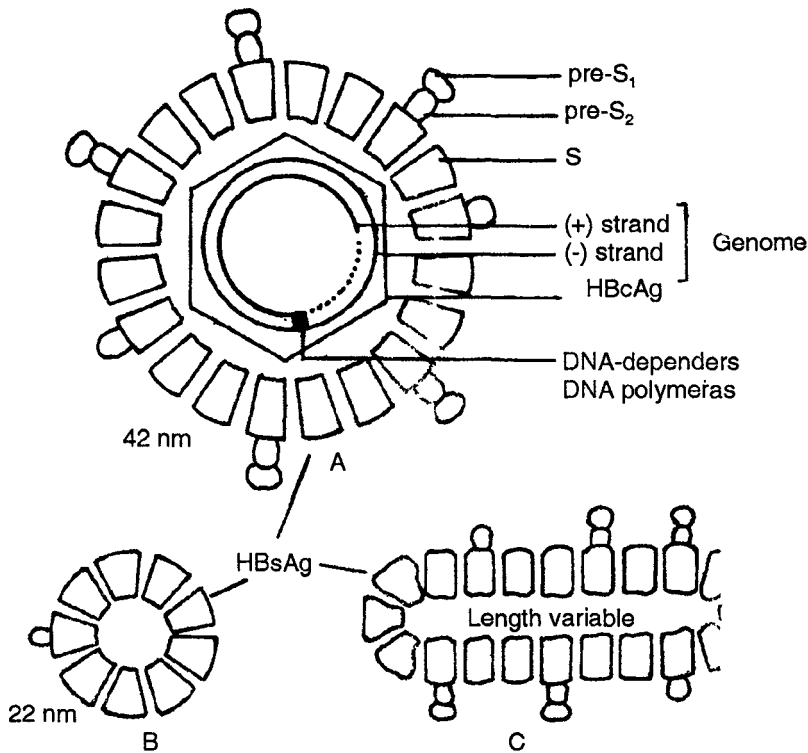

Fig. 13 : Schematic diagram of hepatitis B virus particles A, Dane particle, B spherical particle, and C tubular particle

and carbohydrate. It encloses an inner icosahedral 27 nm nucleocapsid (core). It contains hepatitis B core antigen (HBcAg). Inside the core is the genome of HBV and a DNA-dependent DNA polymerase. The HBV genome consists of a 3.2 kilobase pair molecule of circular dsDNA of most unusual structure. The plus strand is incomplete leaving 15-50% of the molecule single-stranded. The minus strand is complete and contains four overlapping open reading frames (genes) coding for multiple proteins.

1. The P gene (or POL), which comprises 80% of the genome and overlaps all the other genes, encodes DNA polymerase with three distinct enzymatic functions (DNA polymerase, reverse transcriptase, and RNase H)

2. S gene encodes the envelope protein, which occurs in three forms a large protein, translated from pre-S₁, pre-S₂, plus S regions of the genome and occurs in the envelope of infectious virions; a middle-sized protein comprises the product of pre-S₂ plus S; and finally the most abundant product is the S protein, the basic constituent of non-infectious HBsAg particles, the product of S gene only.

3. The C gene has two initiation sites that divide it into a pre-C and a C region, producing two distinct proteins, HBeAg and HBcAg respectively.

4. Gene X, spanning the cohesive ends of the genome encodes for HBxAg, which can transactivate the transcription of cellular and viral genes, its clinical relevance is not known.

From the core protein is derived hepatitis Be antigen (HBeAg). It is associated with the virion and is also found free in the plasma, especially when there is active viral replication.

Along with the mature virions, two sub virion morphologically forms are formed in large excess. (1) Spherical particles with a diameter of 22 nm and (2) Elongated tubules of similar diameter. Both these pleomorphic structures are composed of HBsAg, are devoid of HBcAg and nucleic acid. They are not infectious and consists solely of surplus virion envelope. They normally occur in large (100 to 1,000 fold excess over the mature 42 nm virions).

HBsAg carries a group-specific antigen 'a' and two type -specific antigens, 'd' or 'y' and 'w' or 'r'. Thus there are four antigenic types of HBsAG - adw, adr, ayw and ayr. Type ayw is predominant in Africa, Russia and India, particularly in parenteral drug users. Type adw is predominant in Europe and USA particularly in homosexual men and type adr is predominant in Asia. The w antigen has additional four variants and additional antigens such as 'q', 'x' and 'g' have been identified, but they have not been characterized. HBV is present in the blood mainly in the form of HBsAg and to smaller extent as Dane particles.

HBV has not been cultivated in the laboratory. Experiments on chimpanzee inoculation reveal that the virus gets inactivated by heating at 60°C for 10 minutes and by treatment with hypochlorite (10,000 ppm available chlorine) and 2% glutaraldehyde in 10 minutes.

Pathogenesis

There are three important modes of transmission of HBV infection: parenteral, perinatal and sexual.

1. Parenteral transmission: HBV is present in the blood and in body fluids such as semen, vaginal secretions, menstrual discharge, saliva, colostrums and breast milk. The concentration of HBV in blood and body fluids is much greater than HIV. Less than 1 µl of blood contaminating a syringe or needle, can readily transmit hepatitis B from one individual to another. Transmission of infection may result from accidental inoculation of minute amounts of blood or fluid containing HBV during medical, surgical or dental procedures. Needlestick injuries, use of contaminated needles and syringes, intravenous and percutaneous drug abuse, ear and nose piercing, tattooing, acupuncture, sharing of shaving razor and kissing can transmit HBV infection. HBsAg has been demonstrated in several species of mosquitoes and bed bugs, but transmission of infection by arthropods has not been authenticated. Professionals occupationally at risk include dentists, surgeons, pathologists, mortuary attendants and technicians working in serology, haematology, blood bank biochemistry, microbiology and haemodialysis units.

Epidemiology: Hepatitis B occurs throughout the world. There is no seasonal

distribution. The infection is usually sporadic, though occasional outbreaks have occurred in hospitals, orphanages and institutions for the mentally handicapped.

The prevalence of hepatitis carriers varies widely in different countries, in relation to their living standards. The overpopulated under developed regions have high endemicity (carrier rate more than 8% as in equatorial Africa, South East Asia, China, parts of South America); low endemicity in the developed countries (carrier rate less than 2% in Western Europe, North America, Australia) and intermediate endemicity in other areas (carrier rate 2 to 7%, as in Eastern Europe, the middle east south Asia and parts of South America). India falls in the intermediate group, with higher carrier rates in the southern part of the country and lower rates in the northern part.

The rich and the poor countries also differ in the age and modes of infection. In the former, infection occurs mostly in adolescents and young adults through contaminated syringes and needles, typically among drug addicts, and through sex, particularly by homosexual intercourse. In the poor countries, infection occurs usually at younger ages, either perinatally from mother to baby, or horizontally among children.

Natural infection occurs only in humans. There is no animal reservoir. The virus is maintained in the large pool of carrier whose blood contains circulating virus for long periods, in some even lifelong. A carrier is a person with detectable HBsAg in blood for more than 6 months. Following infection, about 5-10% of adults, 30% of children and 90% of neonates become carriers. The carrier state is more common among males. There are over 350 million carriers now worldwide. Of them, about 45 million are in India, which has the second largest carrier pool, next only to China.

Transfusion of carrier blood, once the most widely known mode of infection has largely been eliminated wherever donor screening is strictly enforced. Therapeutic and prophylactic preparations from pooled human blood and serum have led to hepatitis, but this risk is now minimal, with screening of donors and production techniques ensuring virus inactivation. However HBsAg screening is not a totally fail safe method as infection has occurred even with HBsAg negative, anti-HBc positive blood, which may have had undetectable amounts of virus.

Many other therapeutic, diagnostic, prophylactic and even non medical procedures are now the main modes of infection. HBV is very highly infectious, far more than HIV. Any object or procedure that can convey minute traces of infected blood or other material, as little as 0.00001 ml, can be infectious. These include shared syringes, needles and other sharp items or endoscopes, personal articles such as razors, nail clippers and combs, and practices such as acupuncture, tattooing, ritual circumcision, ear or nose piercing, and field camps for surgery or disease detection by blood testing where separate sterile articles may not be available. Professionals using sharp articles like barbers, dentists and doctors may unwittingly transmit the virus if great care is not taken.

Infection by direct contact with open skin lesions such as pyoderma, eczema, cuts and scratches is very common among young children in developing countries as also through household transmission where opportunities exist for contact with blood or saliva among members.

HBV has been shown to survive in mosquitoes and bed bugs for about 2 weeks after blood meal, but no virus multiplication occurs. They do not appear to transmit the infection.

Congenital or vertical transmission is quite common from carrier mothers. The risk to babies is high if the mother is HBeAg positive (60-90%) and low if negative (5-15%). True congenital infection (in utero, transplacental) is rare. Infection is usually acquired during birth by contact of maternal blood with the skin and mucosa of the fetus, or in the immediate postnatal period. Infection by ingestion has been reported, but its efficiency is very low. However it is safer if carrier mothers do not breast feed when proper nutrition of their babies can be otherwise ensured. HBV infected neonates generally do not suffer from any clinical illness, but remain carriers for life and some of them may develop hepatocellular carcinoma after many decades.

Sexual transmission of HBV occurs everywhere, but is more important in the developed countries, particularly in the promiscuous homosexual. The risk of transmission by heterosexual and homosexual contact increase with the number of partners and the duration of such relationships. HBV infection has occurred after artificial insemination. Semen donor screening is therefore obligatory.

Certain groups and occupations carry a high risk of infection. These include medical and paramedical personnel, staff of blood banks, dialysis units, medical laboratories and mental health institutions, barbers and sex workers. Dentists and doctors have been responsible for small outbreaks. In non-endemic countries like Britain HBV carriers are barred from invasive medical practice. Carriers are also not permitted to be medical students.

The only safe and effective measure for prevention is universal active immunization. Its success has been demonstrated in some highly endemic areas like Taiwan where the carrier rate fell from 18% in 1986 to 8% in 1993 following immunization. In 1992, the World Health Assembly recommended the integration of hepatitis B vaccine into the national immunization programmes of all nations by 1997. More than 80 countries have conformed. India is one of the few countries yet to initiate this measure mainly because of the high cost of imported vaccine. Now that the vaccine is manufactured in India, and is available at lower cost, it should be possible to include this in the national immunization schedule.

2. Perinatal transmission: HBV can be transmitted from carrier mothers to their babies during the perinatal period. Transmission probably occurs when maternal blood contaminates the mucous membranes of the new born during birth. Infection may also result from haematogenous transplacental transmission, breast-feeding and close postnatal contact between infant and the infected parent. Perinatal infection and infection during the first year of life have important consequences because 90% of these infants become chronic carriers, as compared to 10% of those infected after the age of 6 years. Such chronicity increases the risk of cirrhosis and hepatocellular carcinoma.

3. Sexual transmission: Since HBV is present in semen and vaginal secretions, therefore, it can be transmitted by sexual contact. Sexually promiscuous individuals

particularly male homosexuals are at very high risk. Most of the HBV infections are subclinical, particularly in childhood.

The course of acute HBV infection can be divided into three phases: preicteric, icteric and convalescent.

(A) Preicteric (prodromal) phase: After an incubation period of 6 weeks to 6 months patient develops malaise, anorexia, weakness, myalgia, nausea, vomiting and pain in the right upper abdominal quadrant. A minority of patients develop arthralgia, urticarial or maculopapular rash, polyarteritis nodosa and glomerulonephritis. These features may be related to circulating immune complexes.

(B) Icteric phase: Two days to two weeks following the initial symptoms patient develops jaundice, pale stools and dark urine (bilirubinuria). Hepatocellular damage is detectable biochemically before the onset of jaundice and persists after it has resolved.

(C) Convalescent phase: This phase is long and drawn out with malaise and fatigue lasting for several weeks. The duration of uncomplicated hepatitis is rarely more than 8-10 weeks, but mild symptoms may persist for more than one year. The incubation period is long (1-6 months). About 90-95% of adults with acute hepatitis B infection recover within 1-2 months of onset and eliminate the virus from the body within about 6 months remaining immune thereafter. Mortality is 0.5 -2% but may be more in post transfusion cases.

HBV infection occurs virtually in every country of the world. The carrier rate in India is estimated to be 5%. Mild cases that do not result in jaundice are termed anicteric. Less than 1% of the icteric cases die of fulminant hepatitis, 90-95% recover with complete regeneration of the damaged liver within 2-3 months. The remaining patients progress to chronic active hepatitis, cirrhosis and hepatocellular carcinoma. Hepatoma cells often contain HBV DNA, but the patient is usually negative for HBcAg and other indications of ongoing viral replication. Integration of HBV DNA fragments into the hepatocyte genome is a frequent event during HBV infection.

Hepatitis B carriers

HBV replicates within hepatocytes viral DNA exist in hepatocyte nucleus in the free extrachromosomal state or integrated with the cell chromosome. DNA is synthesized from an RNA template by reverse transcriptase.

About 5-10% of HBV infections result in chronic carrier state. The latter may be defined as persistence of HBsAg in the circulation for more than six months. Carriers are of two types:

1. Super carriers: They have HBeAg, high titres of HBsAg and DNA polymerase in their blood. HBV may also be demonstrable in their blood. Very minute amount of serum or blood from such carriers can transmit the infection.

2. Simple carriers: These are more common types of carriers who have low level of HBsAg and no HBeAg, HBV and DNA polymerase in the blood. They transmit the infection only when large volumes of blood are transferred as in blood transfusion.

TABLE 15
Serological Markers of Hepatitis B Infection

Clinical condition	Serological marker						
	HBsAg	HBeAg	Anti-HBs	Anti-HBe	Anti-HBc IgM	IgG	HBV DNA
Incubation period	+	+	-	-	-	-	+
Acute hepatitis	+	+	-	-	+	+	+
Chronic active hepatitis	+	+	-	-	+	+	+
Asymptomatic carrier state	+	-	-	+	-	+	-
Past infection	-	-	+	-	-	+	-
Immunization without infection	-	-	+	-	-	-	-

Prophylaxis

Measures for the control of HBV infection are the same as those for HIV infection i.e. screening of blood donors, use of sterile disposable syringes and needles by the medical personnel and parenteral drug users, reduction of the number of sexual partners, the use of condoms, etc. Medical personnel should wear gloves, gowns, masks and eyeglasses to prevent exposure to blood and body fluids, avoidance of mouth - pipetting, eating or smoking in the place of work and proper hand washing after work. Blood spills should be cleaned up with 2% glutaraldehyde or 0.5% sodium hypochlorite. Disposable equipments should be incinerated and other equipments should be properly sterilized.

Passive immunization: Hepatitis B immune globulin (HBIG) is prepared from donors with high titres of anti-HBs. It can be given in the doses of 300-500 IU intramuscularly after accidental exposure, as may occur by needlestick injury or by splashing of blood from an HBsAg positive patient. HBIG should be administered as early as possible after exposure and preferably within 48 hours. A second dose is usually given 4 weeks after the first. Passive immunization is also effective in reducing the risk of the carrier state in babies born to infectious mothers. HBIG must be given as early as possible but not later than 12 hours after birth. When this is repeated at monthly intervals for up to six months, the proportion of babies who become carriers can be reduced by about 70%.

Greater protection is provided by combined passive and active immunization in post exposure prophylaxis. It is advisable to give the injections into different sites. Babies also respond to vaccine. The protective efficacy of the combined treatment is 90%.

Active Immunization: Immunization against HBV is required for high risk individuals like:

- health care personnel especially those in direct contact with blood and sharp instruments.
- patients & health care personnel of institutions for the mentally retarded.
- patients requiring repeated transfusion of blood and blood products.

- patients on maintenance dialysis.
- patients receiving prolonged inpatient treatment
- patients who require frequent tissue penetration
- parenteral drug users
- sexually promiscuous individuals and prostitutes, and
- spouses of those known to be infected with HBV.

Following vaccines are available:

1. Plasma-derived hepatitis B vaccine: It consists of purified 22 nm particles of HBsAg, prepared from the plasma of symptomless carriers. The particles are separated by ultracentrifugation and treated with proteinase, 8 M urea and formaldehyde. The chemical treatment inactivates HBV, HIV and other contaminating viruses. The product is immunogenic and safe. This vaccine is still being produced and used, particularly in developing countries where the need is greatest.

2. Recombinant yeast hepatitis B vaccine: It is produced by cloning the HBsAg gene in yeasts *Saccharomyces cerevisiae* and the HBsAg particles produced are extracted and purified for use as vaccine. This vaccine is safe, antigenic, free from side effects and as immunogenic as plasma-derived vaccine.

Both vaccines are absorbed with aluminium hydroxide as adjuvant, stored in cold but not frozen and are injected intramuscularly into the deltoide regions in a course of three doses given at 0, 1 and 6 months. Care should be taken to avoid injection into fat as this may produce poorer seroconversion rates.

3. Recombinant Chinese hamster ovary (CHO) cell hepatitis vaccine: Expression system of CHO cells has been successfully used and the product is commercially available. This is the first vaccine using mammalian cell expression system.

4. Synthetic peptide vaccines: As the name indicates these are chemically synthesized polypeptide vaccines. These are safe and cheap. These are still under experimental stage.

5. Hybrid virus vaccine: Potential live vaccines using recombinant vaccinia virus have been prepared for hepatitis B, influenza, rabies, epsteinbarr and human immunodeficiency viruses. Recombinant vaccines can be generated by incorporating foreign genes (HBsAg sequences in case of HBV) into vaccinia virus DNA. Animal cells are first infected with vaccinia virus. Subsequently, a plasmid containing the foreign gene of interest and promotor and thymidine kinase sequences from vaccinia virus is introduced. During replication of vaccinia virus DNA, the plasmid sequences are also replicated and chimeric viral DNA containing the foreign gene is produced. Recombinant vaccinia virus expresses proteins (HBsAg in case of HBV) encoded by foreign gene. The advantages of vaccinia virus recombinant vaccine include low cost, long shelf-life and possible use of polyvalent antigens.

Hepatitis C Virus (HCV)

HCV infection is seen only in humans. The source of infection is the large number of carriers about 200 million world wide. A virus of growing importance, hepatitis C virus,

belongs to the family Flaviviridae. It measures 30-60 nm in diameter. It can be inactivated by exposure to chloroform, ether and other organic solvents and by detergents. Its genome consists of a single 9.4 kb molecule of ssRNA of positive polarity (Table). A comparison of HCV genomic sequences from around the world has shown substantial heterogeneity of nucleotide sequences within several regions of the viral genomes. On the basis of these genomic differences, HCV has been classified into 11 genotypes and each genotype has several subtypes. This makes vaccine development difficult. Only a polyvalent vaccine containing several genotypes is likely to be protective. HCV is difficult to grow in tissue culture. It has been proposed that hepatitis C & G should be placed in a separate genus of the family Flaviviridae to be called *Hepacivirus*.

HCV transmission occurs by needlestick injuries or cuts with sharps, use of contaminated needles and syringes, transfusion of unscreened blood and sexual intercourse. HCV can be transmitted in utero, during parturition and by breast milk. Transmission by saliva and tears cannot be excluded. HCV transmission from a conjunctival blood splash has also been reported. Infection is mainly by blood transfusion and other modes of contact with infected blood/blood products. HCV is reported to be an important cause of chronic liver disease in South India.

Incubation period of hepatitis C averages 6-8 weeks though it may range upto several months. About 75% infections are subclinical. The danger from hepatitis C is not the acute disease but the persistence of infection. As compared to hepatitis B, clinical infection with hepatitis C is generally less severe, has shorter preicteric period, milder symptoms, absent or less marked jaundice, somewhat lower serum alanine aminotransferase (ALT) levels and the case-fatality rate from fulminant hepatitis is 1% or less.

However, 85% or more of the acute HCV infections become chronic. The affected individuals have persistence of the virus in their blood, elevated ALT levels for at least a year or two or more and they are at risk, just as in hepatitis B, of developing cirrhosis and hepatocellular carcinoma.

Diagnosis of HCV infection can be established by detection of anti-HCV by ELISA, viral genome by PCR, and by immunofluorescence and in situ hybridization on biopsy and autopsy specimens.

Prophylaxis

HCV infection can be prevented by screening of blood donors, avoidance of use of unsterile needles for intravenous drug abuse, tattooing and for medical and dental procedures. Many of the public health measures adopted to prevent transmission of human immunodeficiency virus and HBV by parenteral routes will assist efforts at controlling HCV.

Hepatitis D Virus (HDV)

In 1977 Rizzetto and Colleagues in Italy identified a new viral antigen in the liver cell nuclei of patients infected with hepatitis B virus. The HDV is a defective satellite virus requiring HBV as helper virus. It is spherical, 36-38 nm in diameter with HBsAg coat & HDag nucleoprotein. The genome consists of a single small circular molecule of minus sense RNA of 1.7 kilobase pairs. It encodes its own nucleoproteins, the delta antigen or

HDAg, but the outer capsid (HBsAg) of HDV virion is encoded by the genome HBV coinfected the same cell. Replication of HDV requires the concomitant expression of HBV gene products, therefore, HBV is necessary for the production of HDV virions. It belongs to the genus *Deltavirus*. Its mode of transmission is same for HBV. Two types of infection viz coinfection and super infection. In coinfection delta and HBV are transmitted together at the same time. In superinfection delta infection occurring in a person already harbouring HBV. Coinfection clinically presents mild to fulminant disease super infection leads to serious and chronic illness.

Pathogenesis

HDV is transmitted principally by blood and blood products, but also by sexual contact. Vertical transmission is also possible.

Two types of HDV infections are possible:

1. Simultaneous coinfection with HBV & HDV in the same inoculum. It most commonly results from parenteral transmission, for example, in intravenous drug users. The clinical and biochemical features of such infection resemble those of acute hepatitis B alone. However, coinfection with HBV and HDV may be more severe than the disease caused by HBV alone.

2. Superinfection of an HBsAg carrier by HDV. It is commoner and more serious because a large number of hepatocytes are already producing HBsAg, and HDV can replicate without delay with a relatively short incubation period. It leads to severe liver damage, fulminant HBsAg positive hepatitis and elevated mortality (upto 20%)

In simultaneous acute HBV & HDV infections, IgM anti-HBc will be detectable, while in acute HDV infection superimposed on chronic HBV infections, anti-HBc will be of IgG class.

Laboratory Diagnosis

In patients with HBV-HDV coinfections, shortly before the end of incubation period, HBsAg appears in the serum and towards the end of incubation period HDAg appears which can be detected by ELISA or immunoblotting and HDV RNA can be detected by hybridization to a radio labeled RNA probe. In the later stages of acute disease, anti-HD IgM appears followed by anti-HDIgG. These can be detected by ELISA.

Prophylaxis

HDV infection can be prevented by prevention of coinfection with HBV or of superinfection of HBV carriers and hence requires all the measures that apply to the prevention of HBV infection, including vaccination against HBV, HDV vaccine might be of use in patients chronically infected with HBV.

Hepatitis E Virus (HEV)

Hepatitis E virus belongs to the family Caliciviridae. Virions of HEV are spherical,

non enveloped and 27-38 nm in diameter. They possess single-stranded positive sense RNA genome of 7.6 kb which is surrounded by icosahedral capsid with characteristic surface depressions. HEV is a spherical non enveloped virus, 32-34 nm in diameter with single stranded RNA genome. The surface of virion shows indentation and spikes. The virus is very labile.

Pathogenesis

A substantial proportion of cases of acute viral hepatitis occurring in young to middle-aged adults in Asia and the Indian subcontinent appear to be caused by HEV. Hepatitis E has been shown to occur in epidemics, endemics and sporadic forms almost exclusively in the less developed parts of the world. It is primarily associated with ingestion of faecally contaminated drinking water. It was first documented in New Delhi, India, in 1955, when 29,000 cases of icteric hepatitis were identified following widespread faecal contamination of the city's drinking water. A similar epidemic of hepatitis E occurred between December 1975 and January 1976 in Ahmedabad city, India, again due to contaminated water supplies. Many similar water-borne outbreaks have been recorded subsequently from Indian subcontinent (Nepal and Pakistan), Southeast Asia (Burma and Indonesia), Central Asia (Kirgiz Republic and China), Africa (Algeria, Ivory coast, Chad, Sudan & Somalia) and North America (Mexico).

Incubation period of hepatitis E ranges from 2-8 weeks, with an average of 5-6 weeks. It occurs predominantly in the 15-40 years age group. Clinically, the disease closely resembles that of hepatitis A. however, bilirubin levels tend to be higher and jaundice deeper and more prolonged. The case-fatality rate is 0.5-3% but in infected pregnant women it varies from 10-20%. Like hepatitis A, hepatitis E does not progress to chronic hepatitis, cirrhosis, cancer or carrier state. In contrast to HAV, HEV has considerable implications in pregnancy. It may cause intrauterine and perinatal infections. HEV infection during pregnancy may cause a high rate of abortion and intrauterine death and increase perinatal mortality in babies born to women with fulminant hepatitis.

Prophylaxis

Hepatitis E can be prevented by improved standards of sanitation and provision of chlorinated water throughout the developing world. During the epidemic, take boiled water and only cooked food. No vaccine or effective antiviral drugs exist.

Hepatitis G Virus (HGV)

Hepatitis G virus represents a newly discovered virus. It has been proposed that hepatitis C and G should be placed in a separate genus of the family Flaviviridae to be called *Hepacivirus*. HGV is distinct from HCV and newly discovered GBV-A and GBV-B agents, however, GBV-C represents an isolate of HGV. Both the GBV-A and GBV-B viruses are considered animal viruses while HGV/GBV-C has been found in humans and in experimentally infected animals. HGV was cloned from the serum of a patient suffering from chronic hepatitis who had a history of parenteral exposure. He was negative for HBV and initially also negative for HCV, but later on was found to have an HCV variant

genotype IV. In order to identify the new virus, nucleic acid from the plasma of the patient was first amplified using a modified polymerase chain reaction and then cloned into an expression vector. The recognition of the clone producing viral antigen was done by immunological methods.

The genome of HGV consists of 9.4 kb molecule of ssRNA of positive polarity. Its structure resembles that of HCV, but it has <25% homology with HCV. HGV replicates in peripheral blood cells, however, its replication in the liver is not known. The virus is transmitted parentally (exposure to blood through transfusions, haemodialysis, or sharing equipment in injecting drugs use), sexually and for mother to child. More than 30% of transfusion recipients and upto 80% of injecting drugs users are HGV marker positive. HGV and human immunodeficiency virus (HIV) share same infection routes, and a significant proportion of HIV-infected subjects are HGV-coinfected.

The virus is present worldwide. Majority of the individuals with HGV infection have no detectable evidence of liver disease. There have been, however, cases of acute, fulminant and chronic hepatitis where HGV is presently the only explanation for their liver disease. There is no evidence of a causal relationship between HGV infection and hepatocellular carcinoma. HGV infection results frequently in chronic viraemia. It often subsides after several years and anti-HGenv antibody develops.

HGV infection is mainly detected by reverse transcriptase polymerase chain reaction (RT-PCR). Recently, an immunoassay has been developed to detect anti-HGenv, Serum HGV RNA indicates viraemia, whereas anti-HGenv is associated with recovery. These can be found respectively in <2% and 9% of healthy blood donors. Prevalence increases in association with HCV or HBV infection. HGV infection can be prevented by employing the same measures as for HBV, HCV and HIV.

11

ARCHAEA

The term Archaea (Greek *archaios* = ancient) is a group of prokaryotes which is quite different from Eubacteria in several morphological and biochemical traits. The archaeobacteria are not a homogenous group but is a collection of disparate phenotypes: the methanogens, the extreme halophiles (organism that can grow in concentrated salt solutions) and extreme thermophilic sulphur metabolizing species.

Morphologically it can be spherical, rod-shaped, spiral, lobed, plate shaped, irregularly shaped or pleomorphic. Some are single celled, whereas others form filaments or aggregates. They range in diameter from 0.1 to 15 μm and some can grow in 200 μm in length.

Archaea are generally found in extreme aquatic and terrestrial habitats. They are often present in anaerobic, hypersaline or high-temperature environments and also in cold environments. Archaea constitute up to 34% of prokaryotic biomass in Coastal Antarctic surface waters and few as a symbiont in animal digestive systems.

PHYLOGENY

Phylogenetically the domain Archaea tree splits into two major phyla called the Crenarchaeota and Euryarchaeota. Two other phyla called Korarchaeota and Nanoarchaeota branch off close to the root. Phyla Crenarchaeota contain mostly hyperthermophilic species whose optimum growth temperature is greater than 80°C. These hyperthermophiles are chemolithotrophic autotrophs and these organisms are the only primary producers in these harsh environments. The 16S rRNA sequencing suggests that these organisms are more slowly evolving than other lineages in the domain.

Phyla Euryarchaeota includes methanogenic Archaea-whose metabolism is linked

to the production of methane (CH_4) and extreme halophiles. Other groups of euryarchaeotes include hyperthermophiles *Thermococcus* and *Pyrococcus* and methanogen *Methanopyrus* and the cell wall less prokaryote *Thermoplasma*.

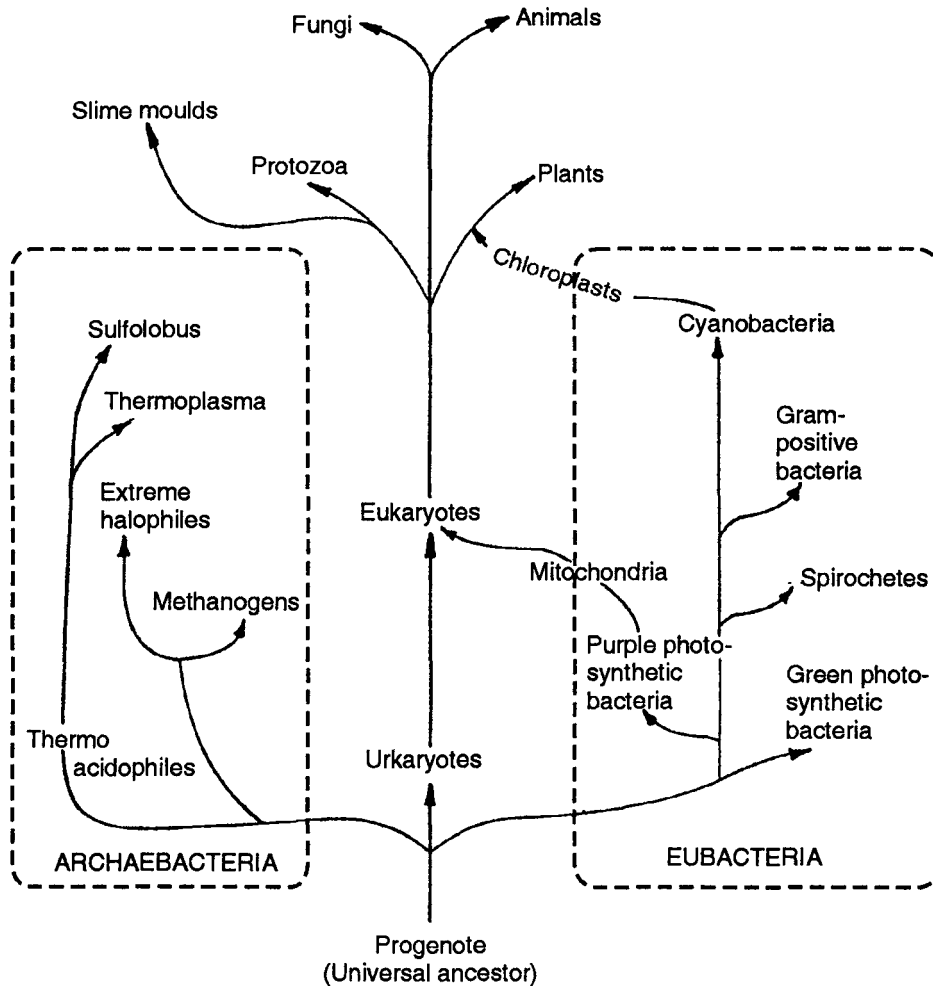

Fig. 1 : The phylogenetic tree showing the evolution of archaeobacteria, eubacteria and eukaryotes

The korarchaeota was originally discovered by sampling of rRNA genes from organism inhabiting in unusual Yellowstone hot spring. This group is not yet officially recognized in taxonomy but clearly branch on the archaeae tree close to the root.

The Nanoarchaeota are the latest addition to the domain archaea. The only genus is *Nanoarchaeum* which is small parasitic prokaryote which lives attached to the cells of *Ignicoccus* (a crenarchaeote).

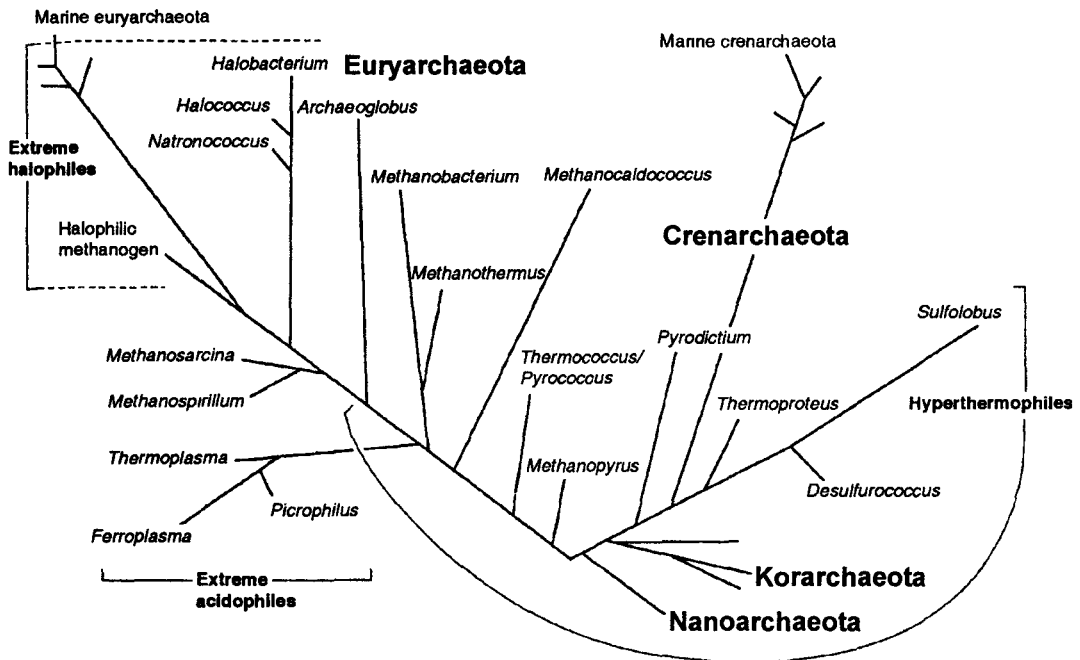

Fig. 2 : Phylogenetic tree of the *Archaea* based on 16S ribosomal RNA

GENERAL CHARACTERISTICS

- (1) The archaebacteria (archaios = ancient and bakterion = a small rod) is a unique group which is diverse in its morphology and physiology from eubacteria and eukaryote.
- (2) They usually occur in extreme environments like highly saline or very high temperature conditions. Sometimes they are found in extreme cold environments. The extreme environment conditions include high temperature, low temperature, low acidic pH value, high alkaline value, high salt concentration, low water availability, high irradiation which include hot springs, salt lakes, antarctic desert soils.
- (3) They are Gram positive or Gram negative and may be spherical, rod shaped, lobed, spiral or plate like or pleomorphic. The size ranges from 0.1-15 μm .
- (4) They multiply by binary fission, budding, fragmentation or other mechanisms.
- (5) Nutritionally they are either aerobic, facultative anaerobic or strictly anaerobic, chemolithoautotroph to organotrophs. The autotroph has the ability to fix CO_2 by reverse TCA cycle or by reductive acetyl CoA pathway-leading to production of glucose via pyruvate.
- (6) The Gram positive forms have a thick wall made up of N-acetylglucosamine and L-amino acids while N-acetyl muramic acid and D-amino acids are absent and hence they are resistant to lysozyme and penicillin. The Gram negative

- archaebacteria have a relatively thick protein or glycoprotein cell wall but the outer membrane is absent.
- (7) The plasma membrane of archaea differs from that of eubacteria and eukaryote in having branched chain hydrocarbon attached to glycerol, connected by ether links (not straight chain fatty acids connected by ester links as in eubacteria).
 - (8) The archaebacterial chromosome is a single circular DNA molecule as in eubacteria but smaller in length (mol. weight of 0.8 to 1.1×10^9 daltons, compared to 2.5×10^9 dalton).
 - (9) The T ψ C arm of archaeal tRNA lacks thymine and contains pseudouridine or 1-methyl pseudouridine.
 - (10) The first amino acid to initiate a new polypeptide chain is methionine in archaebacteria where as it is N-formylmethionine in eubacteria.
 - (11) The eubacteria are sensitive to chloramphenicol while the archaebacteria are not. While the diphtheria toxin affects archaebacteria but not eubacteria.
 - (12) The variation in G + C content is great (21-68% of molecular weight)
 - (13) The archaebacteria have few plasmids.
 - (14) The archaebacterial mRNA is more similar to eubacteria than to eukaryotic mRNA.
 - (15) Some methanogens have histone like protein that bends with DNA to form nucleosome like structure.
 - (16) The archaebacteria, specially methanogens contain unusual coenzymes which do not occur in eubacteria like coenzyme F420, F430, Methanofuran, Methanopterin, and co-enzyme -M.
 - (17) The extreme halophiles are only photosynthetic archaebacteria and convert light energy into chemical energy by means of a proton pump based on a pigment bacteriorhodopsin.

THE ARCHAEBACTERIAL CELL WALL

As we know that archaebacteria are either Gram + ve or Gram -ve. Thus there is considerable variety in the cell wall of archaebacteria. The cell wall structurally and chemically differ from that of eubacteria. The Gram positive archaebacteria have a single uniform thick homogenous cell wall layer like of eubacteria while the gram negative archaebacteria lack the outer membrane and complex peptidoglycan network like that of Gram negative eubacteria.

Chemically the archaebacterial cell wall differ from eubacteria. They do not contain muramic acid and D-amino acid (characteristic feature of eubacterial peptidoglycan) but contain NAG (N-acetyl glucosamine) and L-amino acid. Some methanogens like *Methanobacterium* contain a peptidoglycan like material called pseudopeptidoglycan or pseudomurin which contains an alternating repeats of N-acetyl glucosamine and N-acetyltalosamino uronic acid (unique to archaebacteria) which has L-amino acids in its

cross links and β (1-3) glycosidic bonds instead of β (1-4) glycosidic bonds. Because of their structural difference the cell walls of archaebacteria are resistant to the action of lysozyme.

Methanosarcina sps. contain a complex polysaccharide the major sugar in this being galactosamine, glucuronic acid and glucose. *Halococcus* an extreme halophile contains a sulphated polysaccharide made of sugars glucose, mannose and galactose. Along with this a great amount of negatively charged acidic amino acids which serve to balance the abundance of positive charges generated by the high concentration of sodium in the organism's environment (about 20-25% NaCl).

Methanococcus and *Methanomicrobium* lack carbohydrates in the cell walls and contain only protein. *Sulfolobus* cell walls are made of glycoprotein and can remain, intact in boiling detergent solutions. The cell wall of *Pyrodictium* (which can withstand 110°C the most thermophilic organism) is also made of glycoprotein.

In the Gram negative archaebacteria the outer membrane is absent and have a relatively thick protein and glycoprotein outside the plasma membrane. The layer is 20- 40 nm. The chemical content varies considerably some methanogens, *Halobacterium* and several extreme thermophiles viz. *Sulfolobus*, *Thermoproteus* have glycoproteins in their walls. In contrast, other methanogens *Methanococcus*, *Methanomicrobium* and *Desulfurococcus* have protein walls.

ARCHAEBACTERIAL LIPIDS AND MEMBRANE

The plasma membrane of archaebacteria differs from that of eubacteria and eukaryotes. The plasma membrane lipids of archaebacteria have branched chain hydrocarbon attached to glycerol by ether links rather than fatty acid connected by ester links as in eubacteria. Sometimes two glycerol groups are linked to form an extremely long tetraethers. Glycerol diethers and glycerol tetraethers are major classes of lipid present in archaebacteria.

The lipids are polar lipids which are present in archaebacterial membrane like phospholipids, sulfolipids and glycolipids. About 7-30% of membrane lipids are nonpolar lipids (the derivative of squalene). The C_{20} diethers can be used to make a regular bilayer membrane while a more rigid monolayer membrane is constructed of C_{40} tetraethers lipids which increases the membrane's mechanical strength and resistance to chemical agent.

In thermoacidophiles one or two cyclopentane ring commonly occurs in C_{40} chains and two -OH (adjacent) groups on glycerol moiety are ether linked to these hydrocarbon chains. Thus archaebacterial membranes may contain a mix of diethers, tetraethers and other lipids like thermoacidophiles contain many dibiphytanyl tetraethers, halophiles contain many diphytanyl diethers and methanogens contain both diphytanyl diethers and dibiphytanyl tetra ethers. The presence of ether linked lipid is such a unique characteristic of archaebacteria that this distinctive feature has been used as a biomarker for detecting archaebacteria in paleontological studies of rocks, sediments cores and other fossil materials.

- (2) All archaea can oxidize pyruvate to acetyl CoA. They lack pyruvate dehydrogenase complex but have pyruvate oxidoreductase for this purpose.
- (3) Thermophiles and halophiles do have TCA cycle but methanogen lack it.
- (4) In protein synthesis the 1st-NH₂ acid to initiate polypeptide chain is methionine in archaeobacteria whereas it is N-formylmethionine in eubacteria.

TABLE 1
Characteristics of the Major Archaeal Groups

Group	General characteristics	Representative Genera
Methanogenic archaea	Strict anaerobes. Methane is the major metabolic end product. S may be reduced to H ₂ S without yielding energy production. Cells possess coenzyme M, factors 420 and 430, and methanopterin.	<i>Methanobacterium</i> <i>Methanococcus</i> <i>Methanomicrobium</i> <i>Methanosarcina</i>
Archaea sulfate reducers	Irregular gram-negative coccoid cells. H ₂ S formed from thiosulfate and sulfate. Autotrophic growth with thiosulfate and H ₂ . Can grow heterotrophically. Traces of methane also formed. Extremely thermophilic and strictly anaerobic. Possess factor 420 and methanopterin but not coenzyme M or factor 430.	<i>Archaeoglobus</i>
Extremely halophilic archaea	Coccoid or irregularly shaped rods. Gram-negative or gram-positive, primarily aerobic chemoorganotrophs. Require high sodium chloride concentrations for growth (>1.5 M). Colonies are various shades of red. Neutrophilic or alkalophilic. Mesophilic or slightly thermophilic. Some species contain bacteriorhodopsin and use light for ATP synthesis.	<i>Halobacterium</i> <i>Halococcus</i> <i>Natronobacterium</i>
Cell wall-less archaea	Pleomorphic cells lacking a cell wall. Thermoacidophilic and chemoorganotrophic. Facultatively anaerobic. Plasma membrane contains a mannose-rich glycoprotein and a lipoglycan.	<i>Thermoplasma</i>
Extremely thermophilic S ⁰ -metabolizers	Gram-negative rods, filaments, or cocci. Obligately thermophilic (optimum growth temperature between 70-110°C). Usually strict anaerobes but may be aerobic or facultative. Acidophilic or neutrophilic. Autotrophic or heterotrophic. Most are sulfur metabolizers. S ⁰ reduced to H ₂ S anaerobically; H ₂ S or S ⁰ oxidized to H ₂ SO ₄ aerobically.	<i>Desulfurococcus</i> <i>Pyrodictium</i> <i>Pyrococcus</i> <i>Sulfolobus</i> <i>Thermococcus</i> <i>Thermoproteus</i>

Classification

The first edition of Bergey's manual divided the archaea into five major groups based on physiological and morphological difference (Table 1). The second edition of Bergey's Manual divides the archaea into two phyla the Crenarchaeota and Euryarchaeota each with several orders. The classification was based on rRNA data. The term Crenarchaeota [Greek Crene, spring or fount and archaeos] and Euryarchaeota [Greek Eurus wide and = archaios = ancient or primitive] divided the archaea at the phyla level. The Crenarchaeota are thought to resemble the ancestor of the archaea and almost all the species are thermophiles or hyperthermophiles. The phylum Crenarchaeota is divided into one class, Thermoprotei and four orders Thermoproteales, Sulfolobales, Desulfurococcales and Caldisphaerales.

Thermoproteales contains Gram-ve, anaerobic to facultative hyperthermophilic rods. They often grow chemolithoautotrophically by reducing sulphur to hydrogen sulfide. Members of the order Sulfolobales are coccus shaped thermoacidophiles. The order Desulfurococcales contain Gram negative coccoid or disk shaped hyperthermophiles. They grow either chemolithotrophically by hydrogen oxidation or organotrophically by either fermentation or respiration with sulphur as the electron acceptor.

The Euryarchaeotes are given the name because they occupy different ecological niches and have a variety of metabolic patterns. This phylum is very diverse with seven classes. (Methanobacteria, Methanococci, Halobacteria, Thermoplasmata, Thermococci, Archaeoglobi and Methanopyri), nine orders and 15 families. Methanogens are the dominant physiological group and largest group with a great practical importance because methane is a clean burning fuel and an excellent energy source.

PHYLUM-CRENARCHAEOTA

Most of the Crenarchaeotes are extremely thermophilic and many are acidophilic and sulphur dependent. Almost all are strict anaerobes. They grow in geothermally heated water or soils that contain elemental sulphur. The sulphur may be used either as an electron acceptor in aerobic respiration or as an e^- source by lithotrophs. The members are scattered all over the world for eg. the sulphur rich hot springs in Yellowstone National park, Wyoming and water surrounding areas of submarine volcanic activity. Such habitats are called Solfatara. These archaea can be very thermophilic and often are classified as hyperthermophiles. The phylum include a single class Thermoprotei, with 4 orders, Thermoproteales, Caldisphaerales, Desulfurococcales and sulfolobales.

Thermoproteus the member of order Thermoproteales is a long thin rod that can be bent or branched. Its cell wall is composed of glycoprotein. It is strict anaerobic and grows at temperature from 70-97°C and pH values between 2.5 to 6.5. It is found in hot springs and other hot aquatic habitats rich in sulfur. It can grow organotrophically and oxidize glucose, amino acids, alcohols and organic acids with elemental sulfur as the electron acceptor. CO or CO₂ act as sole carbon source.

Sulfolobus is a facultative chemoautotroph found extensively all over the world in hot acid springs and soils. The cells are irregularly lobate spherical. Temperature optima

TABLE 2
Some Characteristics of Representative Genera of Methanogens

Genus	Morphology	Motility	% G+C ratio	Wall composition	Gram reaction	Substrate used
1. <i>Methanobacterium</i>	Long rods often forming filaments	—	32 - 61%	Pseudomurin	+ to variable	H ₂ +CO ₂ , formate
2. <i>Methanococcus</i>	Pleomorphic, irregular cocci	Through one flagellar tuft	29 - 34%	Protein	—	H ₂ + CO ₂ , formate
3. <i>Methanomicrobium</i>	Short rods	Through single polar flagellum	45 - 49%	Protein	Gram - ve	H ₂ + CO ₂ , formate
4. <i>Methanogenium</i>	Pleomorphic cocci	Through peritrichous	52 - 61%	Protein or glycoprotein	Gram - ve	H ₂ + CO ₂ , formate
5. <i>Methanospirillum</i>	Curved rods or spirilla	Through polar flagella	45 - 50%	Protein	Gram - ve	H ₂ + CO ₂ , formate
6. <i>Methanosarcina</i>	Cocci in clusters	—	36 - 43%	Heteropolysaccharides or protein	Gram + ve or variable	H ₂ + CO ₂ , methanol, methylamines, acetate
7. <i>Methanothermus</i>	Straight to slightly curved rods	+	33%	Pseudomurin with an outer protein sulphur layer	+	H ₂ + CO ₂

for growth vary among isolates from 63-80°C, pH values 1-5 (Optimum 2). Although it can grow on organic compounds (organotrophically) but in its natural habitats it probably grows as a respiratory chemoautotroph. Geothermal steam or hot water leaches much amounts of iron and sulphide which is rapidly oxidized to elemental sulphur by oxygen or ferric ion, either chemically or biologically. This bacterium rapidly oxidizes H₂S. This ability of *Sulfolobus* to oxidize Fe⁺² to Fe⁺³ anaerobically has been used quite successfully in high temperature bioleaching of iron and copper ores. *Sulfolobus* cells are spherical, Gram - ve, aerobic irregularly lobed and cell walls are mainly composed of protein. Cells adhere tightly to sulphur crystals where they can be visualized microscopically using fluorescent dyes. Their cell wall contains lipoprotein and carbohydrate but lacks peptidoglycan. Oxygen is the normal electron acceptor. Sugar and amino acid such as glutamate also serve as carbon and energy sources. They are generally classified as thermoacidophiles.

***Pyrodictium*:** It is a sub-marine volcanic extreme thermophile which is of great interest because of its ability to grow at temperature upto 110°C (Optimum 105°C). Cells of *Pyrodictium* are irregularly disc-shaped and grow in cultures as a mold like layer upon sulphur crystals on the medium. The cell mass consists of a network of fibres to which cells are attached. The fibres are hollow and consist of proteinaceous subunits similar to that of flagellin protein of eubacterial flagellum. It is strict anaerobe that grows lithotrophically on H₂ and S at 82-110°C. The cell envelope consists of glycoprotein.

***Picrophilus*:** The genus was isolated from moderately hot solfataric fields in Japan. It lacks a regular cell wall but has an S-layer outside its plasma membrane. The cells grows as irregularly shaped cocci, 1.5 µm in diameter and have large cytoplasmic cavities that are not membrane bounded. The genus is aerobic and grows between 47-65°C. The optimum pH is 0.7

Phylum-Euryarchaeota

This phylum is very diverse phylum with many classes (nine according to 2nd edition of Bergey's manual), viz. Methanobacteria, Methanococci, Methanomicrobia, Halobacteria, Thermoplasmata, Thermococci, Archaeoglobi, Methanopyri.

Methanogens occur in various anaerobic habitats rich in organic matter with non-methanogenic bacteria ferment to produce H₂ and CO₂. Thus the methanogens form the consortia in association with other microorganisms which not only provide CO₂ and fatty acids required. The habitat like marshes, swamps, pond and lake mud marine sediments, the intestinal tract of human and animals, the rumen of cattle and anaerobic sludge digesters in sewage treatment systems are ideal for these archaeobacteria. These microbes are unable to use carbohydrate, proteins or other complex organic substrates.

The methanogens obtain energy by converting CO₂, H₂, formate, methanol, acetate and other compounds to produce either methane or CO₂. This is the largest group of archaea which differ greatly in overall shape, 16srRNA sequence, cell wall chemistry and structure, membrane lipids. For example methanogens construct three different types of cell wall. The most complex is that of group I which is rigid and composed chiefly of pseudomurin (it contain N-acetyl talosaminuronic acid instead of N-acetylmuramic

acid and lack D-amino acids). In appearance the wall resembles those of Gram + ve eubacteria. In group II the wall is flexible and composed chiefly of proteins with traces of glucosamine. While the group III has the most complex cell wall. It is flexible composed of at least two layers, an inner electron dense of unknown chemistry and outer one appearing like a membrane in cross section but composed entirely of protein.

The order Methanobacteriales consists of the genera *Methanobacterium*, *Methanobrevibacter*, *Methanosphaera* and *Methanothermus*. The Methanomicrobiales contains sarcinoid forms and some spirilla. The sarcinae can utilize acetate and sometimes methyl amines for methane production. They contain cytochrome b or c or both. The most unusual methanogenic group is the genus *Methanopyrus* which is extremely thermophilic, rod shaped methanogen from marine hydrothermal vent. This genus occupies the deepest and most ancient branch of euryarchaeotes.

The metabolism of these methanogen is unusual. They contain unique cofactors tetrahydromethanopterin, methanofuran, coenzyme M (all three not found in eubacteria) coenzyme F₄₂₀ and coenzyme F₄₃₀. It is suggested that ATP synthesis is linked with methanogenesis by electron transport, protein pumping and a chemiosmotic mechanism.

The group methanogenic archaea are potentially of great practical importance because methane is a clean burning fuel and an excellent energy source. The sewage treatment plants uses the methane, produced as a source of energy for heat and electricity.

In contrast the methanogenesis can also be a ecological problem. It absorb IR radiation and is a green house gas and this significantly promote future global warming.

Halobacteria

The extreme halophiles or halobacteria (class Halobacteria) is another group of archaea, currently with 15 genera. It has a single family Halobacteriaceae. They are aerobic chemoheterotrophs and require complex nutrients usually proteins and amino acids for growth. All the members of this family are obligate halophiles growing in media containing at least 15% NaCl. These members are found in the ecosystem which have extremely high NaCl concentration like salt lakes, the dead sea and salt preserved foods. The salt lakes occur in arid regions where evaporation exceeds fresh water inflow, or a lake which is fed by a salt spring. The cell wall of these organism is so dependent on the presence of NaCl that it disintegrate when NaCl concentration drops to about 1.5 M. The cell wall of *Halococcus* are composed of a complex heteropolysaccharide which is stable even at low salt concentration. The major component of cell wall of *Halobacterium* is a large acidic glycol protein. Its glycan component consist of 22-24 disaccharide linked via - O - glycosidic bond to threonine residues, 12-14 trisaccharide. Also o-linked to threonine and a single heterooligosaccharide in N-glycosidic linkage to asparagine. In addition to the glycoprotein the cell envelope contains nonglycosylated protein and glycolipid. They can also grow in food products such as salted fish and cause spoilage. They can reach such high population levels that salts lakes, salterns and salted fish actually turn red. The best studied member of the family is *Halobacterium salinarium* which is especial because it can trap light energy photosynthetically with the help of

a special pigment called bacteriorhodopsin. Bacteriorhodopsin is a protein pigment, because of its functional similarity to the visual pigment of eye called rhodopsin, conjugated to bacteriorhodopsin is a molecule of retinal, a carotene like molecule which can absorb light and catalyse the transfer of protons across the cytoplasmic membrane. The cell membrane of *Halobacterium* appears purple due to the presence of the pigment bacteriorhodopsin. When a cell containing the pigment are exposed to light the pigment bleaches. During this bleaching H^+ (protons) are extruded to the outside of the membrane and generate a proton motive force which drives ATP synthesis. The absorption spectra of bacteriorhodopsin appears at 570 nm. The *Halobacteria* also contain cytochrome and ferredoxins. The genus *Halobacterium* has four rhodopsins each with separate function. Halorhodopsin uses light energy to transport chloride ions into the cell and maintain a 4-5 M intracellular KCl concentration. Two other rhodopsin act as photoreceptor one for red and one for blue light.

The halobacteria are Gram negative with the shape ranges from rod to disc shaped, polarly flagellated cells viz. *Halobacterium* or immotile cocci (*Halococcus*). The colonies are red to orange in colour because of carotene like pigments.

The genome of *Halobacterium* and *Halococcus* contain two components with different percentage of G + C values. Majority of DNA has a G + C content of 66-68%. The total genome size of *Halobacterium* is 2.5×10^9 which contains a large number of different repeated sequences upto 5,000 bp in length.

The group thermococcales are strictly anaerobic and can reduce sulfur to sulfide. They are motile and have optimum growth temperature 88-100°C. It contains two genera *Thermococcus* and *Pyrococcus*. This group is also known as extremely thermophilic S^0 metabolizers.

The group Archaeoglobales has a single family with single genus *Archaeoglobus*. This group is also known as sulfate reducing archaea. The organism is Gram -ve, irregular coccoid. Cells with cell wall containing glycoprotein subunits. It can extract electron from a variety of electron donors (like H_2 , lactate, glucose) and reduce sulfate, sulfite or thiosulfate to sulfide. The species is extremely thermophilic (optimum 83°C). It possess the methanogen, coenzyme F_{420} and methanopterin.

EVOLUTION

Evolutionarily all the organism of the group archaea is assumed to be descendent from a common ancestor the progenote (the organism might be primitive, cellular, with rudimentary not well coordinated translation apparatus or might be an archaebacterium). As a group they are collection of diverse groups of organism. The unifying feature being their adaptation to extremes of environmental conditions like extreme pH, temperature, salinity. Considering that early earth had such extreme environmental condition archaebacteria appears to be the early forms of life on earth. It is suggested that archaebacteria are more primitive than eubacteria and evolved at slower rate than both i.e. the eubacteria and eukaryotes.

MYCOPLASMA

In living organisms, some diseases are caused by very small microorganism called Mycoplasma. These organism are the smallest free living cell known much similar to other microorganism like bacteria, chlamydea, rickettsia and viruses.

Mycoplasmas and prokaryotes, without cell wall have been placed under the class mollicutes (Latin mollis = soft, pliable + cutis = stain) and the order Mycoplasmatales. Mycoplasmas or mollicutes (soft skin) are without cell wall and are bounded by triple layered membrane. They are smallest microorganism which have been known to cause a number of diseases in animals and human being. Louis Pasteur first noticed them while observing the causative agent of pleuropneumonia in culture. He was unable to isolate them in a pure culture medium. Nocard and Roux (1898) of Pasteur's laboratory cultured the microorganism in media containing serum and demonstrated that the pleomorphic microbes could produce the disease in inoculated healthy cattle. These were pleomorphic and were called PPLO (Pleuropneumonia like organism). This organism was later on given the name *Asterococcus mycoides* by Borrel *et al* (1910). Nowak (1929) put *Asterococcus mycoides* under the genus *Mycoplasma*. All such organisms are now called mycoplasmas.

In 1967 Japanese scientists Doi, Teranaka, Yora and Asuyama surprised the plant pathologists stated that Mulberry dwarf, Potato witches broom, Aster yellows or Paulownia witches broom which were

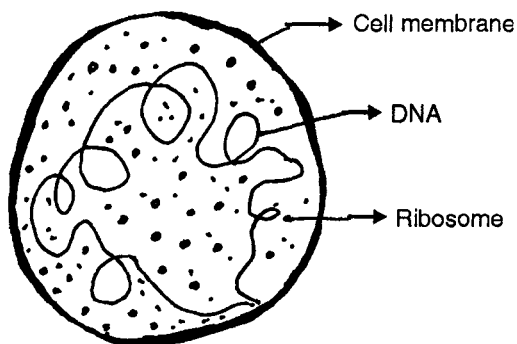

Fig. 1 : Diagrammatic representation of single cell of Mycoplasma

suspected to be the virus diseases, were in fact caused by Mycoplasma. In 1976 as many as 150 plant species were known in which Mycoplasmas could be detected.

TABLE 1
Characters of Mycoplasmas and Viruses

Properties	Virus	Mycoplasma
1. Growth on culture medium	-	+
2. Cell wall/cell wall Peptidoglycan lack	+	+
3. Generate metabolic energy	-	+
4. Depends on host cell nucleic acid for multiplication	+	-
5. Can synthesize protein by own enzyme	-	+
6. Require sterols	-	+
7. Visible in optical microscope x 1500	-	+
8. Filterable through 450 nm filters	+	+
9. Contains both RNA and DNA	-	+
10. Growth inhibited by antibody alone	-	+
11. Growth inhibited by antibiotics	-	+
12. Action on protein synthesis + positive action, negative action	-	+

GENERAL CHARACTERISTICS OF MYCOPLASMA

(1) They are very small, non-motile (except *Spiroplasma*) and prokaryotic which may be parasitic or saprophytic.

(2) They lack cell wall and the outer boundary of the cells being the cytoplasmic membrane which is three layered unit membrane structure.

(3) Their cells possess plasticity (pleomorphic) and can assume various shapes ranging from spheres to branched filaments.

(4) The plasticity allows the cells to pass through bacteriological filters even though the smallest cells are about 0.3 nm in diameter.

(5) They require sterols for their growth. They are sensitive to supersonic vibrations desiccations and most of the physical environment factors.

(6) The colony of mycoplasma on solid agar medium appears as just like fried egg under stereomicroscope. The colony shows spherical or hemispherical portion in the centre, which is surrounded by surface growth towards periphery. The typical colony is biphasic with a fried egg appearance (characterized by opaque, granular central area with a translucent peripheral zone).

(7) They are susceptible to lysis by osmotic shocks caused by sudden dilution of the medium with water.

(8) They can be cultivated *in vitro* on non-living media of rich composition as facultative anaerobes or obligate anaerobes.

(9) The genome size of mycoplasmas are about $\frac{1}{5}$ to $\frac{1}{2}$ the size of those of bacteria.

(10) Genetic material is naked circular chromosome of fibrillar (double stranded) DNA, about 3 nm thick with a molecular weight ranges from 44×10 to 1200×10 daltons. Guanine : cytosine ratio of DNA ranges from 24-10%.

(11) The mode of multiplication is presumed to be by budding or binary fission.

(12) Chemically they are much closer to bacteria because they possess 4% DNA and 8% RNA, 70s ribosomes are present in the cytoplasm.

(13) Cells are non-motile but gliding motility has been observed in a few species.

(14) Mesosomes are not found in the cells of mycoplasma, but plasmids are found on the basis of dry matter 50-80% proteins, 8-17% RNA and 4-7% DNA is present.

(15) They do not show response towards Gram staining i.e. they are Gram negative in nature. Stevens & Fox (1979) suggested a rapid and simple technique called Dien's stain for staining technique.

(16) They are insensitive to penicillin, vancomycin and cephaloridine (which effect on cell wall) but are sensitive toward tetracycline & chloremphenicol (which effect on metabolic activities) and they have harmful effect on them.

CLASSIFICATION

In 1966, International Committee of Nomenclature of Bacteria, separated mycoplasma from bacteria and placed them in class-Mollicutes. (Mollis = flexible, + cutis = stain). Edward & Friendt (1970) have classified *Mycoplasma* or PPLO under different groups on the basis of sterol requirement.

Class - Mollicutes

Order - Mycoplasmatales

Family - includes 3 families

(i) Mycoplasmataceae - e.g. *Mycoplasma*

(ii) Acholeplasmataceae - e.g. *Acholeplasma*

(iii) Spiroplasmataceae - e.g. *Spiroplasma*

CELL STRUCTURE

The ultra structure of cell of *Mycoplasma* appears as prokaryotic unicellular microorganism. The outer most boundary of cell is a unit plasma membrane which is three layered made up of lipoprotein. The chemical nature of lipoprotein consist of phospholipids and cholesterol. This unit membrane is $80-100\text{\AA}$ in thickness and selectively permeable. The membrane surrounds the cytoplasm which is packed with 70s ribosomes, R.N.A., naked circular chromosome of fibrillar double stranded DNA of about 3 nm thick, one or more electron dense areas and some empty vacuoles.

On the basis of dry weight the chemical composition of *Mycoplasma* is as follows:-

Protein - 50-80%

Lipid - approx 40%

RNA - 8-15%

DNA - 4-6%

Mesosomes are not found in the cells of *Mycoplasma* but plasmids are found 40 different types of enzymes are found in cytoplasm.

Because the *Mycoplasma* are able to pass through many filters and grow in media which do not contain living tissue. They are therefore considered to be microorganism intermediate between bacteria and viruses chemically they are much closer to bacteria. Because of their special cell structure and physiology various scientist has named *Mycoplasmas* with different nomenclature viz. Joker of microbiology, jocker of plant kingdom, Prokaryote without cell wall, and Bacteria with their coats off.

Reproduction

Morowitz and Tourtelotte (1962) reported the absence of sexual and asexual reproduction in *Mycoplasma*, but they reproduce by (i) Fragmentation (ii) Budding (iii) Young elementary bodies

Formation of elementary body is an important mode of reproduction in *Mycoplasma*. The cells of *Mycoplasma laidlawii* show unequal division at the time of multiplication, as a result of which elementary bodies of 330-450 μm size are formed. They are very minute and can live freely. They are known as primary bodies. These primary bodies increases in size and shape accordingly called as secondary and tertiary structures. Inside these larger bodies the elementary bodies are formed and this stage is known as quarternary structure and after the rupturing of larger bodies these are released and this quarternary structure develops into complete mycoplasma cell.

ECONOMIC IMPORTANCE OF MYCOPLASMA

Mycoplasma causes many diseases in plants animals and human beings. The important ones, caused in plants are as follows:

Mycoplasmal Plant Diseases :

- Little leaf disease of Brinjal.
- Bunchy top of Papaya.
- Witches broom of Legumes.
- Yellow dwarf of Tobacco.
- Sandal spike disease.
- Sesamum Phyllody.
- Stripe disease of Sugarcane.
- Witches broom of Potato.

- Clover virescence.
- Clover phyllody disease.
- Cotton virescence.

Symptoms of Mycoplasmal Plant Diseases

- (i) Plant associated with mycoplasma are infected in the sieve tubes of the plants causes upsetting the hormonal balance resulting in witches broom growth (all the axillary buds grows and convert into bunch).
- (ii) In some cases flower leaf assume the shape of foliage leaves (phyllody) and various intermediate stage between flowers and leafy sprouts can be found (antholysis). In many cases no anthocyanin are formed in petal.
- (iii) Degenerative processes in the sieve tubes of infected plant causes plant stunting, wilting or leaf yellowing and reduction of leaf size.
- (iv) Colour breaking in the calyx portion of infected flower causes greening of all flower parts (virescence) and transferred into green leaf like structure (Phyllody).
- (v) Stem become flat in infected plant.
- (vi) Excessive callose formation and cell necrosis occurs in the sieve tubes of infected plant which can be visible under a fluorescence microscope after staining with aniline blue (serves as indirect indication for the presence of mycoplasma).

Transmission of Disease

- (i) Plant mycoplasmas are known to be transmitted by certain insect vectors (leaf hopper) of cicadellidae and psyllidae. Once mycoplasma invade the insects salivary glands the vectors can transmit these organisms with the help of their saliva to healthy plants.
- (ii) By grafting, mycoplasma can be transferred to healthy plant.
- (iii) With the aid of *Cuscuta*, mycoplasma can be transferred from diseased to healthy plants. (with the help of haustoria) but this type of transmission does not occur in nature.
- (iv) An aphid named *Acrythosiphon pisum* transmit mycoplasma in *Pisum sativum*.

Mycoplasmal Human Diseases

- (i) *Mycoplasma pneumoniae* causes the disease primary atypical pneumonia (PAP) in the mouth, pharynx and genitourinary tract.
- (ii) *Ureaplasma urealyticum* have been found in women experiencing repeated or habitual reproduction failure.
- (iii) Two species of mycoplasma viz. *M. hominis* and *M. fermentans* has been found responsible for infertility in men.
- (iv) *M. orale* and *M. salivarium* are found responsible for respiratory tract infection.
- (v) Mycoplasma have also been found in cases of arthritis and inflammation of the middle ear.

Mycoplasmal Animal Diseases:

- (i) Inflammation of genitals in animals is caused by *Mycoplasma bovigenitalium*.
- (ii) Bovine pleuropneumonia in animals is caused by *Mycoplasma mycoides*.
- (iii) Agalactia of sheep and goat is caused by *Mycoplasma agalactiae*.
- (iv) Sinubitis in hen is caused by *Mycoplasma melegridis*.

Thermoplasmas are heat loving mycoplasma. The optimum temperature for growth is 59°C. They are Gram variable.

The genus *Thermoplasma* grows at a temperature of 55-59°C (max. 62°C) and pH 2 (minimum 1 to max. 4). The genus is distinct from other extreme thermophiles as it resembles the eubacterial genus *Mycoplasma* in lacking a cell wall and forming fried egg colony. It grows in refuse piles of coal mines which contain iron pyrites (FeS) which oxidized to sulphuric acid by lithotrophs. *Thermoplasma* lacks a cell wall but cell membrane contains large amounts of lipopolysaccharide and glycoprotein (diglycerol tetraethers). The DNA is stabilized with a histone like protein, thus resembling the chromosome of eukaryote.

Spiroplasma are spiral form mycoplasmas. The helical filamentous forms are motile and show rapid rotary or screw motion and slow undulation motion. They are gram positive.

Mycoplasma resembles L-form in (i) having similar ultrastructure (ii) soft pleomorphic cells devoid of mucopeptide wall (iii) not osmotically fragile (iv) growth on media without osmotic protection. They differ from L-forms in the following characters : (i) while the L-forms revert to normal cells when the antibiotic is removed, mycoplasma never synthesizes the wall and (ii) while L-forms are non-pathogenic, mycoplasmas are important pathogens.

L- form was isolated by Kleinberger Nobel in 1935. The cells were called L- forms after Lister Institute in London where they were isolated. L-forms are spheroplast like structure lacking cell wall. These naked protoplast can also be isolated from *Salmonella*, *E. coli* and *Proteus* (both Gram positive and Gram negative) as well as from other bacteria by cultivation on serum agar with penicillin (100 µg/ml) in laboratory conditions. They produce fried egg type colonies which resemble those of mycoplasma species. Two types of L-forms have been isolated.

The L-form colonies can be lifted and cultured at higher concentration of penicillin as at lower concentrations the L-forms revert to normal bacterial cells with walls. L forms resemble protoplasts and sphaeroplasts in (a) lack of flagella. (b) inability to sporulate (c) lack of some or all cell wall antigens (d) reversion to normal cells when antibiotic treatment is stopped.

The L-forms do not multiply by binary fission. They increase in size (upto 50µ) and than form large number of small (0.1-0.3µ) units called elementary corpuscles by fission or budding.

These similarities suggest that in nature, mycoplasma might have originated from L-forms by loss of the capacity of reversion to normal cells. Thus L-forms are closest to mycoplasma, could be thought of as their progenitor.

PHYTOPLASMA

Phytoplasmas were earlier known as mycoplasma like organisms (MLOs) because of their similarities with mycoplasmas when observed under electron microscope. These are plant parasitic prokaryotes that lack a cell wall and occur in phloem elements of the shoots. The most common symptoms of affected plants are yellowing, phyllody and witches' broom. In India, these have been reported on citrus and coconut plants.

MOLLICUTES

Presence of cell wall is the fundamental characteristic of bacteria, absence of wall in certain prokaryotic organisms incited some workers to work out their systematic position. Nocard and their collaborators first cultured a wall less contagious microbe, causing pleuropneumonia of cattle, on artificial broth in 1898. They observed small colonies with dark center and light peripheral area that resembled with fried eggs. Like viruses, these microbes were filterable. Cell wall free and filterable prokaryotes discovered until 1930s were named as "Pleuro-Pneumonia like Organisms" or "PPLOs".

In 1960s, these wall-less prokaryotes were given the collective term "Mycoplasmas" (Greek noun *mycos* meaning fungus and the Greek noun *plasma* meaning something formed or moulded) since it was proposed that all such similar organisms be assigned to the genus *Mycoplasma*. This terminology became obsolete when new microorganisms such as *Acholeplasma* and *Ureaplasma*, etc., were being isolated and characterized. Therefore, a revised classification scheme was devised whereby all filterable, wall-less prokaryotes were covered under a broad system called the class-Mollicutes (from the Latin adjective *mollis* meaning pliable and the latin noun *cutis* meaning skin).

Mollicutes are the smallest biologically self-replicating cells with their diameter between 0.30 μm and 0.80 μm . Out of all living organisms, the Mollicutes have smallest reported genomes. The size of their genome is as small as 400 MDa. Mollicutes have

evolved specifically from a branch of the phylogenetic tree containing Gram positive bacteria with an unusually low (23-46%) G + C ratio. Although they are equipped with DNA and RNA for performing protein synthesis, but their limited biosynthetic capabilities create a huge dependence on their environment. The pleomorphic characteristics of Mollicutes range from coccoid to filamentous form, but often demonstrate the characteristic "Y" shape appearance. They are able to pass through 0.45 μm and 0.22 μm filters commonly used in biological sterilization. Mycoplasma was the common term for all cell wall less organisms belonging to the Class-Mollicutes. This class encompasses eight genera, *Spiroplasma*, *Ureaplasma*, *Mycoplasma*, *Acholeplasma*, *Anaeroplasmia*, *Asteroplasmia*, *Entomoplasmia* and *Mesoplasmia*.

PHYTOPLASMAS

Many yellowing diseases of plants were thought to be caused by viruses because of the symptoms and mode of transmission and reproduction of the causative organisms. Doi *et al* proposed that some yellowing disease could be the result of cell wall less prokaryotes instead of viruses. This idea led to the discovery of pleomorphic, wall free prokaryotic endoparasites residing in the phloem of diseased plants. Cell wall free prokaryotes infecting plants were previously termed as "Mycoplasma like Organisms" or "MLOs", because of their structural resemblance to mycoplasma. Mycoplasmas cause various kinds of disorders in humans and animals and are sensitive to tetracycline and penicillin both, whereas MLOs are sensitive to tetracycline only. In contrast to mycoplasma, the plant parasitic MLOs cannot be cultured *in vitro* in cell free media. In the last decade evidences provided by fluorescence and electron microscopy and application of molecular techniques resolved that MLOs are the mollicutes quite distinct from mycoplasmas. This finding led to a proposal that the term MLOs be replaced with the generic name of PHYTOPLASMA.

Phytoplasmas are the smallest known phloem-limited plant pathogenic unicellular obligate endoparasites. These are bacteria-like prokaryotic organism surrounded by plasma membrane that lack true nucleus and membrane bound organelles. Their mode of multiplication is through binary fission. Phytoplasmas have no characteristic cell wall and have neither been isolated, nor purified, nor cultured on an axenic medium so far. These are pleomorphic that can stretch and can cross the sieve plates to migrate towards the roots in autumn and towards the shoot in spring.

Phytoplasmas are thought to be evolved from the Gram positive bacteria, they have a DNA genome which is A-T rich, some Phytoplasmas have the lowest G-C content (23 to 26.3%) of any living organism. The size of genome of these microbes ranges from 640 to 1185 kb. Phytoplasmas have a long incubation period that can spread as epidemic causing significant economic damage. Symptoms on infected plants become evident only one or two years after infection, when the disease has already spread to other plants. Phytoplasmas are considered to be quarantine organisms in the European Union. Transportation of Phytoplasma infected plants is forbidden even if the specific vector species is absent in the importation area.

Occurrence and Maintenance

Like mycoplasma, phytoplasmas are organ/tissue specific. They are found more frequently in the roots, but can also be found in many places in the plant. Phytoplasmas are obligate endoparasites located inside the cell walls of their hosts, either as extra-cytoplasmic in mature sieve tubes or as intra-cytoplasmic in young sieve tubes. Since leaf hoppers and plant hoppers are their vectors, therefore, these have been discovered in their body parts also. Phytoplasmas have not yet been grown *in vitro* on cell free nutrient media in the laboratories. All efforts to culture these microorganisms under artificial conditions have been failed. Phytoplasmas are maintained in the host plants. This can be achieved by tissue culture techniques, by grafting infected twigs on susceptible plants, or by insect transmission.

Detection

Unlike typical bacteria, phytoplasmas cannot be cultured on artificial media in the laboratory. However, they can be determined with phytoplasma-specific stains such as DAPI (4, 6- diamidino-2-phenylindole) a nucleic acid stain, which stain bacteria in phloem. Dienes' stain is metabolized by phytoplasmas that produces blue colour. Healthy phloem does not impart colour. Dienes' stain is more specific than DAPI. Phytoplasmas are detected by grafting infected twigs to susceptible host plants such as Periwinkle (*Catharanthus roseus*). These can also be detected using light or electron microscopy, molecular techniques including DNA probes, enzyme linked immuno-sorbent assays (ELISA) and DNA amplification using the polymerase chain reaction (PCR).

Vectors

Phytoplasma vector species belong to hemipters that are phloem-feeding insects. Three families (Jassidea, Cixidae and Psyllidae) contain the known vector species. It has been found that phytoplasmas circulate, multiply and persist in the body of leafhopper vectors. It is considered that phytoplasmas are not transmitted vertically to the progeny of infected specimen. Among plant hoppers, species in the cixiid family are known to transmit phytoplasma belonging to "stolbur" group. Among psyllids, several species have been shown to transmit diseases of fruit trees. Leafhoppers, and psyllids are the most common vectors of phytoplasma.

Spread and Transmission

Phytoplasmas are completely dependent on their host for existence, as these are obligate endoparasites. They live in phloem of the plants. Phytoplasmas generally move to a new area by grafting, planting infected cuttings, by parasitic plants such as Dodder (*Cuscuta Spp*) and by leafhoppers, which migrate annually. Phytoplasmas are phloem-limited and cannot be transmitted through seeds. It is unlikely that phytoplasmas could survive the desiccation usually associated with seed formation.

Disease Symptoms

Symptoms on plants include virescence (the development of green flowers), phyllody

(the development of floral parts into leafy structures), sterility of flowers, proliferation of adventitious or axillary shoots resulting in witches-broom appearance, abnormal elongation of internodes resulting in slender shoots, generalized stunting (eg. small flowers, leaves, shortened internodes), unseasonal discoloration of leaves or shoots (eg. yellowing, purple discoloration), leaf curling or cupping, bunched appearance of growth at the ends of stem, brownish discoloration of phloem tissues, and generalized decline (stunting, die back of twigs of trunks, lethal yellowing).

Diseases associated with the presence of phytoplasmas in phloem typically exhibit an array of symptoms mentioned above.

Identification

(1) Enzyme linked immunosorbent assay (ELISA), using polyclonal and monoclonal antisera;

(2) Dot hybridization assay, using cloned phytoplasma DNA and their complementary RNA probes;

(3) Southern hybridization assay, by analyzing RELP of part of or total genomic DNA using selected cloned DNA probes, including highly repetitive sequences in the genome;

(4) Polymerase chain reactions (PCR), using primers based on cloned DNA fragments specific to a given phytoplasma or a subgroup and

(5) RELP analysis of DNA sequences with various degrees of conservation, using various conserved sequences such as 16s rRNA gene, ribosomal protein, operon, tuf gene and other chromosomal DNA fragments.

Classification

Phytoplasma diseases were initially classified either on the basis of the symptoms (decline, proliferation and virescence) they develop, or type of plants infected by them, or type of insect vectors (leafhoppers, plant hoppers and psyllids) that transmitted them to the plants. In the previous decade, identification of phytoplasma has been resolved through novel techniques of restriction endonuclease digestion of PCR-amplified rDNA products, electrophoresis of digests on agarose or polyacrylamide gel, and comparison of resulting fragments with those of known phytoplasmas. In 1993, Lee *et al* identified a total of 16 groups of 16SrDNA on the basis of dissimilarities of restriction sites detected by rDNA RELPs.

Garrity *et al* divided the domain bacteria into 23 phyla of which 13th phylum Firmicutes comprises of three classes (namely Clostridia, Mollicutes and Bacilli). The class-Mollicutes, consists of wall less bacteria and has been divided into five orders: the order Acholeplasmatales has a single family Acholeplasmataceae that comprises only two genera-*Acholeplasma* and *Phytoplasma*.

Domain: Bacteria (23 phyla)

Phylum: Firmicutes (3 classes)

Class: Mollicutes (4 orders)

Order: Acholeplasmatales (1 family)

Family: Acholeplasmataceae (2 genera)

Genus: Phytoplasma

Phytoplasma 16SrI	Aster yellows group
Phytoplasma 16SrII	Peanut WB group
Phytoplasma 16SrIII	X-disease group
Phytoplasma 16SrIV	Coconut lethal yellows group
Phytoplasma 16SrV	Elm yellow group
Phytoplasma 16SrVI	Clover proliferation group
Phytoplasma 16SrVII	Ash yellows group
Phytoplasma 16SrVIII	Loofah witch's-broom group
Phytoplasma 16SrIX	Pigeon pea witch's-broom group
Phytoplasma 16SrX	Apple proliferation group
Phytoplasma 16SrXI	Rice yellow dwarf group
Phytoplasma 16SrXII	Stolbur group
Phytoplasma 16SrXIII	Mexican Periwinkle virescence group
Phytoplasma 16SrXIV	Bermuda white leaf group
Phytoplasma 16SrXV	Hibiscus witch's broom group

Seemuller *et al* (1998) described eight more genera which are given below and were not mentioned in the previous classification AUSGY-Australian Grapevine Yellows, IBS-Italian pineweed stolbur, BWB- Buckthorn witches' broom, SpaWB-Spartium witches' broom, IAWB-Italian alfalfa witches broom. CirP-Circium phyllody, BGWL-Bermuda grass white leaf and Tanzania lethal decline.

CURE AND MANAGEMENT

Many plants can be cured of phytoplasmas with heat treatments and/or by passing them through tissue culture. Phytoplasma infected plants are passed through seed cycle, since Phytoplasmas are not seed transmitted. Remission of symptoms and curing a plant can be achieved through the application of the antibiotic tetracycline.

Conventional control methods include sanitary selection, in some cases pruning of branches of woody plants with localized symptoms, destruction of phytoplasma reservoir plants, monitoring of vector species, thermotherapy, cross protection and genetic selection for tolerant of resistant varieties.

Little Leaf of Brinjal or Egg Plant

Little leaf of brinjal (*Solanum melongena*) is found throughout India and other neighbouring countries. This disease was first reported from Coimbatore by Thomas and

Krishnaswami (1939). Almost all brinjal varieties are susceptible to this disease. The disease is a serious threat for the crop grown. When young plants are attacked they do not produce flowers and fruits. The disease can cause upto 64% reduction in plant productivity. The mycoplasma can affect at least 13 plants genera in 5 families include cultivated and wild egg plants, datura, tomato, tobacco etc.

Symptoms

The main symptom is production of very short and small leaves. The petioles are so much reduced in size become narrow, soft, smooth and yellowish in colour. Newly formed leaves are further reduced in size. The inter node become shortened and at the same time large number of axillary buds are stimulated to grow into short branches with small leaves. This gives the plant a bushy appearance and plant fail to form flowers and even if flowers are formed they remain green and leaf like. Virescent (a coloured tissue that develops chloroplast and becomes green), and phylloid flowers (floral coloured parts develop chloroplast and become green) is common fruit setting is seldom.

Verma et al. (1969) showed that the disease symptoms are associated with MLO's (now phytoplasma). MLB's were described as spherical to ovoid structure (40-300 nm) and were present in the phloem cells of diseased plants. The phytoplasma are also seen in the body organs of vectors.

In nature the causal agent of the disease is transmitted by the leaf hopper vector *Cestius phycitis* and also by *Empoasca devastans*. Vector acquire MLO's after several days of feeding and transmit MLO's after an incubation period of 10-45 days. The incubation period is required for the multiplication and distribution of MLO's in the insect body. During the off season of brinjal crop the causal agent survives on weed hosts (*Solanum xanthocarpum*) and then it is transmitted to the main crop by the insect vectors. Bitter gourd, water melon, carrot, sunhemp are good hosts of the vector and beet, castor, soybean are suitable for oviposition.

Control

No effective control measures against the pathogen is known. Antibiotic treatment with tetracycline is reported to control the disease eradication of weed hosts and diseased brinjal plants and control of insect vectors by insecticide is the only recommendations in India. The Indian variety Brinjal round is tolerant.

GENERAL ACCOUNT OF CYANOBACTERIA

The two divisions of algae contain prokaryotic algae which are now usually called bacteria in view of their cell structure being very similar to eubacteria. Thus cyanophyta (= Cyanophyceae) are called cyanobacteria and Prochlorophyta (= Prochlorophyceae) are termed Prochlorobacteria.

The Division - Cyanophyta (Cyanobacteria) are the blue greens, the most primitive of algal organisms. They have existed on the surface of the earth since the early Precambrian. Blue green algae are kept under the class myxophyceae or cyanophyceae of the algae division. They are commonly called as blue-green algae due to the presence of water soluble accessory photosynthetic pigments named C-phycoerythrin and C-phycoerythrin which impart blue-green colour to the algae. Along with this certain characteristics Xanthophylls viz myxoxanthin, and myxoxanthophyll, oscillaxanthin, zeaxanthin are present in addition to chlorophyll -a and β - carotene etc. Fritsch (1945) classified the blue green algae into class myxophyceae. He also called this algae as the members of class schizophyceae (Schizo = fission) and phycochromophyceae. An eminent Indian phycologist Prof. T.V. Desikachari (1959), Morris (1973) and Round (1973) kept this algae in Division Cyanophyta but Chapman (1962) gave them a separate name Myxophycophyta. But according to recent trend these members are kept under the members of prokaryota and called as cyanobacteria.

GENERAL CHARACTERS OF CYANOBACTERIA

- (1) They have a prokaryotic cell organisation.
- (2) They lack the membrane bound cell organelles such as chloroplast, mitochondria, E.R., nucleus. They lack definite chromosome however DNA fibrils are present.
- (3) Photosynthetic pigments include chlorophyll- a, β - carotene, xanthophylls

(lutein and zeaxanthin) and biliproteins (C-phycoyanin and phycoerythrin). No distinct plastid, the photosynthetic pigments are located on photosynthetic lamellae (thylakoid) generally scattered in the peripheral protoplast.

- (4) Thallus bears a specialized gliding movement.
- (5) Reserve food material is cyanophycean starch and cyanophycean granules.
- (6) According to Fischer (1897) the cytoplasm of cell is divided into two parts the outer or peripheral chromoplasm and the central colourless centroplasm.
- (7) Many members of class cyanophyta are involved in nitrogen fixation viz. *Nostoc*, *Anabaena*, *Calothrix* and *Cylindrospermum*.
- (8) All the members of this class secrete mucilage and usually possess a mucilage sheath. This mucilage may be yellow, brown, red or purple in colour.
- (9) Many floating and planktonic algae member of this class bears gas vacuole. For example in *Nostoc*, *Calothrix*, *Phormidium* etc. The gas vacuole provide buoyancy to the floating algae.
- (10) Vegetative reproduction is by means of hormogonia, endospore, and nanocytes like structure.
- (11) No asexual reproduction is reported.
- (12) No sexual reproduction. However genetic recombination has been observed in few species eg. *Anacystis nidulans*.
- (13) No motile cells (even the reproductive cells are non motile) and lack flagella.

OCCURRENCE

Blue-green algae are found in all parts of the world from the tropics to the polar regions, and from the oceans to the top of the mountains. Majority of genera are found both in fresh as well as in brackish (saltish) water.

High temperature, intense light and humid environment is required for the growth of thallus. According to Desikachari (1959) about 160 genera and 1500 species are reported from the tropical areas. In India the members are represented by 85 genera and 750 species. The members of blue green algae are found in hot and humid environment, moist or alkaline land, along with this they require high intensity of light. The members of blue green algae grow extensively in the paddy fields of tropical and temperate climate region eg-*Anabaena*, *Nostoc*, *Tolypothrix*, and *Cylindrospermum* grow actively and fix atmospheric nitrogen.

Some members of cyanobacteria are found in fresh water lakes, ponds and various types of water reservoirs. Many members grow extensively on the surface of fresh water and form water blooms. eg-*Microcystis* and *Arthospira*. Such algae growth emit bad odour and render water obnoxious and undrinkable.

Some blue green algae when abundant, may also impart their colour to water. For eg. *Trichodesmium erythraeum* is responsible for red colour of the red sea. The red colour is due to the presence of red pigments in the cell, and the extensive growth of this algae impart the expression of red coloured water of the sea.

Some blue green algae live symbiotically with different organisms, ex- *Anabaena* and *Nostoc* in *Anthoceros* (Bryophyta) thallus and *Anabaena* in *Cycas* (corolloid) root. Some members live with fungi forming lichens. A few blue green algae eg. *Oscillospira* and *Anabaenium* live endozoically (growing inside animals) in the digestive tract of mammals, including man, while some others live in unicellular animals.

Members of cyanophyceae are pioneer colonizers (first inhabitant) of bare rocks and virgin lands. They also grow on alkaline or saline soils.

Following are the examples of blue green algae found in various habitat:

1. Fresh water ponds and lakes - *Anabaena*, *Oscillatoria*, *Rivularia*, and *Cytonea*.
2. In sea water - *Trichodesmium* and *Dermocarpus*.
3. In moist land - *Anabaena*, *Nostoc*.
4. Hot water springs - *Phormidium* and *Microcystis*.
5. As an endophyte - *Gleocapsa* and *Anabaena*.
6. In the intestine of man - *Semoncela* and *Oscillatoria*.
7. Limestone rocks - *Gleocapsa salina* and *Calothrix peritina*.
8. Lichen- *Gleocapsa*, *Nostoc*, *Scytonema*, *Stigonema*.
9. Hot water springs (temp. 70-75°C) *Mastigocladus* and *Phormidium*.

THALLUS ORGANIZATION

The thallus ranges from unicellular to coenobial and filamentous forms. Filamentous forms may be unbranched or branched, heterotrichous or even pseudoparenchymatous. Architecturally the thallus may be a solitary cell or a colony.

(1) **Unicellular:** The thallus is a unicell which may be spherical or oval eg- *Chroococcus*, *Synechococcus* and *Gleocapsa*. Actual unicellular forms however are not many because the copious secretion of mucilage by the daughter cells results in the daughter cells, remaining together after division.

(2) **Colonial forms:** In cyanobacteria the cells after division remain attached by their walls or are held in a common gelatinous matrix to form a loose organisation of cells which is termed as a colony. The colony is of two types:

(a) **Palmelloid:** The thallus structure resembles the algae *Palmella* eg- *Microcystis* and *Gleocapsa*.

(b) **Dendroid:** The thallus is found in *Chamaesiphon*.

(3) **Filamentous:** The cells are arranged end to end in a row which is a result of repeated cell divisions in a single plane and in a single direction forming a chain or a thread. It is known as the trichome. The trichome together with its mucilaginous sheath is called a filament. In most cases a single filament has a single trichome, but in some cases more than one trichome may occur within the common sheath. The cells of trichome may show little or no differentiation into base and apex ex. : *Oscillatoria* or it may have a broad base while its apex tapers to a hair like structure. Ex- *Rivularia*.

The trichomes of some members are 'homocystous' i.e. made up of uniform cells e.g. *Oscillatoria* but trichomes of majority of algae are 'heterocystous' i.e. it contain some special cells called 'heterocyst' at one or both ends or at regular intervals along their length eg. *Rivularia*.

Trichomes may be branched or unbranched:

(a) **Unbranched:** Trichomes are unbranched (simple) in some members (e.g. *Anabaena*, *Nostoc*, *Oscillatoria*) simple trichomes may be either free floating (e.g. *Spirulina*) or aggregated into colonies (eg. *Anabaena* and *Nostoc*). Some time unbranched trichomes show false branching (eg. *Scytonema*). A cell of a trichome dies and one or both ends of the trichome at the point of the dead cell grow out as false branches.

(b) **Branched :** Trichome are of the following three types:-

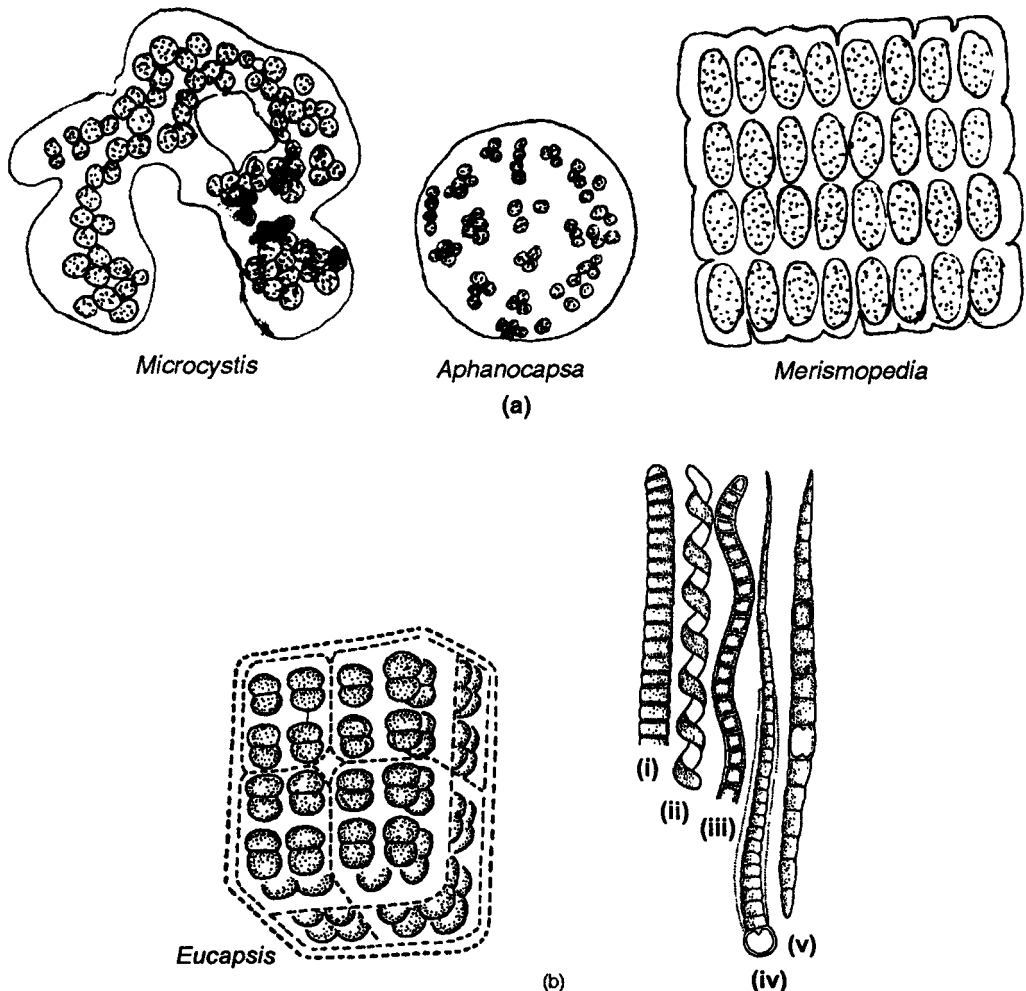

Fig. 1 : (a,b) Thallus organization in cyanobacteria (i) *Oscillatoria* (ii) *Spirulina* (iii) *Arthrospira* (iv) *Rivularia* (v) *Aphanizomenon*

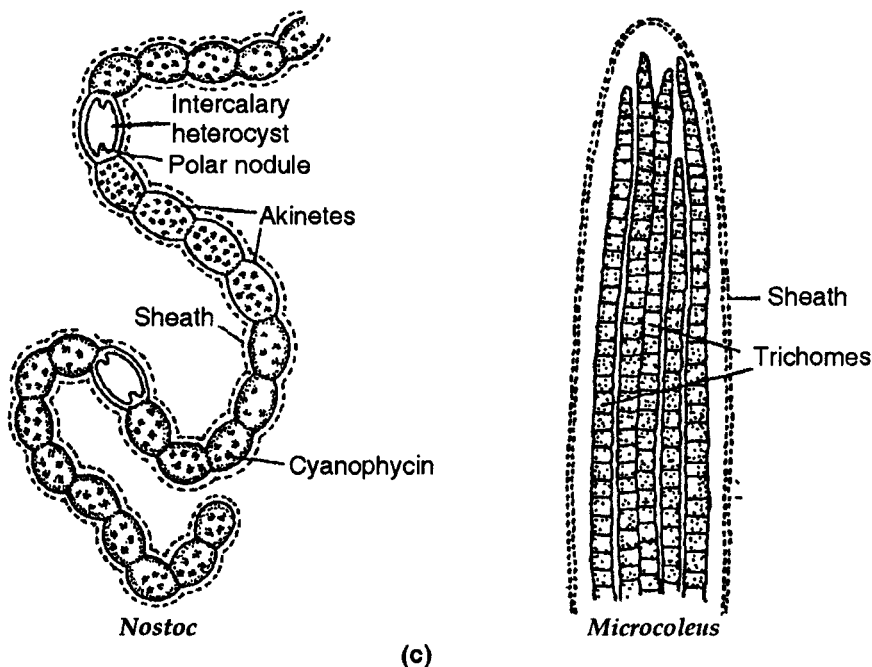

Fig. 1 : (c) Thallus organization in cyanobacteria

(i) **Simple branching** : Such trichomes occur in some members eg. *Westiella*.

(ii) **Heterotrithous** : Thallus has well developed prostrate and erect branches. eg.- *Mastigocoleus*.

(iii) **Pseudoparenchymatous** : A central row of cells is surrounded by a ring of pericentral cells which are connected to the former by pit connections. Siphonaceous and true parenchymatous forms are lacking in cyanophyta.

CELL STRUCTURE

Following structures are found in a prokaryotic cyanophyceae cell.

(1) **Sheath**: Cell in some species possess an external diffluent delicate mucilaginous sheath. The sheath is usually thick and slimy but in a few forms such as *Anacystis montana* it is extremely delicate. The secretion of copious mucilage is an important characteristics of the blue green algae and earned for them the name myxophyceae which means slime algae. Sheath serves to hold the cell colonies together. The sheath may become lamellated or stratified and sometimes pigmented. In the later case it is usually yellowish or brownish in colour. Usually it is colourless. The slimy nature of the sheath endows the cell with great water absorbing and water retaining capacity favouring its survival under conditions of dessication.

(2) **Cell wall**: Cell possess a distinct cell wall which is relatively thick and two layered i.e. outer and inner layers. The members of order stigonematales bear well developed pit connections between the cells.

Cell wall is found between the mucilaginous sheath and cell membrane. Pectin is found in the form of Calcium and Magnesium pectate. According to Carr and Whilton (1973) cell wall is a tough and complex structure and divided into four layers viz. LI, LII, LIII and LIV respectively. The outer layer bears cellulose, hemi-cellulose, muramic acid and amino acids while the inner membrane had alanine, glucosamine, glutamic acid and dipicholinic acid. The longitudinal wall of *Oscillatoria* bears pores. Some endosymbionts viz. *Cyanophora* and *Glaucocystis* lacks cell wall and contain plasma membrane made up of lipoprotein.

(3) **Protoplast:** The protoplast of cyanophyta is a less differentiated structure as it lacks an organized nucleus with distinct surrounding membrane, endoplasmic reticulum, membrane bound plastids, mitochondria, golgi apparatus, and sap vacuole. Cytoplasm undergoes no cyclosis and streaming movements. Under light microscope the cytoplasm appears to be divided into two region: a centrally located clear area surrounded by a denser portion. The former is called centroplast and the latter chromoplast. The two regions are not separated from each other by any membrane or other structure.

(i) **Chromoplast:** This is the outer pigmented zone of the cell protoplast. The structure of chromoplast is considered homogenous, finely alveolar, or reticular structure. The chromoplast contains a considerable amount of imbibed water and sticks to the wall. The osmotic pressure of the cell is low. Chromoplast contains a number of non-living inclusions in the form of small, spherical or irregularly shaped granules. Majority of them are the nature of reserve food materials which may be of proteinaceous or carbohydrate nature. The carbohydrate are stored in the form of a unique kind of starch known as cyanophycian starch. The proteinaceous granules are named the cyanophycian granules. In some species oil droplets as well as lipids occur in the chromoplast.

Some planktonic species such as *Anabaena* and *Polycystis* the chromoplast contains clusters of gas or pseudovacuoles. These are gas containing cavities within the protoplast. The walls of these vacuoles are freely permeable to the common gas. The gas filled pseudo-vacuoles make the algae thallus buoyant and thus rise to the surface of water. The pseudo vacuoles provide a buoyancy-regulating mechanism enabling the planktonic species to poise at particular depth.

The pigments under light microscope appear to be in solution in the chromoplast. The pigments are chl-a, β -carotene, xanthophylls and phycobilins. Phycobilins are blue C-phycocyanin and red C-phycoerythrin. Xanthophyll are zeaxanthin, myxoxanthophyll, myxoxanthin and scilloxanthin. The phycobilins are water soluble whereas the chlorophyll and carotenoid are fat soluble.

This accounts for the many hues in the chromoplast from dark-green to blue green, olive green, grey-green, yellow, brown, purpled orange or red in some blue green algae such as *Chroococcus turgidus*.

(ii) **Centroplast:** It forms the central area of the protoplast of a cyanophyte cells. It forms about $\frac{1}{4}$ to $\frac{1}{2}$ the volume of the cell and consist of a relatively dense mass

of material which is considered nuclear in nature. The nuclear material is arranged in a loose reticulum and includes fibrils in which DNA and RNA are present. In modern terminology genophore is the name suggested for such a primitive nucleus. The division is amitotic.

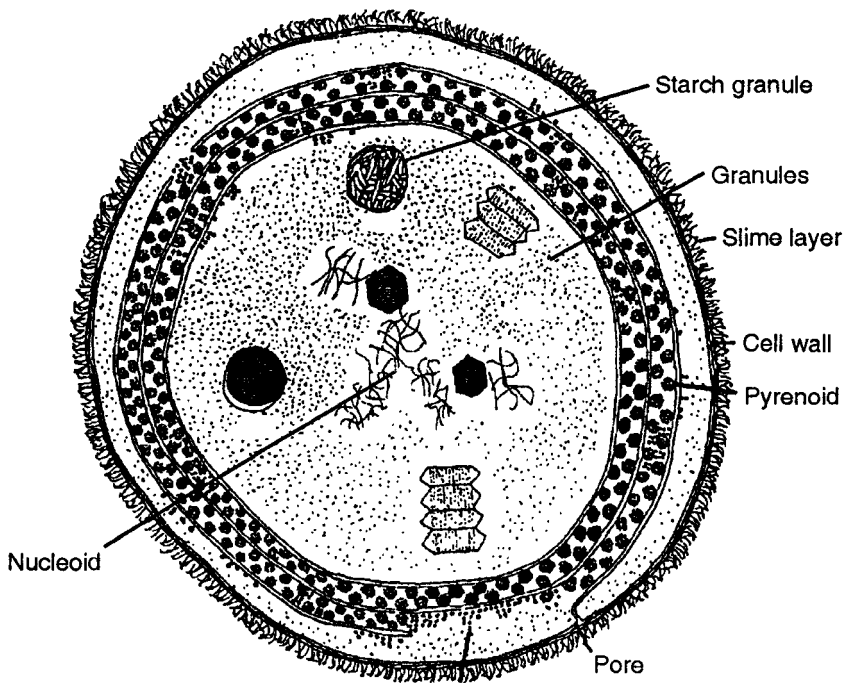

Fig. 2 : Cell structure

PHOTOSYNTHETIC PIGMENTS AND CHROMATIC ADAPTATION

Embedded in the cytoplasm within the plasma membrane are elongate flattened sacs named the lamellae or thylakoids. They are not seen under light microscope. The lamellae tend to be concentrated and organized in parallel arrays near the periphery of the protoplast. EM show that the thylakoid contain pigments and thus constitute the photosynthetic apparatus of the cyanophyte cells. Each thylakoid is bounded by two unit membranes with a small flattened area in between. The thylakoid bears the photosynthetic pigment like chl-a, β -carotene and lipid globules. Phycobilisomes particles are present on the surface of thylakoid. The particles contain the water soluble pigment C-phycoyanin and C-phycoerythrin. Bisalputra *et al.* (1969) suggest that the photosynthetic lamellae provides the sites for cellular respiration also and hence should be termed as photosynthetic respiratory membrane. These membrane can change their positions under certain conditions unlike other algae. In some blue green algae the visual colour of thallus depends upon the quality and type of light. For example in the presence of red light the thallus of *Oscillatoria* appears green in colour while in yellow light it

appears blue and green in the presence of red light. Thus this quality of thallus to change its colour according to the colour of light it receives is called as complementary chromatic adaptation or the Goidukov phenomenon called after the name of its russian discoverer, Goidukov (1902, 1906 to 1923). This chromatic adaptation helps the algae to maximum utilize the available light for photosynthesis.

(5) **Nucleoid:** It is found in the centropasm portion of the cell. The DNA fibres are spreaded irregularly in the nucleoid. The fibres lack histones and protamines. The genome is 2nm in width and 1.6×10^9 dalton in its molecular weight. According to Herdman (1974) the genome of cyanobacteria varies from 1.2×10^9 to 7.4×10^9 . It means that about 2 to 6 replicas can be made of this genome.

(6) **Other Cell Inclusion:** Irrespective of the above structures the cyanophycean cell contain other cell inclusion like cyanophycean granules, polyhedral RNA containing structure polyphosphate structures, alpha and beta particles. 70S ribosomes etc. Along with this polyglucoside granules are attached with the thylakoids. According to Lang (1972) these are combined forms of glycogen particles and polyphosphate structures along with this gas vacuoles or pseudovacuaules are also found.

(I) Gas Vacuoles or Pseudovacuaules

Recent observations have shown that the gas vacuoles or pseudo-vacuoles common in planktonic *Oscillatoria* and *Anabaena* species are of irregular shape and consist of cylindrical vesicles with conical ends stacked in arrays. These vesicles are bound by single membrane. The membrane is permeable to common gases. Fogg (1972) has shown that the gas-vacuoles are more commonly produced under low intensity of light and then suddenly collapse under high intensity of light. This results due to increased rate of photosynthesis which produces more quantity of sugar and increases the osmotic pressure so that there is a quick collapse of the gas-vacuoles at the surface level of water in the planktonic species. After collapse the filaments sink down at the bottom of water-reservoir. Thus gas vacuoles have a great ecological importance and serve to regulate the buoyancy of the planktonic forms. According to Pringsheim (1966) the gas vacuoles are produced under anaerobic conditions in *Oscillatoria agardhii*.

(II) Heterocyst

Certain members of the genera Nostocales and Stigonematales (which include filamentous forms) except Oscillatoriales produce enlarged, thick walled, pale yellowish specialized cells in addition to the vegetative

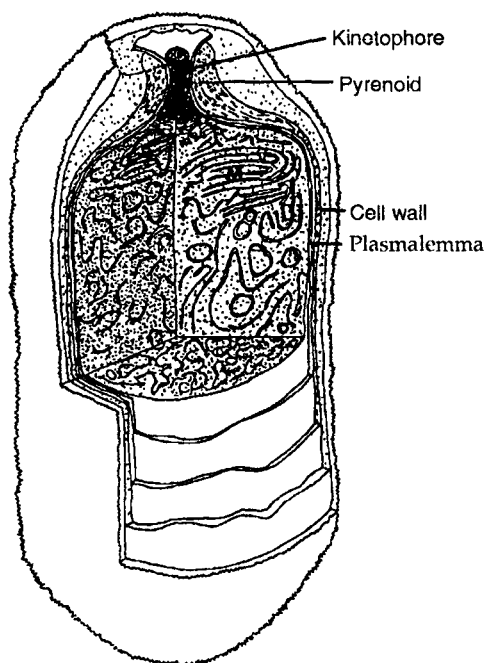

Fig. 3 : Ultrastructure of heterocyst

cells. These large empty looking specialized cells are called the heterocysts. The heterocysts are peculiar in blue green algae. They may be terminal or intercalary in position in filamentous algae.

The heterocyst develops from an ordinary vegetative cell particularly the recently divided one usually one of the daughter cell called the proheterocyst develops into a heterocyst and the other into a vegetative cell. The contents become uniform and pale in colour. The end walls become rounded. The other changes takes places are :

- (i) Secretion of an inner non cellulose polysaccharide wall layer external to the original cell membrane.
- (ii) Formation of pore either at one or both poles of the new wall layer.
- (iii) Establishment of protoplasmic connections with the neighbouring vegetative cells through the polar pores.
- (iv) Filling of polar pores towards maturity by mucilage which looks like shining nodules under the microscope.
- (v) The cell contents become homogenous with chemical changes in the nucleic acids.
- (vi) Gradual loss of photosynthetic pigments except carotenoids.
- (vii) Recent studies using electron microscope reveal that the process of transformation of a vegetative cell into a heterocyst involves gradual enlargement of the entire cell and cell wall becomes many layered. The photosynthetic lamellae become reoriented and form a complex reticulation.

PHYSIOLOGY AND NATURE OF HETEROCYST

- (i) Fritsch (1951) called the heterocyst of cyanophyta as 'a botanical enigma'.
- (ii) According to Geitler *et al* "the heterocyst are archaic reproductive cells, now largely functionless but at time still fulfilling their old role.
- (iii) Wolk (1966) & Fay *et al* (1968) says heterocyst play a role in sporulation. This found support from the fact that the vegetative cell near the heterocyst sporulate earlier and that heterocyst is removed, there is no sporulation in *Anabaena cycadeae*.
- (iv) During 1969 evidence suggested that the heterocyst provide the site for the fixation of atmospheric nitrogen since the enzyme nitrogenase essential in the process of nitrogen fixation is found to be present only in heterocysts and not in vegetative cell.
- (v) Stewart (1972) believe that all nitrogen fixing blue green algae are heterocystous.

All these condition sufficiently prove that the heterocyst are solely meant for the fixation of elementary nitrogen.

According to Fogg following factors control the production of heterocyst:

- (i) Heterocyst formation increases under conditions of low light intensities. Blue green light inhibit while red light promote heterocyst formation.

- (ii) The increase in the amount of phosphate in the medium leads to increase in heterocyst production.
- (iii) The concentration of nitrogen in the medium above a certain level results in complete inhibition of heterocyst production.

FUNCTIONS OF HETEROCYST

Various function suggested by different workers are:-

- (i) They are considered as a weak link of the filament or trichome. Thus trichome breaks down from the heterocyst portion and help in the vegetative reproduction or in hormogonia formation.
- (ii) Heterocyst also helps in the formation of endospore. For example in *Nostoc commune* and *Anabaena cycadacearum* heterocyst helps in asexual reproduction.
- (iii) Some consider them to be the store houses of reserve food materials.
- (iv) In *Nostoc commune* and *Gloetrichia raciborski* they act as vestigial spores, which germinate and form new trichome on germination.
- (v) R.N. Singh (1961) and Fogg (1974) declared that the heterocysts are the site of nitrogen fixation in filamentous algae.
- (vi) According to Serpette (1948) heterocyst provide strength to the thallus.
- (vii) They promote the formation of akinete in the thallus.
- (viii) They are the site of oxyrespiration.
- (ix) In *Calothrix weberi* heterocyst act as a secondary reproductive structure.
- (x) According to Cannabacus (1929) there is a very close relationship between the heterocyst and gas vacuole formation.

NUTRITION IN CYANOBACTERIA

The cyanobacteria in general are obligate photoautotrophs because they can't grow in darkness even in the presence of organic nutrients in the substrate. The reserve food material is stored in the form of cyanophycean starch (a product of photosynthesis). Simon (1971) suggest that these cyanophycean starch granules are made up of polypeptide which contains only two amino acids viz. Arginine and Aspartic acid.

The capacity of cyanobacteria to assimilate and metabolise exogenous organic compound is very limited and they can't use organic compounds as a source of energy.

Movements: Despite the fact that blue green algae lack flagellated motile cells yet some genera like *Oscillatoria*, *Spirulina* and other show creeping or gliding movement in longitudinal direction of the longitudinal axis of a filament when in contact with a solid or semi-solid substrate. The movement is also accompanied by a clockwise or anti clock wise rotation of a trichome and is specific for a species. The filaments are usually in contact with a solid or semisolid substratum and their free ends show a slow or jerky but pendulum like oscillations. In *Oscillatoriaceae* the velocity of movement is usually well over $2 \mu\text{m sec}^{-1}$ and ranges up to $11 \mu\text{m sec}^{-1}$. The path covered by filament is not straight but a curved one.

Reproduction

The cyanobacteria reproduce by simple and primitive methods of reproduction which are vegetative and asexual. Sexual reproduction is absent however genetic recombination has been reported by Kumar (1962) and Bazin (1968). Shestakov and Khyen (1970) have reported genetic recombination in *Anacystis ridulans*.

Vegetative Reproduction

It is generally by fission, fragmentation and by the formation of hormogonia.

(i) **Fission:** The unicellular cyanophyceae (ex. *Synechocystis*) reproduce by this method called binary fission. This is the chief method of multiplication in the unicellular forms. The nuclear division (either by amitosis or mitosis) precedes the cell division. This is followed by cytokinesis. Under E.M. the cytokinesis reveals in filamentous algae as the involution of plasma membrane. This involution latter grows inward in the middle of the cell forming a cross plate between the two halves of the nuclear material. This divides the protoplast into two equal halves. With the centripetal growth of the cell membrane a ring-like septum arises from the inner layer of the cell wall and gradually grows inwards like a diaphragm with a decreasing aperture splitting the cross plate into two layers. Each daughter protoplast comes to possess a continuous plasma membrane. The completed septum or cross wall then thickens and finally divides into two layers, the ends of which are continuous with the inner layer of the parent cell wall. A constriction appears at the surface of the cross wall of the dividing cell exposing the fission between the daughter cells externally. As the daughter cells grows they set up the turgor pressure which pulls on their walls at the region of contact. The separation of daughter cells thus start at the periphery which proceeds towards the axis of the dividing cell gradually separating the two-daughter cells functioning as independent individuals.

(2) **Fragmentation:** This plays an important role in non-filamentous and filamentous colonies. Reaching a certain size, the colony breaks up into small parts. Each part/fragment is the beginning of a new colony which increases in size by repeated cell division.

The fragmentation may also occur by mechanical means. It may result from the bites of the animals feeding on trichomes or stress caused by water currents or death of certain cells.

(3) **Hormogonia:** The trichomes of filamentous genera breaks up within the gelatinous sheath into short sections or segments of one-many uniform living cells. These short length cells of trichome are called hormogonia or hormogones. The hormogones are delimited either by the formation of heterocyst or by the development of bi-concave separation disc or necridia (dead cell).

In genera with terminal or no heterocysts the hormogonia are delimited by the formation from time to time of bi-concave, gelatinous separation discs (necridia) between some of the cells of the trichome. A living cell here and there in the trichome undergo lysis. Its protoplast breaks down to form viscous substance. The mucilage filled dead

cells are called necridia. The necridium loses turgidity with the result that the mutual pressure on the walls of the adjacent cells is released. They bulge out and become convex. These biconcave dead cells are also called the biconcave separation discs because these provide weak links and thus serve to break the trichome into hormogones. The hormogones may be 2-3 cells or several cells long.

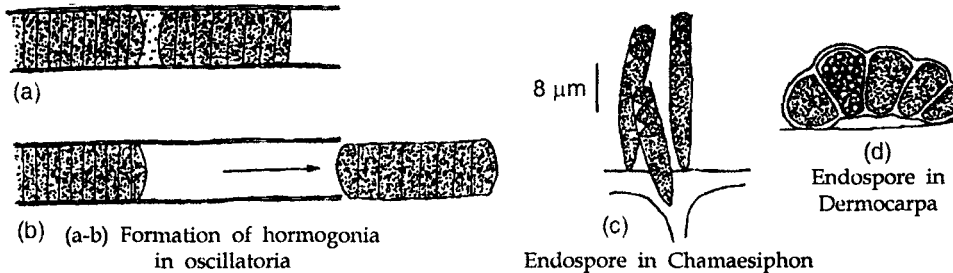

Fig. 4 : Member of Cyanophyceae showing different method of vegetative reproduction

Asexual Reproduction

The member of cyanophyceae reproduce by the formation of non-motile, asexual spores which are of various sorts.

(1) **Akinetes:** These are thick walled 'resistant resting' cells which are frequently developed singly next to a heterocyst. These spore like structure contain the entire protoplast of the cell and have the original parent cell wall as the outer portion of the spore wall.

Seenayya and Suba Raju (1970) observed that phosphorous deficiency of water resulted in increased production of akinete bearing trichomes in *Anabaenopsis raciborskii*. These akinetes are modified ordinary vegetative cells. Cell increase in size and accumulates food reserves. They are yellow brown in colour cell wall is highly resistant and is often differentiated into two layers.

With the onset of conditions (favourable) akinetes absorb moisture, the thick, resistant wall softens and the protoplast awakens to activity. Prior to emergence through the end of the softened or ruptured akinete wall the protoplast may undergo many transverse divisions or it may not undergo the first transverse division and protrudes out of the ruptured wall. The germling (the filamentous forms) behaves like a hormogonium.

Akinete formation: The initial step is the cell enlargement which is the first step towards differentiation of vegetative cell into akinete. This is followed by condensation of the mucilaginous sheath and formation of a dense fibrillar layer over the cell surface. Simultaneously there is deposition of several additional spore wall layers between the fibrillar layer and inner investment and of cyanophycean granules in the periphery of the cytoplasm. The mature akinete retains cyanophycean and also the thylakoid, polyhedral bodies, lipid deposits and nucleoplasm regions.

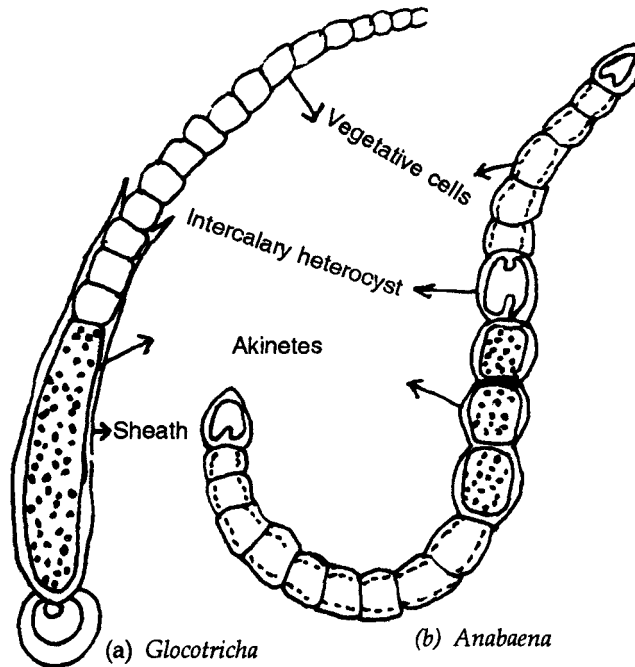

Fig. 5 : Cyanophyceae-Distribution of Akinetes

(2) **Endospores:** These are small spores formed endogenously within a vegetative cell of the unicellular or cushioned forms of chamaesiphonales which do not form hormogonia. At the time of endospore formation the vegetative cell increases in size. The protoplast divides by the method of successive bipartition. A large number of small, uninucleated daughter protoplasts are formed. Each daughter protoplast secretes a wall around it to become an endospore. The endospore wall is secreted on liberation. The spore wall is quite distinct from the wall of parent cell. The liberated endospore germinates immediately without a resting period. eg. *Dermocarpa pacifica*.

(3) **Exospores:** In *Chamaesiphon* the cell wall ruptures at the distal end of the vegetative cell. The spores are successively pinched off at the exposed end of the extruded protoplast. They are called exospores. Each exospore is surrounded by a delicate membrane.

(4) **Nannocytes:** Some non-filamentous blue-green algae such as *Microcystis* the cell content divide repeatedly without any cell enlargement. The successive division follow closely one upon the other. Numerous daughter cells are produced in each parent cell. These are called nannocytes. These nannocytes are naked protoplast. They are extremely small in size, closely packed which germinate *in situ* to give rise to new typical colonies.

(5) **Hormospores or Hormocyst:** Some members like *Wiestiella* produces a thick walled cells in the hormogonia segment. These structures are known as hormospores which on germination give rise to new thallus.

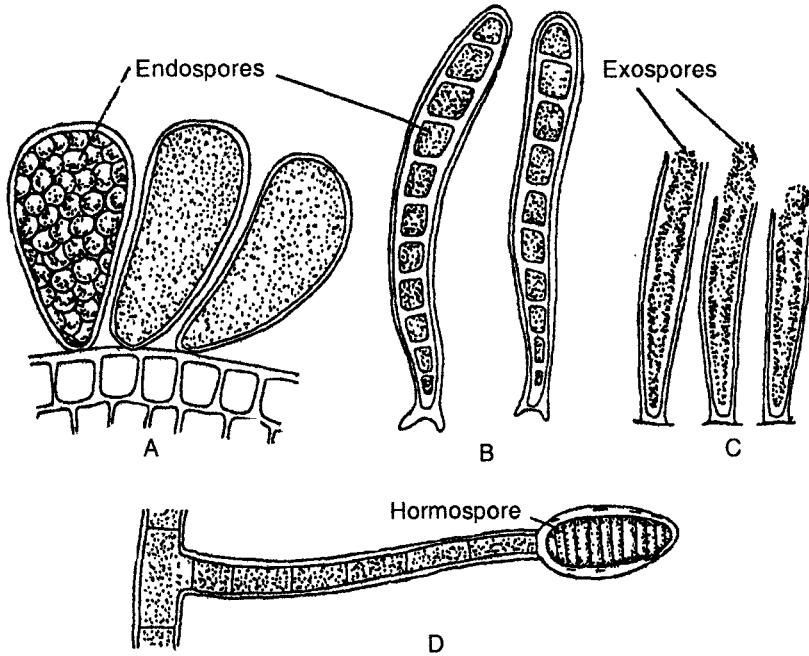
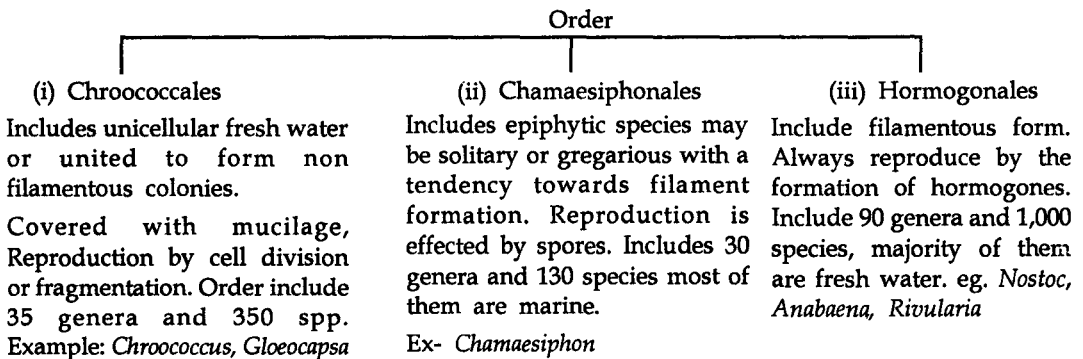

Fig. 6 : Cyanobacteria showing various types of spores.
 (a) & (b) Endospores (c) Exospores (d) Hormospores

Sexual Reproduction or Genetic Recombination

True sexual reproduction is totally absent in cyanophyceae. Kumar (1962) reported a type of genetic recombination in the member *Anacystis nidulans*. It is a type of parasexuality. It is also found in *Anabaena* and *Cylindrospermum*. There is a transfer of genetic material between two mating cells. The transfer process is slow in comparison to the bacteria.

Classification: According to G. Smith, the cyanophyceae is divided into three main orders which differ from one another in their vegetative structure and methods of reproduction. These three orders are :



Fritsch (1935) has divided the class into five orders on the basis of presence or absence of hormogonia.

Without Hormogonia

- Order I Chroococcales:** Unicellular or colonial (commonly palmelloid). Multiplication by cell division and by endospores eg. (*Microcystis*, *Chroococcus*, *Gloeocapsa*).
- Order II Chamaesiphonales:** Unicellular or colonial, epi or lithophytes exhibiting marked polarity. Multiplication by endo or exospores. eg. *Chamaesiphon*, *Dermocarpa*.
- Order III: Pleurocapsales:** Heterotrichous filamentous types, devoid of heterocyst. Multiplication by endospores eg. *Pleurocapsa*, *Hyella*

With Hormogonia

- Order IV: Nostocales:** Non-heterotrichous filamentous types-often showing false branching. Heterocysts commonly present. Multiplication by hormogonia, hormocysts and akinetes. This comprises of four families :
- (1) Oscillatoriaceae eg. *Oscillatoria*.
 - (2) Nostocaceae eg. *Nostoc*.
 - (3) Rivulariaceae eg. *Rivularia*.
 - (4) Scytonemataceae eg. *Scytonemna*.
- Order V Stigonematales:** Heterotrichous filamentous types with true branching mostly with heterocysts and usually showing clear pit-connections between the adjacent cells. Multiplication by hormogonia and hormocysts rarely by akinetes eg. *Stigonema*, *Mastigocladus*, *Westiella*.

GRAM -ve BACTERIA

There are a number of important gram-negative bacteria that are not closely related to the gram-negative proteobacteria. They include several physiologically and morphologically distinctive photosynthesizing bacteria, such as those included in the phyla cyanobacteria, chlorobi (green sulphur bacteria) and chloroflexi (green nonsulphur bacteria). The cyanobacteria produce oxygen during photosynthesis, and the green sulphur and green non-sulphur bacteria do not produce oxygen.

The gram-negative eubacteria include a number of species that are obligately anaerobic. The gram-negative fermentative bacteria are capable of fermenting a wide range of sugars, amino acids and other organic acids, some are capable of fumarate or nitrate-linked respiration. They are characteristic symbionts within the alimentary tract of homeothermic animals.

1. Spirochete
2. Rickettsia
3. Chlamydia
4. Gliding Bacteria
5. Sheathed Bacteria
6. Chemolithotrophs
7. Anoxygenic and Oxygenic Phototrophic Bacteria
8. Cyanobacteria
9. Purple Bacteria
10. Green Bacteria
11. Budding Bacteria

SPIROCHETES

The Spirochetes are a heterogenous group of bacteria that have a distinctive cell structure: their body is slender unicellular helical or spiral and is intertwined with an organelle termed the axial filament, a bundle of fibrils that winds around the cell body. The cytoplasm is surrounded by a cytoplasmic membrane and a peptidoglycan layer contributes to cell rigidity and shape. The individual fibrils that compose the axial filament originate near the ends of the cell and are normally more than half the length of the cell. Spirochetes have a typical gram-negative cell wall and a well developed periplasmic space that encloses the flagella called endoflagella (axial filament). Endoflagella are constrained somewhat like limbs in a sleeping bag, their flexing propels the cell by rotation and even crawling motions.

The fibrils of the axial filament have a fine structure essentially the same as that of flagella; a basal body containing a series of disks; a hook; and the filament itself. The number of disks varies among the spirochetes: *Leptospira* typically has two pairs of disks, whereas most other spirochetes have a single pair of disks. The filaments are often enveloped in a proteinaceous sheath unlike the eubacterial flagellum which, if sheathed, is surrounded by an extension of the outer membrane. The close structural and chemical resemblance between the axial fibril and the flagellum, as well as their similar role in motility, suggests that they are homologous organelles. The term endoflagella and periplasmic flagella have accordingly been proposed to describe axial fibrils.

The spirochetes are classified in the order spirochaetales which contain two families and five genera. The majority of spirochetes are free living saprobes or commensals of animals and are not primary pathogens. But three genera that contain major human pathogens are *Treponema*, *Leptospira* and *Borrelia*.

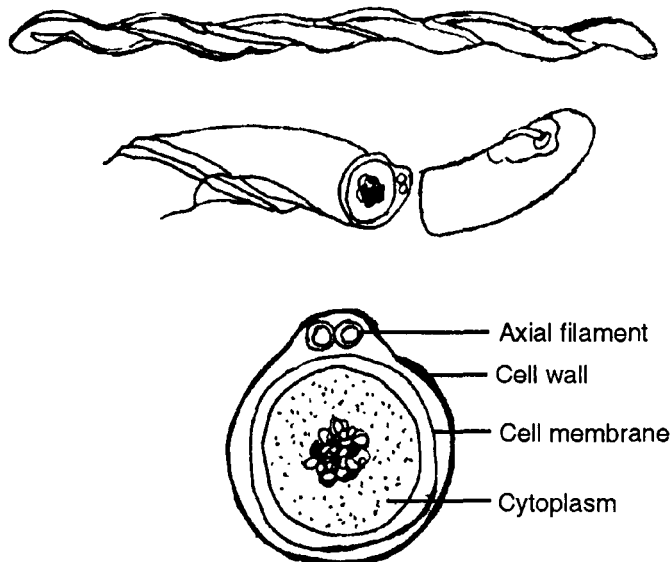

Fig. 1 : Ultrastructure of Spirochetes

Movement in Spirochetes

Spirochetes are all very actively motile, exhibiting a variety of translational and non translational movements. Among the latter are twisting, lashing and writhing movements that are characteristic of the group. Since these movements are very rapid and since the cells are often so thin as to be at the edge of detection with the light microscope, they look as if they were instantaneously moving from one position to another. On surfaces, spirochetes can glide, a motility often termed creeping rather than gliding. They also exhibit an 'inchworm' kind of motility, in which one end of the cell attaches to the surface, and the other end attaches nearby; the first end then detaches and reattaches at a distance. Repetition of these steps results in relatively rapid movement.

The axial filament has long been suspected to play a role in motility, suspicion that was strengthened when the structural resemblance between their constituent fibers and bacterial flagella was recognized. The isolation of immotile mutants with altered axial fibrils confirms the role of endoflagella in motility.

Nevertheless, it is still unclear how motion is actually effected. Because of the structural homology between flagella and endoflagella, it is tempting to propose that they share a similar mechanism, namely rotation from the base of the filament. How endoflagellar rotation would result in cell movement is controversial. However it is clearly not due to rotation of the cell as a whole; rather a helical wave is propagated down the cell. Two fundamental mechanisms are envisaged-rotation of flexible endoflagella may cause the rigid helical murein-bound protoplast to rotate within the outer membrane or rotation of the rigid helical endoflagella may cause the liable cell body to flex in the form of a helical wave.



Fig. 2 : Movement in spirochete

TABLE 1

Characteristic Features of Spirochetes in Pure Culture

S.No.	Characters	<i>Treponema</i>	<i>Borrelia</i>	<i>Leptospira</i>
1.	Cell diameter	0.1-0.4 μm	0.2-0.5 μm	0.1 μm
2.	Relationship to O_2	Anaerobe	Microaerophile	Aerobe
3.	Energy metabolism	Fermentative	Fermentative	Respiratory
4.	Percent G + C	22-54	Unknown	35-52
5.	Carbon and energy source	Sugars or Amino acids	Sugars	Fatty acid or fatty alcohols

Contd...

...Contd.

S.No.	Characters	<i>Treponema</i>	<i>Borrelia</i>	<i>Leptospira</i>
6.	Requires fatty acids for lipid synthesis	+	+	+
7.	Monogalactoyl diglyceride	+	+	-
8.	3-O-methyl-mannose in cell envelop	-	-	+
9.	Murein diamino acid	Ornithine	Ornithine	Diaminopimelate
10.	Habitat	Oral cavity, intestinal and genital tracts	Systemic pathogen of humans and arthropods	Soil, mammalian kidney

TABLE 2
Principal Human Diseases Caused by Spirochetes

Organisms	Disease	Distribution	Primary mode of Transmission	Animal Reservoirs
<i>Treponema pallidum</i>	Syphilis	Worldwide	Sexual-congenital	None
<i>T. endemicum</i>	Bejel	Arid, subtropical or temperate areas	Mouth to mouth [utensils via]	None
<i>T. carateum</i>	Pinta	Arid, Tropical America	Skin to skin contact	None
<i>Borrelia sp.</i>	Endemic relapsing fever	Worldwide	Tick bites	Yes
<i>B. burgdorferi</i>	Lyme disease	Worldwide	Tick bites	Yes
<i>B. recurrentis</i>	Epidemic relapsing fever	Central, East Africa, South American Andes	Louse bites	None

Cell Division in the Spirochetes

Mostly spirochetes are unicellular and divide by binary fission. One of the first detectable steps in division is the appearance of a new set of endoflagella originating at the middle of the cell. A septum then is laid down between the basal bodies, and the two daughter cells separate. However, such coupling between cell division and cell separation is not universal, there are strains of spirochaeta that are multicellular filaments up to 250 μm long.

Diversity of Spirochetes

Lipids are a major part of the spirochetes cell mass. All but leptospirens contain monogalactosyl-diglyceride as one of their polar lipids; *Borrelia* also contains cholesterol. The envelope of many spirochetes contains substantial amounts of polysaccharide of varying composition. The presence of 3-O- methylmannose in this carbohydrate fraction is characteristic of *Leptospira*.

Spirochetes are free living and characteristically inhabit anaerobic or microaerobic sediments. They have a high sulfide tolerance, important in sediments that support active sulphur reduction. They ferment carbohydrates via the Embden-Meyerhoff pathway to pyruvate, which is cleaned by a clostridial-type classic reaction to acetyl Co-A. Fermentation products are ethanol, acetate, CO₂ and H₂

Treponema includes a number of parasitic but not pathogenic anaerobes. They include both amino acid-fermenting and carbohydrate fermenting strains produce acetate and butyrate as major products, sometimes accompanied by varying amounts of succinate or lactate, and ethanol and butanol. The amino acid fermenting strains produce principally acetate, with varying amounts of propionate, butyrate or lactate.

The Leptospirens are the only obligately aerobic spirochetes. They require fatty acids not only as precursors of membrane lipids, but also as their respiratory substrate, they cannot respire carbohydrates or other compounds. They have a characteristic morphology, the posterior end of swimming cells is always hooked, while the anterior end is straight or helical, immobile cells may be hooked at both ends.

Symbiosis with Invertebrate Animals

The hindgut of termites and wood-eating roaches is a fermentation chamber in which ingested cellulose is fermented by the microbial inhabitants. The microbial flora of many of these insects is characterized by flagellate protozoa and by large spirochetes, many of which are attached to the surface of the protozoa. Several genera have been proposed for these spirochetes; their collective name is pillotinas after the generic name of one of them. In some cases it is clear that the attached pillotinas provide motility for the host protozoan; the flagella steer, while the propulsive force is due to coordinated swimming motions by the spirochetes. The pillotinas are a morphologically diverse group; they characteristically have a large number of endoflagella, and their outer membrane is often crenulated or grooved.

Treponema pallidum

[The Spirochete of Syphilis]

The human is evidently the sole natural host and source of *T. pallidum*. It is an extremely fastidious and sensitive bacterium that cannot survive for long outside the host, being rapidly destroyed by heat, drying, disinfectants, soap, high oxygen tension and pH changes. It survives a few minutes to hours when protected by body secretions and about 34 hrs in stored blood.

Infection is usually acquired by sexual contact with infected individuals, and is

commonest in the most sexually active age group of 15-30 yr olds. Rarely, syphilis has been acquired by transfusion of infected fresh human blood.

Primary Syphilis: The earliest indication of syphilis infection is the appearance of a hard chancre at the site of inoculation, after an incubation period that varies from nine days to three months. The chancre begins as a small, red, hard, bump that enlarges and breaks down, leaving a shallow crater with firm margins. The base of the ulcers beneath the encrusted surface swarms with spirochetes. The chancre heals spontaneously without scarring in three to six weeks, but this healing is deceptive, because the spirochete has escaped into the circulation and is entering a period of tremendous activity.

Secondary Syphilis: About 3-6 months after the chancre (an injurious sore) heals, the secondary stage appears. By then, many systems of the body have been invaded and the symptoms are more profuse and intense. Initially there is fever, headache and sore throat, followed by lymphadenopathy and a peculiar red or brown rash that breaks out on all skin surfaces, including the palms and the soles. The major complications develop in the bones, hair follicles, joints, liver, eyes, brain and kidneys.

Borrelia

[Relapsing Fevers]

Epidemic or tick borne relapsing fever is caused by several *Borrelia* sp. Including *B. duttoni*, *B. hermsii*, *B. parkeri* and *B. turicatae*, and is transmitted to humans by soft bodied ornithodoros ticks. The natural hosts for these organisms include rodents and other small mammals on which the ticks normally feed.

Epidemic or louse-borne relapsing fever is caused by *B. recurrentis*, an obligate human pathogen transmitted from person to person by the body louse, *Pediculus humanus*.

The spirochetes causing the two forms of relapsing fever differ in their mode of growth in the arthropod vector, and this influences the way human infection is initiated.

B. recurrentis grows in the haemolymph of the louse but does not invade tissues. As a result the excrement of the louse is non-infectious and the bacterium is not transferred transovarially to the progeny. Human infection occurs when bacteria released from crushed lice gain entry to tissues through damaged or intact skin or mucous membranes. Transovarial transmission to the tick progeny maintains the spirochete in the tick population.

In both forms of relapsing fever, acute symptoms, including high fever, rigors, headache, myalgia, arthralgia, photophobia and cough, develop about one week after infection. A skin rash may occur and there is central nervous system involvement in up to 30% of cases. During the acute phase there may be up to 10^5 spirochetes per cubic millimeter of blood. The primary illness resolves within 3-6 days, and terminates abruptly with hypotension and shock, which may be fatal. Relapse of fever occurs 7-10 days later, and several relapses may take place.

Lyme Disease

Lyme disease is a recently described syndrome, originally called Lyme arthritis. Its

spirochetal agent, *Borrelia burgdorferi* is transmitted primarily by hard ticks of the genus *Ixodes*. The adult tick reproductive phase of the cycle is completed on deer.

The natural host for *B. burgdorferi* are wild and domestic animals, including mice and other rodents, deer, sheep, cattle, horses and dogs. The larger animal hosts such as deer are probably more important in maintaining the size of the tick populations rather than acting as a major source of *B. burgdorferi*.

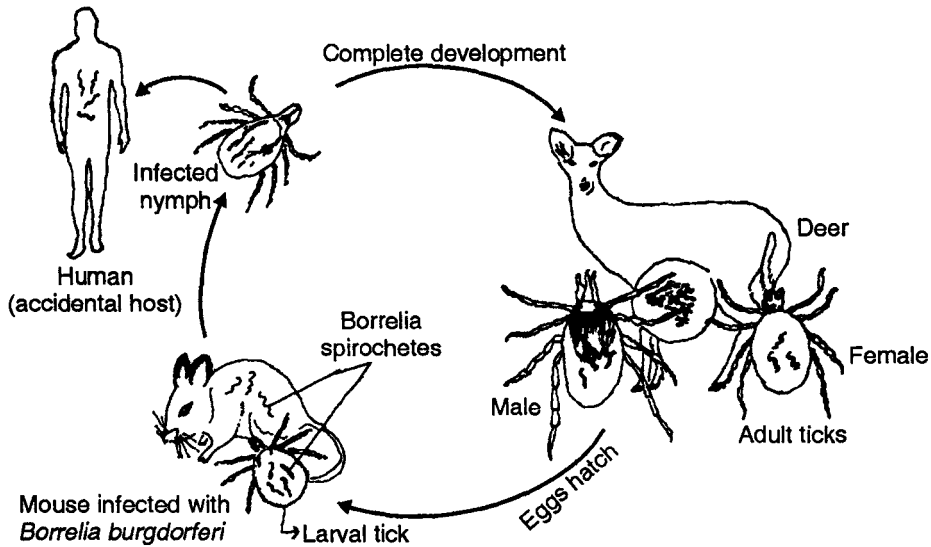

Fig. 3 : The cycle of lyme disease

Lyme disease is nonfatal but often evolves into a slowly progressive syndrome that mimics neuromuscular and rheumatoid conditions. An early symptom in 70% of cases is a rash at the site of a larval tick bite. The lesion, called erythema migrans, looks something like a bull's eye, with a raised erythematous ring that gradually spreads outward and a pale central region. Other early symptoms are fever, headache, stiff neck and dizziness. If not treated or if treated too late, the disease can advance to the second stage, during which cardiac dysrhythmias and neurological symptoms such as facial palsy develop. After several weeks or months, a crippling polyarthrititis can attack joints, especially in the European strain of the agent. Some people acquire chronic neurological complications that are severely disabling.

RICKETTSIA

The rickettsia are named after H.T. Ricketts, who discovered American 'Rocky Mountain spotted fever'. This group is also referred to as the 'Spotted fever' (typhus fever) group after the disease produced by the best known of these pathogens (*Rickettsia prowazekii*). Their natural distribution is by host vectors such as lice, fleas, ticks, mites, etc in which they exist as harmless parasites or even symbionts. On being transferred to other animal hosts or humans by bites, scratches or inhalation, they produce very serious disease symptoms.

The Rickettsias are small rods with the fine structure typical of gram-negative eubacteria. The genera *Rickettsia* and *Coxiella* are obligate intracellular parasites that differ in their location within the host cell. Both enter their host cells by inducing phagocytosis, even by cells that are not normally phagocytic. Within host cells, the rickettsias reproduced by binary fission. They cling together in pairs after fission. Rickettsias are not motile as no flagella have been observed. They do not produce endospores. The organisms were considered to be the product of 'degenerative evolution' of bacteria as a result of obligate intracellular parasitism. The DNA extracted from rickettsias is double stranded the organisms are capable of generating their own ATP as evidenced by oxidation of amino acid and glutamate.

Coxiella forms endospores that are resistant to drying and other environmental stresses. They are substantially smaller than the vegetative cells, appear to have a reduced metabolic rate, and they lack dipicolinic acid, a compound characteristic of the endospores of gram-positive bacteria.

The rickettsias cause several human diseases which are transmitted by arthropod vectors such as fleas, mites, lice and ticks. They are apparently not pathogenic to these arthropods but are pathogenic to man and other animals. Some diseases of man are fatal eg. The typhus fever which is epidemic caused by *R. prowazekii*, transmitted to man by body lice. The disease is characterized by abrupt severe ache, fever, and chills followed by rash on back and chest.

TABLE 3
Human Diseases Caused by Rickettsia Species

Species	Disease	Geographical distribution	Mode of transmission	Primary vectors	Main vertebrate hosts
Typhus group					
<i>R. prowazekii</i>	Epidemic typhus	Extant foci in Africa, North and South America	Louse faeces	<i>Pediculus humanus corporis</i>	Humans, flying squirrels
<i>R. typhi</i>	Murine typhus	Primarily tropics and subtropics	Flea faeces	<i>Xenopsylla cheopis</i> and other fleas	Rodents & other small mammals
Spotted fever group					
<i>R. akari</i>	Rickettsial pox	USA, Ukraine, Croatia, Korea	Bite of mouse mite	<i>Liponyssoides sanguineus</i>	House mice; possibly other rodents
<i>R. australis</i>	Queensland tick typhus	Australia	Bite of tick	<i>Ixodes holocyclus</i>	Unknown
<i>R. conorii</i>	Boutonneuse fever	Europe, Africa, Middle East, India	Bite of tick	<i>Rhipicephalus</i>	Rodents & other small mammals

The other important rickettsial disease of humans is the 'rocky mountain spotted fever' caused by *Rickettsia rickettsi* transmitted by ticks. Ticks that acquire the infection remain infective for a life time.

The genus *Rickettsia* is currently divided into two antigenically distinct group and the spotted fever group, which are very closely related. They have a typical gram-negative bacterial cell wall, including a bilayered outer membrane that contain the lipopolysaccharide antigens that distinguish the two groups. External to the outer membrane there appears to be a slime layer, probably composed of polysaccharides. Electrophoresis has demonstrated a number of distinct and common proteins in both groups of rickettsiae. The immunodominant rickettsial outer membrane proteins A (Omp A) has been studied principally in the spotted fever group rickettsiae. It contains a hydrophilic region of tandem repeat units that determine the diversity of molecular size and antigens largely by the number, order and type of repeat units. Omp B is a typical autotransporter protein and is abundant in both groups of rickettsiae. Omp A and Omp B both contain cross reactive and species-specific epitopes.

Pathogenesis

Rickettsiae normally enter the body through the bite and dust from hides or pelts of infected animals may contain large numbers of highly infectious spores from dried fecal material of arthropod parasites such as ticks. They are disseminated through the blood stream, enter endothelial cells by induced phagocytosis, escape from the phagosome, multiply intracellularly and eventually destroy their host cells. Observations in cell culture systems suggest that spotted fever and typhus group rickettsiae destroy the host cell by different mechanism.

A common target in rickettsial infections is the endothelial lining of the small blood vessels. The bacteria recognize, enter and multiply within endothelial cells, causing necrosis of the vascular living. Among the immediate pathological consequences are vasculitides, perivascular infiltration by inflammatory cells, vascular leakage and thrombosis. These pathologic effects are manifested by skin rash, edema, hypotension and gangrene.

Intravascular clotting in the brain accounts for the stuporous mental changes and other neurological symptoms that sometimes occur.

Specific Rickettsioses

Rickettsioses can be differentiated on the basis of their clinical features and epidemiology as:

1. Classical, epidemic or louse borne typhus.
2. Murine, endemic or flea borne typhus.
3. Tropical, scrub or mite borne typhus.
4. Spotted fevers, and
5. Q. fever

TABLE 4
Characteristics of Rickettsias Important in Human Disease

Disease	Species	Disease	Vector	Primary Reservoir	Mode of Transmission to Humans	Where Found
Typhus	<i>R. prowazekii</i>	Epidemic typhus	Body louse	Humans typhus	Louse faeces rubbed into bite; inhalation	World wide
	<i>R. typhi</i> (<i>mooseri</i>)	Murine typhus	Flea	Rodents	Flea faeces rubbed into skin; inhalation	World wide
Spotted Fever	<i>R. rickettsii</i>	Rocky mountain spotted fever	Tick	Small mammals	Tick bite; aerosols	North & South America
	<i>R. akari</i>	Rickettsial pox	Mite	Mice	Mite bite	World wide
Scrub Typhus	<i>R. tsutsugamushi</i>	-	Chigger	Rodents	Chigger bite	Asia, Australia, Pacific Islands
Q Fever	<i>Coxiella burnetii</i>	-	Tick	Cattle, Sheep, goats	Airborne; contact with ticks	Worldwide
Trench Fever	<i>Bartonella quintana</i>	-	Body louse	Humans	Louse faeces scratched into bite	Africa, Mexico, Europe
Cat-Scratch Disease	<i>Bartonella henselae</i>	-	Domestic cat	Cat	Scratches, bites	World wide

Epidemic Typhus

[Louseborne typhus, Classical typhus, Goal fever]

The causative agent of epidemic typhus is *R. prowazekii* named after von Prowazete, who died of typhus fever while investigating the disease. Humans are the only natural vertebrate hosts. Several animals—guinea pigs, mice, cotton rats and gerbils—may be infected experimentally. The human body louse *Pediculus humanus corporis* is the vector. The head louse may also transmit the infection but not the public louse. The lice become infected by feeding on rickettsiaemic patients. The rickettsiae multiply in the gut of the lice and appear in the feces in 3-5 days. Lice succumb to the infection within 2-4 weeks, remaining infective till they die. The lethal nature of the infection in the louse suggests that the association between *R. prowazekii* and its vector is relatively recent and not well established. Lice may be transferred from person to person. Infection is transmitted when the contaminated louse feces is rubbed through the minute abrasions caused by scratching. The disease starts with fever and chills. A characteristic rash appears on the fourth or fifth day, starting on the trunk and spreading over the limbs but sparing the face, palm and soles. Towards the second week, the patient becomes stuporous and delirious. The name typhus comes from the cloudy state of consciousness in the disease (from typhos, meaning cloud or smoke).

Endemic Typhus

[Murine or Fleaborne typhus]

It is a milder disease than epidemic typhus. It is caused by *R. typhi* which is maintained in nature as a mild infection of rats, transmitted by the rat flea *Xenopsylla cheopis*. The rickettsia multiplies in the gut of the flea and is shed in its feces. The flea is unaffected but remains infectious for the rest of its natural span of life.

Humans acquire the disease usually through the bite of infected fleas, when their saliva or feces is rubbed in or through aerosols of dried feces. Ingestion of food recently contaminated with infected rat urine or flea feces may also cause infection. Human infection is a dead end. Man to man transmission does not occur.

The clinical manifestations of endemic typhus include fever, headache, muscle aches, and malaise. After five days, a skin rash, transient in milder cases, begins on the trunk and radiates toward the extremities. Symptoms dissipate in about two weeks. Tetracycline and chloramphenicol are effective therapeutic agents, while various pesticides are available for vector and rodent control.

Scrub Typhus

Tsutsugamushi Disease

The illness caused by *R. tsutsugamushi*. Scrub typhus rickettsias live naturally in the bodies of chigger mites. Infected mammalian and avian hosts help perpetuate the reservoir. Humans are attacked by chiggers (mite larvae) while passing through forests and parkland. The mite feeds on the serum of warm blooded animals only once during its cycle of development and adult mites feed only on plants. The microbes are transmitted transovarially in mites. Various rodents and birds act as reservoirs.

At the site of a mite bite, a distinctive black scab develops in one to three weeks. Early symptoms of fever, headache and muscle aches resemble those of endemic typhus and in about half the cases, a generalized rash originates on the trunk and radiates peripherally. Severe cases are accompanied by mental confusion, delirium, pneumonia and circulatory collapse.

Rocky Mountain Spotted Fever

Rickettsia of this group possess a common soluble antigen and multiply in the nucleus as well as in the cytoplasm of host cells. *R. rickettsii*, the etiological agent of Rocky Mountain spotted fever, discovered by Ricketts in 1906 in smears from infected animals and patients, and later discovered that it was transmitted by ticks, which therefore act as both vectors and reservoirs. The infection may be transmitted to vertebrate hosts by any of the larval stages or by adult ticks. Ticks are not harmed by the rickettsia and remain infected for life. The rickettsia are shed in tick feces but transmission to human beings is primarily by bite, as the rickettsia also invade the salivary glands of the ticks. All rickettsia of this group pass through natural cycles in domestic and wild animals or birds.

Pathogenesis: After two to four days incubation, the first symptoms are sustained fever, chills, headache and muscular pain. The distinctive spotted rash usually comes on

within two to four days after the prodromium. It starts on the wrist and ankles, moves to the arms and legs, converges toward the chest and eventually covers the entire body. Early lesions are slightly mottled like measles, but later ones are macular, maculopopular and even- petechial.

In severe cases, the enlarged lesions merge and can become necrotic, predisposing to gangrene of the toes or finger tips. Other grave manifestations of diseases are cardiovascular disruption, including hypotension, thrombosis, and hemorrhage. Conditions of restlessness, delirium, convulsions, tremor and coma are signs of the often overwhelming effects on the central nervous system.

Q. Fever

As the etiological agent of the disease was unknown, it was referred to as 'Query' or Q fever. As Burnet identified the causative agent as a rickettsia, it was named *R. burnetii*, later named *Coxiella burnetii*. This is highly resistant due to its production of an unusual type of spores and it is apparently harbored by a wide assortment of vertebrates and arthropods, especially ticks. Arthropod vectors play an essential role in transmitting the rickettsia between wild and domestic animals, but transmission to humans is largely by means of environmental contamination and airborne spread.

Sources of infectious material include urine, feces, milk and air borne particles from infected animals. The primary portals of entry are the lungs, skin, conjunctiva, and gastrointestinal tract. People at highest risk are farm workers meat cutters, wool and leather workers and lab technicians. The clinical manifestations typical of *Coxiella* infection are abrupt onset of fever, chills, headache, muscle ache but rarely are skin rashes seen.

Trench Fever: The causative agent is *Bartonella Quintana*, like epidemic typhus, cycles between humans and lice, but unlike the typhus rickettsia, does not multiply intracellularly and does not kill the louse vector. Highly variable symptoms can include a 5-6 day fever, leg pains, especially in the tibial region, headache, chills and muscle aches.

Cat-scratch Disease: Infection connected with a cat scratch or bite. The symptoms start after 1-2 weeks, with a cluster of small papules at the site of inoculation. In a few weeks the lymph nodes along the lymphatic drainage swell and can become pus-filled.

CHLAMYDIA

The Chlamydias are Gram-negative eubacteria that are obligate intracellular parasites and that like *Coxiella*, have a life cycle that includes a resistant stage that mediates transmission. Chlamydia are obligate intracellular bacterial parasite of humans, animals and birds with tropism for squamous epithelial cells and macrophages of the respiratory and gastrointestinal tracts. They possess both DNA and RNA, have cell wall and ribosomes, replicate by binary fission without an eclipse phase and are susceptible to the usual antibiotics and chemotherapeutic agents.

Chlamydias alternate between two distinct stages:

(A) A small metabolically inactive, infectious form called the elementary body that is released by the infected host cell, and

(B) A larger noninfectious, actively dividing form called the reticulate body that grows within the host cell vacuoles. This terminology was devised prior to the full realization of the bacterial nature of the chlamydias.

Elementary bodies are tiny, dense spheres shielded by a rigid, impervious envelope that ensures survival outside the eukaryotic host cell. Reticulate bodies are finely granulated and have thin cell walls.

To emphasize the homology of cellular processes in the chlamydias and other bacteria, we shall call the actively growing cell (reticulate body)-vegetative cell and the infectious form (elementary body).

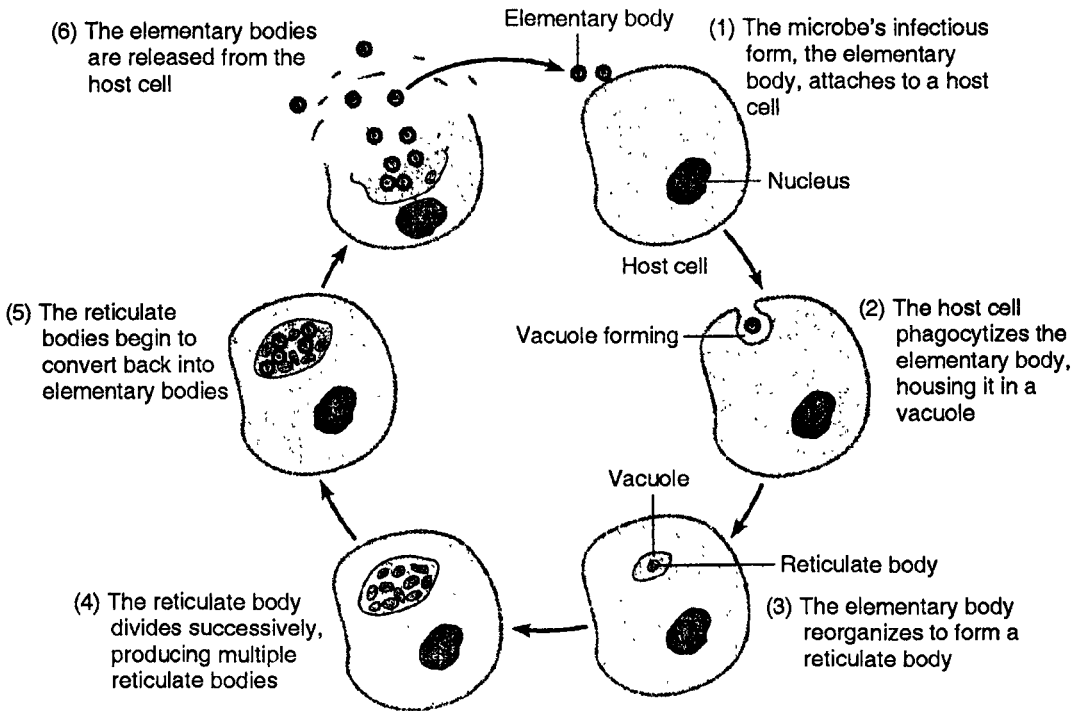

Fig. 4 : Life cycle of Chlamydia

Chlamydiospores

The chlamydiospore is small, with a rigid cell wall; they lack detectable metabolic activity. When it contacts a host cell, it includes phagocytosis by the host cell; the rest of the life cycle occurs within the phagosome. Some component of the chlamydiospores inhibits the fusion of phagosome with lysosomes; presumably there are other changes in the phagosomes membrane that allow permeation by host metabolites needed by the parasite. The chlamydiospore enlarges; loses its rigidity, and begins macromolecular synthesis. Since the chlamydiospore is very low in RNA; particular rRNA, initial protein and RNA synthesis is probably devoted to increasing the number of ribosomes. Following a period of growth and division by binary fission, the vegetative cells convert to chlamydiospores.

The genus *Chlamydia* contains four species: *C. trachomatis*; *C. psittaci*, *C. pneumoniae*, which can affect humans; and the fourth species; *C. pecorum* created recently to include some strains affecting ruminants.

Diseases of *Chlamydia trachomatis*

The reservoir by pathogenic strains of *Chlamydia trachomatis* is the human body. The microbe shows astoundingly broad distribution within the population, often being carried with no symptoms. Elementary bodies are transmitted in infectious secretions, and although infection can occur in all age groups, disease is most severe in infants and children.

Chlamydial Disease of the Eye: The two forms of chlamydial eye disease, ocular trachoma and inclusion conjunctivitis, differ in their patterns of transmission and ecology. Ocular trachoma, an infection of the epithelial cells of the eye, is an ancient disease and a major cause of blindness in certain parts of the world.

The first signs of infectious are a mild conjunctival exudates and slight inflammation of the conjunctiva. This is followed by marked infiltration of lymphocytes and macrophages into the infected area. In time, a vascular pseudomembrane of exudates and inflammatory leukocytes forms over the cornea, a condition called pannus that lasts a few weeks and usually heals. Complications contributing most to corn.

Transmission is favored by contaminated fingers, fomites, flies and a hot, dry climate.

GLIDING BACTERIA (THE MYXOBACTERIA)

These groups of bacteria are able to move by gliding or creeping. The gliding bacteria are a mixed collection of gram negative bacteria that live in water and soil. The name is derived from tendency of members to glide over moist surfaces. There are several morphologic forms, including slender rods, long filaments, cocci & some miniature tree shaped fruiting bodies.

A. Unicellular, rod shaped bacteria, including the mycobacteria, the *Cytophaga* group and *Flexibacter* groups.

B. The thread like gliding bacterium *Chloroflexus*

C. Bacteria that contain intracellular sulphur, of which there are trichome forming (*Beggiatoa*, *thiothrix*) and unicellular (*Achromatium*) organisms.

D. Sulphur-free bacteria existing as trichomes such as *Vitreoscilla*, *Leucothrix* and *Saprospira* as well as the mouth Oxillatoria *Simonsiella* and *Alysiella*.

E. Cyanobacteria, if they are motile at all, move by gliding.

The *Flexibacter* species are aquatic bacteria. They are long, very flexible cells but not multicellular. During continuous cultivation these become shorter and eventually fragment into coccoid cells. Many forms contain carotenoids and show yellow, pink or orange pigmentation.

Beggiatoa is a colourless, threadlike sulphur bacterium. The cells are filled with

sulphur droplets, which makes the colourless threads appear white. The threads are motile by gliding, *Beggiatoa* is an aerobic organism and looks like masses of spider's webs either covering the black putrid mud of slow moving waters or in the sea when water containing hydrogen sulphide is exposed to atmospheric oxygen. The sulphide is oxidized to sulphate. *Thiothrix* is not freely motile. Bunches or tufts of trichomes are attached by their bases to solid surfaces. Multiplication is by gonidia, which are formed by the rounding off of apical cells. Conidia can glide over solid surfaces. *Thiothrix* is much more widespread than *Beggiatoa* and grows in waters in which rotting organic material gives rise to hydrogen sulphide.

Vitreoscilla is a colourless, aerobic, multicellular, filamentous bacterium which moves by gliding and multiplies by fragmentation of the filaments. It can be isolated from cow dung. *Leucothrix* grows epiphytically on marine algae. The sulphur bacterium *Thiosphirillopsis floridana* and the organotrophic *Saprospira grandis* can be compared to the helically wound cyanobacterium *Spirulina*.

Myxobacteria are differentiated from other gliding chemoheterotrophs by their high G + C content and unicellular morphology. They are soil bacteria and are characterized in their natural habitat by the formation of fruiting bodies that are very small. Such fruiting bodies are found in decaying plant material, rotting wood, tree bark and on the faeces of herbivores. The vegetative cells are rods, which are usually quite flexible.

The myxobacteria are soil organisms and are usually detected in nature through the development of their fruiting bodies on solid substrates. Myxobacteria are strict aerobes that fall into two nutritional subgroups:-

(a) Bacteriolytic and (b) Cellulolytic organism

Most of the myxobacteria can lyse bacteria by exoenzymes, whilst only the genus *Polyangium* contains cellulolytic species.

What sets the myxobacteria apart from other bacteria is the complexity and advancement of their life cycle. During this cycle, the vegetative cells swarm together and differentiate into a many-celled, colored structure called the fruiting body. The fruiting body is a survival structure that makes spores by a method very similar to that of certain fungi. These fruiting structures are often large enough to be seen with the unaided eye on tree bark and plant debris.

On solid media myxobacteria form very extensive flat colonies. When the vegetative cells inside the colonies aggregate, they differentiate into fruiting bodies that differ in shape, size and pigmentation for the various genera and species of the myxobacteria. During maturation, the cells inside the fruiting bodies become dormant i.e., they are converted to myxospores.

The *Cytophaga* group contains the genera *Cytophaga* and *Sporocytophaga*. In contrast to the Myxobacteriales, the cytophagales do not produce fruiting bodies. Genera in the order cytophagales exhibit widely differing morphological forms and modes of metabolism. They are unified by the presence of gliding motion and lack of fruiting body formation. As a consequence of their hydrolytic activities, these gliding bacteria are important ecologically in the decomposition of organic matter.

THE SHEATHED BACTERIA

Some filamentous bacteria form tubular envelopes described as sheaths (*Sphaerotilus natans*, *Leptothrix ochracea*) these sheaths consist of heteropolysaccharide containing glucose, glucuronic acid, galactose and fructose. Sheathed Bacteria are rod shaped aquatic organisms that grow as chains of cells enclosed in tubular sheaths. These gram-negative bacteria with polar flagella form a hollow, filamentous sheath to live in. They are the

TABLE 5
The Sheathed Bacteria

Taxon	Description
Order Myxobacterales—	Produce Frutting Bodies
Family : Myxococcaceae	Vegetative cells tapered; microcysts spherical or oval
Genus : <i>Myxococcus</i>	
Family : Archangiaceae	Vegetative cells tapered; microcysts rod-shaped, not in sporangia
Genus : <i>Archangium</i>	
Family : Cystobacteraceae	Vegetative cells tapered; microcysts rod-shaped, in sporangia
Genera : <i>Cystobacter</i> , <i>Melittangium</i> , <i>Stigmatella</i>	
Family : Polyangiaceae	Myxospores resemble vegetative cells
Genera : <i>Polyangium</i> , <i>Nannocystis</i> , <i>Chondromyces</i>	
Order Cytophagales—	Frutting Bodies not Produced
Family : Cytophagaceae	Pigmented; filaments not attached
Genera : <i>Cytophaga</i> , <i>Flexibacter</i> , <i>Herpetosiphon</i> , <i>Flexithrix</i> , <i>Saprospira</i> , <i>Sporocytophaga</i>	
Family : Beggiatoaceae	Nonpigmented; filaments not attached; cells in cylindrical filaments
Genera : <i>Beggiatoa</i> , <i>Vitreoscilla</i> , <i>Thioploca</i>	
Family : Simonsiellaceae	Non pigmented; filaments attached, cells in flat filaments
Genera : <i>Simonsiella</i> , <i>Alysiella</i>	
Family : Leucotrichaceae	Filaments attached at one end
Genera : <i>Leucothrix</i> , <i>Thiothrix</i>	

cause of bulking, an important problem in sewage treatment. Reproduction occurs by the liberation of cells from the open apex of the sheath. Three principal genera, *Sphaerotilus*, *Leptothrix* and *Haliscomenobacter* are distinguishable. *Sphaerotilus* forms thin sheaths, normally without encrustations of metal oxides. It is found in slowly running streams contaminated with sewage or other organic matter, where it grows as long, slimy, attached tassels. It also develops in aerobic sewage digestors.

The formation of a sheath enables these bacteria to attach to solid surfaces. This is important to the ecology of these bacteria because many sheathed bacteria live in low nutrient aquatic habitats. By absorbing nutrients from the water that flows by the attached cells, these bacteria conserve their limited energy resources. Additionally, the sheaths afford protection against predators and parasites. In some cases, the sheaths may be covered with metal oxides. For example, in the genus *Leptothrix*, sheaths are encrusted with iron or manganese oxides. In other genera, such as *Haliscomenobacter*, this does not occur. In the genus *Sphaerotilus*, the sheath is sometimes encrusted with iron oxides.

Leptothrix is common in uncontaminated fresh water containing metal salts, where its sheaths are heavily encrusted with hydrated ferric or manganic oxides. *Haliscomenobacter* is abundant in aerobic sewage treatment systems. Its long, thin cells are enclosed in a barely visible sheath. *Sphaerotilus* is obligate chemoheterotrophs.

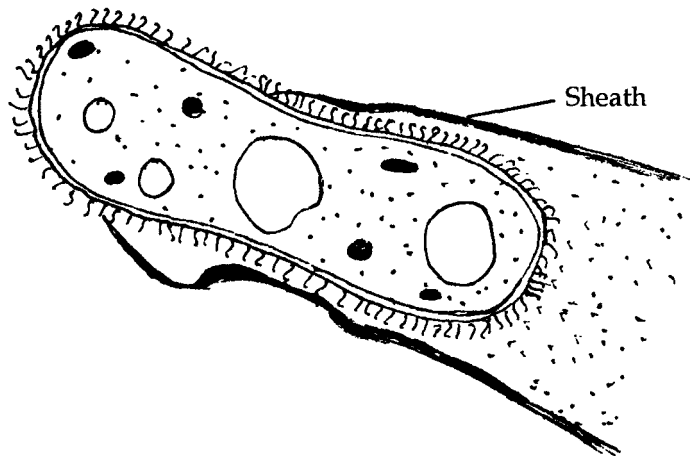

Fig. 5 : Micrograph of the bacterium *Leptothrix discophora*.
The cell is coming out of a sheath

Three Genera (Sheathed Bacteria)

Sphaerotilus

Forms thin sheath with encrustation of metal oxides. Found in slowly running streams contaminated with

Leptothrix

Common in uncontaminated fresh water, containing metal salts. Where sheath are heavily encrusted with

Haliscomenobacter

Abundant in aerobic sewage treatment system Long thin cells are enclosed in barely

sewage or other organic matter. Where it grow as long slimy, attached tassels. Also develops in aerobic sewage digesters. G + C – 69-71%	hydrated ferric or manganic oxides Obligate chemoheterohophs cell diameter 0.6-1.4 μm Holdfast motility present	visible sheath. Cell diameter 0.35- 0.45 μm Motility absent Hold fast absent G+C content 48-50%
Cell diameter 1.2-2.5 μm Motility Present, Hold fast present	G + C% 69-71 Fe ⁺² and Mn ⁺² oxidation	Mn ⁺² oxidation present

CHEMOLITHOTROPHS

Chemolithotrophs, a significant group of bacteria have such as extreme nutritional adaptation that they require neither sunlight nor organic nutrients. Chemolithotrophs utilize the energy present in chemical compounds and carbon in the form of carbon dioxide. Chemolithotrophic bacteria are very important to the biogeochemical cycling of various elements. These include organisms like *Beggiatoa* (utilizing hydrogen sulfide as energy source), *Nitrosomonas* (utilizing ammonia as energy source), *Thiobacillus* (utilizing iron), *Nitrobacter* (using nitrites) etc. These microorganisms have simpler nutritional requirements and can be grown on defined media. These organisms are the chief concern to man because all the parasites or pathogens of man, animals and plants are chemoheterotrophs. All the saprophytes are also chemoheterotrophs.

TABLE 6

Metabolism of Chemolithotrophs

Common Name of Organism	Source of Energy	Oxidation Reaction (Energy Yielding)	Important Features of Group	Common Genera in Group
Hydrogen bacteria	H ₂ gas	H ₂ + 1/2 O ₂ → H ₂ O	Can also use simple organic compounds for energy	<i>Hydrogenomonas</i>
Sulphur bacteria (non-photosynthetic)	H ₂ S	H ₂ S + 1/2 O ₂ → H ₂ O + S S + 1 1/2 O ₂ + H ₂ O → H ₂ SO ₄	Some organisms of this group can live at a pH of less than 1	<i>Thiobacillus</i> <i>Beggiatoa</i> <i>Thiothrix</i>
Iron bacteria	Reduced iron (Fe ²⁺)	2Fe ²⁺ + 1/2 O ₂ + H ₂ O → 2Fe ³⁺ + 2 OH ⁻	Iron oxide present in the sheaths of these bacteria	<i>Sphaerotilus</i> <i>Gallionella</i>
Nitrifying bacteria	NH ₃	NH ₃ + 1 1/2 O ₂ → HNO ₂ + H ₂ O	Important in nitrogen cycle	<i>Nitrosomonas</i>
	HNO ₂	HNO ₂ + 1 1/2 O ₂ → HNO ₃	Important in nitrogen cycle	<i>Nitrobacter</i>

These bacteria live in seemingly inhospitable environments such as sulphur hot springs, which are rich in reduced inorganic compounds such as hydrogen sulfide. In

some regions of the ocean depths, hydrothermal vents have been discovered. Here, chemolithotrophs serve as the primary producers, supporting rich communities of life in these habitats utterly devoid of sunlight.

Chemolithotrophs are unique in their ability to use reduced inorganic chemicals such as hydrogen sulfide (H_2S) and ammonia (NH_3) as a source of energy. These are the compounds produced as a result of anaerobic respiration, when inorganic molecules such as sulfate and nitrate serve as terminal electron acceptors. This is one important example of how nutrients are cycled; the waste products of one organism serve as an energy source for another.

Chemolithotrophs fall into four groups with respect to their energy source:

- (A) Hydrogen Bacteria: Oxidize hydrogen gas.
- (B) Sulphur Bacteria: Oxidize hydrogen sulfide.
- (C) Iron Bacteria: Oxidize reduced forms of iron.

TABLE 7

Chemolithotrophic Bacteria

Family Nitrobacteraceae	Oxidize ammonia or nitrite
<i>Nitrobacter</i>	Oxidize nitrite to nitrate
<i>Nitrospina</i>	
<i>Nitrococcus</i>	
<i>Nitrosomonas</i>	Oxidize ammonia to nitrite
<i>Nitrospira</i>	
<i>Nitrosococcus</i>	
<i>Nitrosolobus</i>	
Chemolithotrophic Sulphur Oxidizers	Oxidize sulphur and sulphur compounds
<i>Thiobacillus</i>	
<i>Sulfolobus</i>	
<i>Thiobacterium</i>	
<i>Macromonas</i>	
<i>Thiovulum</i>	
<i>Thiospira</i>	
Family Siderocapsaceae	Oxidize iron or manganese
<i>Siderocapsa</i>	Iron or manganese oxides deposited
<i>Naumanniella</i>	
<i>Ochrobium</i>	
<i>Siderococcus</i>	Iron but not manganese deposited

(D) Nitrifying Bacteria: include two groups of bacteria- one oxidizes ammonia, forming nitrate, and the other oxidizes nitrite, forming nitrate.

[Already discussed in chapter no. 6]

Chemolithotrophs derive energy in diverse and rather amazing way. In simple words, they remove electrons from inorganic substrates such as hydrogen gas, hydrogen sulfide, sulphur or iron and combine them with carbon dioxide and hydrogen. This reaction provides simple organic molecules and a modest amount of energy to drive the synthetic processes of the cell.

The chemolithotrophs extract electrons from an inorganic energy source and then use the electrons to generate ATP by oxidative phosphorylation. Molecular oxygen generally serves as the terminal electron acceptor. The amount of energy gained in metabolism depends on the energy source and the terminal electron acceptor.

ANOXYGENIC PHOTOTROPHIC BACTERIA

Plants, algae and cyanobacteria which carry out oxygenic photosynthesis use water as the source of electrons and produce oxygen as a product. The earliest photosynthesizing organisms were likely anoxygenic phototrophs. These use hydrogen sulfide or organic compounds rather than water as a source of electrons when making reducing power in the form of NADPH, and therefore they do not generate O_2 . They produce an oxidized organic compound or an oxidized form of sulphur, usually elemental sulphur (S) as an end product. Modern anoxygenic phototrophs are a phylogenetically diverse group of bacteria that inhabit a restricted ecological niche that provides adequate light penetration yet little or no O_2 ; most often, they are found in aquatic habitats such as bogs, lakes and the upper layer of muds.

The photosynthetic systems of the anoxygenic phototrophs are fundamentally different from those of plants, algae, and cyanobacteria. They have a unique type of chlorophyll called bacteriochlorophyll. This pigment absorbs wave lengths of light that penetrate to greater depths and are not used by other photosynthetic organisms. By producing elemental sulphur as a by-product of their photosynthesis, anoxygenic phototrophic bacteria probably caused the huge deposits of elemental sulphur that occur in various parts of the world. Certain lakes in North Africa are now to be in the process of forming new sulphur deposits. They contain large populations of anoxygenic phototrophs, and their bottoms are covered with elemental sulphur.

These bacteria are deeply coloured- red, orange, purple and bright green, because of the chlorophyll and accessory photosynthetic pigments they contain. Water samples from deep regions of lakes with an abundance of these organisms are also intensely colored.

Physiologically, these bacteria carry out photosynthesis anaerobically. The anaerobic photosynthetic bacteria typically occur in aquatic habitats, often growing at the sediment-water interface of shallow lakes where there is sufficient light penetration to permit photosynthetic activity, anaerobic conditions are sufficient to permit the existence of these organisms, and there is a source of reduced sulphur or organic compounds to act as electron donors for the generation of reduced coenzymes.

TABLE 8
Characteristics of the Major Groups of Phototrophic Bacteria

Metabolism	Taxonomic group	Photosynthetic pigments	Electron donors	Carbon source
Anoxygenic photosynthesis	Purple bacteria	Bacteriochlorophyll a or b, carotenoids	H ₂ , H ₂ S, S	Organic C or CO ₂
Anoxygenic photosynthesis	Green bacteria	Bacteriochlorophyll a or b, Carotenoids	H ₂ , H ₂ S, S	CO ₂
Oxygenic photosynthesis*	Cyanobacteria	Chlorophyll a, phycobiliproteins	H ₂ O	CO ₂
Oxygenic photosynthesis	Prochlorobacteria	Chlorophyll a + b, β-carotenes	H ₂ O	CO ₂
Purple membrane mediated	Halobacterium [†]	Bacteriorhodospin	—	Organic C

* Under some conditions, photosynthesis is anoxygenic, and H₂S serves as the electron donor.

[†] A nonautotrophic archaebacterium

The anoxygenic phototrophic bacteria include the Rhodospirillaceae (purple nonsulphur bacteria), Chromatiaceae (purple sulphur bacteria), Chlorobiaceae (green sulphur bacteria), and Chloroflexaceae (green flexibacteria).

Members of the family Chromatiaceae produce carotenoid pigments and may appear orange-brown, red-brown, purple-red, or purple-violet. They deposit elemental sulphur as a consequence of their utilization of reduced sulphur compounds as electron donors for generating reducing power. Because of their colour and sulphur metabolism, the Chromatiaceae are called the *purple sulphur bacteria*. In all but one genus of organisms within this large family, the sulphur accumulates intracellularly. Members of the Chromatiaceae are potentially mixotrophic, that is, they are capable of photoautotrophic and heterotrophic growth, and all strains are capable of photoassimilating simple organic substrates such as acetate. The cells of *Chromatium*, *Thiocystis*, *Thiosarcina*, *Thiospirillum* and *Thiocapsa* do not contain gas vacuoles, but some genera of the family Chromatiaceae, such as *Thiodictyon* and *Thiopedia*, do contain gas vacuoles that permit an adjustment of cell buoyancy in a water column to a depth appropriate for light intensity and oxygen concentration, making anaerobic photosynthetic metabolism possible.

The Chlorobiaceae produce green or green-brown carotenoid pigments and are obligately phototrophic. They assimilate carbon dioxide, utilizing sulfide or elemental sulphur as electron donors, and they deposit sulphur granules extracellularly. Because of their colour and sulphur metabolism, the Chlorobiaceae are called the *green sulphur bacteria*. All members of the Chlorobiaceae are nonmotile. These bacteria often occur in ecological situations similar to those of the Chromatiaceae.

The Rhodospirillaceae generally produce red-purple carotenoid pigments. Three genera are recognized : *Rhodospirillum* has spiral-shaped cells; *Rhodospseudomonas* has

spherical or rod-shaped cells that do not form filaments; and exhibit budding division. Members of the genera *Rhodospirillum* and *Rhodopseudomonas* are motile by means of polar flagella, whereas those of the genus *Rhodomicrobium* are peritrichously flagellated. Their photosynthetic development depends on the ability of the cells to photoassimilate simple organic compounds. When sulfide or thiosulfate is utilized as an electron donor, elemental sulphur is not deposited within the cell. The organic substrates utilized by the Rhodospirillaceae may serve as electron donors for generating reducing power or may be photoassimilated. Because they generally require preformed organic matter for growth and are able to utilize light energy for generating ATP, the type of metabolism they carry out is sometimes referred to as photoheterotrophic metabolism and the organisms are called the purple nonsulfur bacteria.

In the light under anaerobic conditions, typical members of the Rhodospirillaceae use molecular hydrogen or sulfide as an electron donor and can grow without organic compounds. As such, these organisms may be viewed as photoheterotrophs or as photoautotrophs, generally requiring organic growth factor compounds. Indeed, most strains in the Rhodospirillaceae require one or more vitamins. Clearly, the Rhodospirillaceae occupy a boundary position between autotrophs and heterotrophs. The basic metabolic pathways of the Rhodospirillaceae are the same as those of other autotrophic microorganisms. Their ability to assimilate organic compounds and the requirement of many members of the Rhodospirillaceae for such compounds establish the resemblance of these organisms to heterotrophs.

OXYGENIC PHOTOTROPHIC BACTERIA

Oxygenic photosynthetic bacteria are called oxyphotobacteria. Two orders are contained in this group of the oxygenic phototrophic bacteria. Cyanobacteriales and Prochlorales. Both of these orders occupy intermediate position between the phototrophic bacteria and the eukaryotic algae, indicating a probable evolutionary link to these higher photosynthetic organisms. The primary photosynthetic pigment in both cases is chlorophyll a, but prochlorophytes also possess chlorophyll b, making them very similar to the green algae. Presumably, the prochlorobacteria are more closely related to the green algae than are the cyanobacteria. Clearly, there is a phylogenetic relationship among the photosynthetic organisms, with the Oxyphotobacteria occupying an intermediate position between the Anoxyphotobacteria and the algae. Cyanobacteria, thought to be the earliest oxygenic phototrophs. These are photosynthetic organisms that use water as a source of electrons for reducing power, liberating O₂.

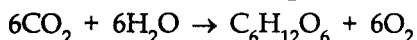

They are about the same size and shape as some algae, and they do produce oxygen as algae do. But cyanobacteria are prokaryotes. They have an outer membrane and a thin peptidoglycan wall typical of gram-negative bacteria.

Today cyanobacteria still play an essential role in the biosphere. As primary producers, they harvest the energy of sunlight, using it to convert CO₂ into organic compounds. They were initially thought to be a form of algae and were called blue green algae until electron microscopy revealed their prokaryotic structure.

THE CYANOBACTERIA

The cyanobacteria are a diverse group of more than 60 genera of gram-negative bacteria. They inhabit a wide range of environments, including fresh water and marine habitats, soils and the surfaces of rocks. Some cyanobacteria can fix atmospheric nitrogen. They obtain their carbon (as CO_2) as well as their nitrogen (as N_2) from the atmosphere. Cyanobacteria being photosynthetic, many are able to convert nitrogen gas (N_2) to ammonia, which can then be incorporated into cell material. In addition they need only a few minerals and a light source to grow. Cyanobacteria are the major nitrogen-fixers in nature.

CHARACTERISTIC FEATURES OF CYANOBACTERIA

Cyanobacteria are morphologically diverse. They are tough but flourish in almost all environments—oceans, lakes, streams and soil. Some genera are unicellular with typical prokaryotic shapes such as cocci, rods and spirals. Others form filamentous multicellular associations called trichomes, they may or may not be enclosed within a sheath, a tube that holds and surrounds a chain of cells. Motile trichomes glide as a unit. Cyanobacteria that inhabit aquatic environments often have gas vesicles, enabling them to move vertically within the water column. When large numbers of buoyant cyanobacteria accumulate in stagnant lakes or other fresh water habitats, they may form mats on the surface. In the bright, hot conditions of summer, these cells lyse and decay, creating an odiferous scum called a nuisance bloom.

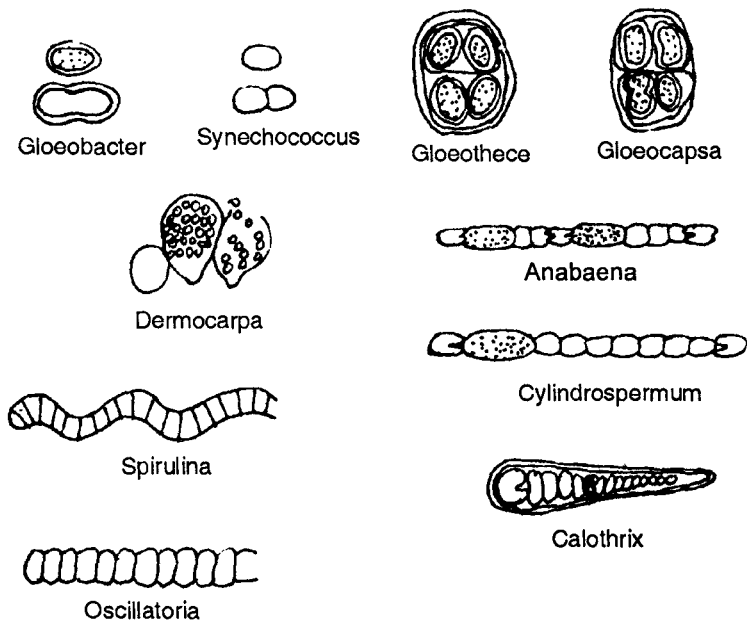

Fig. 6 : Cyanobacteria

The photosynthetic systems of the cyanobacteria are like those contained within the chloroplasts of algae and plants. In addition to light harvesting chlorophyll pigments, cyanobacteria have phycobiliproteins. These pigments absorb energy from wave lengths of light that are not well absorbed by chlorophyll. They contribute to the blue green algae, or sometimes reddish, colour of the cyanobacteria.

Nitrogen fixing Cyanobacteria

These bacteria are critically important ecologically. Because they can incorporate both N_2 and CO_2 into organic material, they generate a form of these organisms. Thus, their activities can ultimately support the growth of a wide range of organisms in environments that would otherwise be devoid of usable nitrogen and carbon.

Nitrogenase, the enzyme complex that mediates the process of nitrogen fixation, is destroyed by O_2 ; therefore, nitrogen fixing cyanobacteria must protect the enzyme from the O_2 they generate. Species of *Anabaena*, which are filamentous, isolate nitrogenase by confining the process of nitrogen fixation to a specialized thick walled cell called a 'heterocyst'. Heterocysts are not photosynthetic and, consequently, do not generate O_2 . The heterocysts of some species form at very regular intervals within the filaments, reflecting the ability of cells within a trichome to communicate.

One species of *Anabaena*, *A. azollae*, forms an intimate relationship with the water fern *Azolla*. The bacterium grows and fixes nitrogen within the protected environment of a special sac in the fern, providing *Azolla* with a source of available nitrogen. *Synechococcus* species, which are unicellular, fix nitrogen only in the dark. Consequently, nitrogen fixation and photosynthesis are temporally separated.

Filamentous cyanobacteria appear to be responsible for maintaining the structure and productivity of soils in cold desert areas such as the Colorado Plateau. Their sheaths persist in soil, creating a sticky fibrous network that prevents erosion. In addition these bacteria provide an important source of nitrogen and organic carbon in otherwise nutrient poor soils.

The Prochlorales

The prochlorales are similar to the cyanobacteria except that they also synthesize chlorophyll b. Although they originally were considered to be cyanobacteria, their unique ability as prokaryotes to produce chl. b is now considered significant enough to separate them into their own order. The only known genus, *Prochloron*, occurs as single celled, extracellular symbionts of marine invertebrates. These bacteria appear bright green on the surface of the animals with which they are associated. Various species of *Prochloron* have been recognized in field studies, but until the organisms are grown in pure culture, the validity of these species remains ambiguous.

THE PURPLE BACTERIA

The purple bacteria are a small group of gram-negative eubacteria. They are unicellular and reproduce by binary fission or, in a few species by budding. Most are motile by flagella; a few are immotile. Purple bacteria contain pigments on thylakoids, but they are different from the cyanobacteria in that they contain a special type of

chlorophyll called bacteriochlorophyll, they do not give off oxygen, and they live in habitats that lack oxygen. These bacteria are named for their predominant colors. They exist as single cells of many different shapes, and are frequently motile. These bacteria utilize sulphur compounds in their metabolism, and some may deposit intracellular granules of sulphur or sulfates. These organisms live in various aqueous habitats, including sulphur springs, fresh water lakes and swamps.

All purple bacteria are, at least potentially photoautotrophs, capable of growing anaerobically in the light with CO_2 as the carbon source and reduced inorganic compounds as the electron donor. Under these conditions, the Calvin-Benson cycle is the principal pathway of carbon assimilation. However, the purple bacteria can also develop photoheterotrophically under anaerobic conditions in the light at the expense of organic compounds, of which acetate is the most widely utilized.

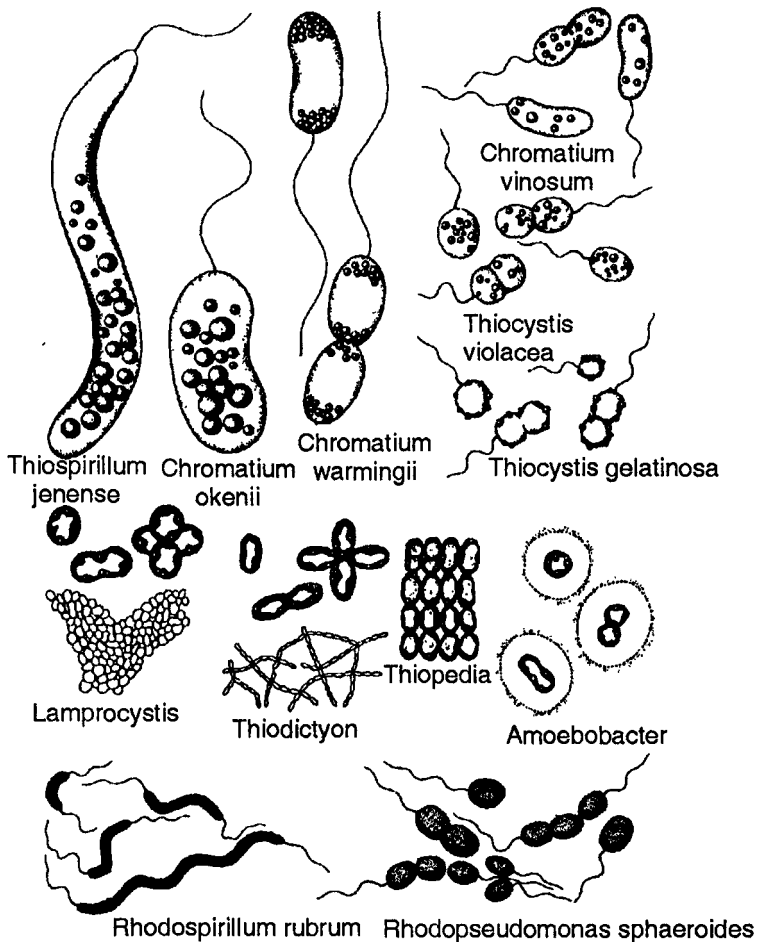

Fig. 7 : Sulphur purple and nonsulphur purple bacteria

TABLE 9
Characteristics that Distinguish the two Subgroups of Purple Bacteria

	Purple sulphur bacteria	Purple nonsulphur bacteria
Principal mode of photosynthesis	Photoautotrophic	Photoheterotrophic
Range of photoassimilable organic substrates	Narrow	Broad
Aerobic growth	- ¹	+ ¹
Ability to oxidize H ₂ S	+	+ ^{1,2}
Accumulation of S ⁰ as intermediate in H ₂ S oxidation to SO ₄ ²⁻	+	- ¹
H ₂ S toxicity	Usually low	Usually high
Percent G + C	45-70	61-72

¹ A few exceptions exist.

² Normally only at low concentrations.

The purple bacteria are gram negative organisms that appear red, orange or purple due to their light harvesting pigments. The components of their photosynthetic apparatus are all contained within the cytoplasmic membrane. Invaginations in this membrane effectively increase the surface area available for the photosynthetic processes. Purple bacteria are photosynthetic, they use light as a source of energy and carbon dioxide as their chief source of carbon.

Purple Sulphur Bacteria

Purple sulphur bacteria can sometimes be seen growing as colored masses in sulphur-rich habitats such as sulphur springs. The cells are relatively large, sometimes in excess of 5 µm in diameter, and some are motile by flagella. They may also have gas vesicles, which enable them to move up or down to their preferred level in the water column. The purple bacteria, such as *Chromatium*, also use sulphur, sulphur compounds or hydrogen gas to reduce carbon dioxide. They are distinguished from the green bacteria by their type of chlorophyll, location of stored sulphur and ribosomal RNA.

Many species of purple sulphur bacteria are strict anaerobes and phototrophs, but some can grow in absence of light aerobically, oxidizing reduced inorganic or organic compounds as a source of energy. Representative genera of purple sulphur bacteria include *Chromatium*, *Thiospirillum*, and *Thiodictyon*.

Purple Non-Sulphur Bacteria

The purple non-sulphur bacteria are found in a wide variety of aquatic habitats, including moist soils, bogs and swampy areas. One important characteristic that distinguishes them from the purple sulphur bacteria is that they preferentially use a variety of organic molecules rather than hydrogen sulfide as a source of electrons for reducing power. Purple non sulphur bacteria are remarkably versatile metabolically. Most purple

non-sulphur bacteria can grow aerobically in the absence of light using chemotrophic metabolism. Representative genera of purple non sulphur bacteria include *Rhodobacter* and *Rhodospseudomonas*.

TABLE 10
The Genera of Purple Sulphur Bacteria

Genus	Cell arrangement and shape	Motility	Gas Vacuoles	Site of sulphur deposition
<i>Thiospirillum</i>	Single; helical	+	—	Intracellular
<i>Ectothiorhodospira</i>	Single; vibroid	+	—	Extracellular
<i>Chromatium</i>	Single; cylindrical	+	—	Intracellular
<i>Thiocystis</i>	Single; spherical	+	—	Intracellular
<i>Thiocapsa</i>	Single or cubical packets; spherical	—	—	Intracellular
<i>Lamprocystis</i>	Single; spherical	+	+	Intracellular
<i>Thiodictyon</i>	Single or loose networks; cylindrical	—	+	Intracellular
<i>Thiopedia</i>	Flat rectangular plates; ovoid	—	+	Intracellular
<i>Amoebobacter</i>	Single; spherical	—	+	Intracellular

TABLE 11
The Genera of Purple Nonsulphur Bacteria

Genus	Cell shape	Flagellar insertion	Intracytoplasmic membranes	Prosthecae	Exospores	Mode of cell division
<i>Rhodospirillum</i>	Helical	Polar	Vesicular or Lamellar	—	—	Fission
<i>Rhodospseudomonas</i>	Rod	Polar	Lamellar	—	—	Budding directly from cell pole
<i>Rhodomicrobium</i>	Ovoid	Peritrichous	Lamellar	+	+	Budding from hyphal tip
<i>Rhodopila</i>	Cocoid or ovoid	Polar	Vesicular	—	—	Fission
<i>Rhodocyclus</i>	Curved rod	Polar or immotile	Tubular	—	—	Fission
<i>Rhodobacter</i>	Ovoid or rod	Polar or immotile	Vesicular	—	—	Fission

THE GREEN BACTERIA

The green bacteria are gram-negative organisms that are typically green or brownish in color. Unlike the purple bacteria, their accessory pigments are located in structures

called chlorosomes and their cytoplasmic membranes do not have extensive invaginations. The green bacteria such as *Chlorobium*, use sulphur (s), sulphur compounds or hydrogen gas to reduce carbon dioxide and form organic compounds. Applying the energy from light, and the appropriate enzymes, these bacteria oxidize sulfide (S^{2-}) or sulphur (S) to sulfate (SO_4^{2-}), or hydrogen gas to water (H_2O).

Most members of the green sulphur bacteria, are counter parts of the purple sulphur bacteria.

Green Sulphur Bacteria

Green sulphur bacteria use hydrogen sulfide as a source of electrons for reducing power and they form sulphur granules. These granules, however, form outside of the cell. The green sulphur bacteria lack flagella, but many have gas vesicles. All are strict anaerobes and none can use a chemotrophic metabolism. Representative genera include *Chlorobium* and *Pelodictyon*.

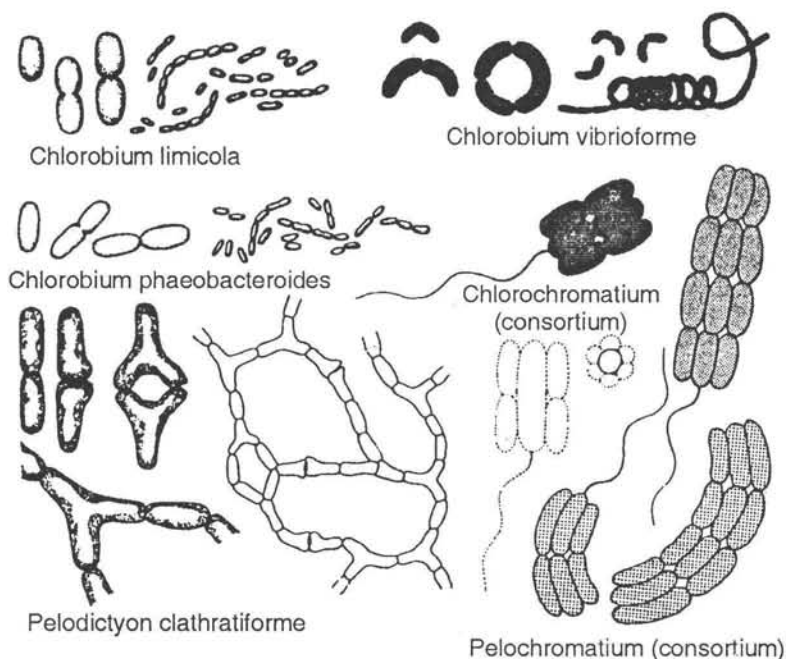

Fig. 8 : Phototrophic green sulphur bacteria (Chlorobiaceae)

Green Non-Sulphur Bacteria

These organisms are characterized by their filamentous growth. Metabolically, they resemble the purple non-sulphur bacteria, preferentially using organic compounds to generate reducing power. These bacteria can use hydrogen gas or hydrogen sulfide. They can grow in the dark aerobically using chemotrophic metabolism. *Chloroflexus* is the representative genus in this group.

TABLE 12
The Genera of Green Bacteria

	Cell form and arrangement	Gliding motility	Gas vacuoles	Prosthecae
Green sulphur bacteria	(G + C = 48 to 58 percent)			
<i>Chlorobium</i>	Straight or curved rods, single or short chains	—	—	—
<i>Prosthecochloris</i>	Ovoid, single or short chains	—	—	+
<i>Pelodictyon</i>	Chains of rods, forming nets	—	+	—
<i>Ancalochloris</i>	Spherical	—	+	+
<i>Chloroherpeton</i>	Unicellular filaments	+	—	—
Green nonsulphur bacteria	(G + C = 53 to 55 percent)			
<i>Chloroflexus</i>	Long filaments composed of rod-shaped cells	+	—	—
<i>Chloronema</i>	Long filaments composed of rod-shaped cells	+	+	—
<i>Oscillochloris</i>	Trichomes of discoidal cells	+	+	—

BUDDING BACTERIA

The appendaged bacteria are quite varied in their structure and life cycles, but all of them produce an extended process of the cell wall in the form of a bud, a stalk or a long thread. In some cases, the cellular extensions have a reproductive function, but in others they have a physiological purpose. Several budding bacteria, such as *Rhodomicrobium*, are associated primarily with other groups on the basis of their characteristic modes of nutrition. The stalked bacteria live attached to the surface of objects in aquatic environments. Budding is the term applied to the mode of multiplication that is characteristic for the budding yeasts. Contrary to binary fission, it is an unequal cell

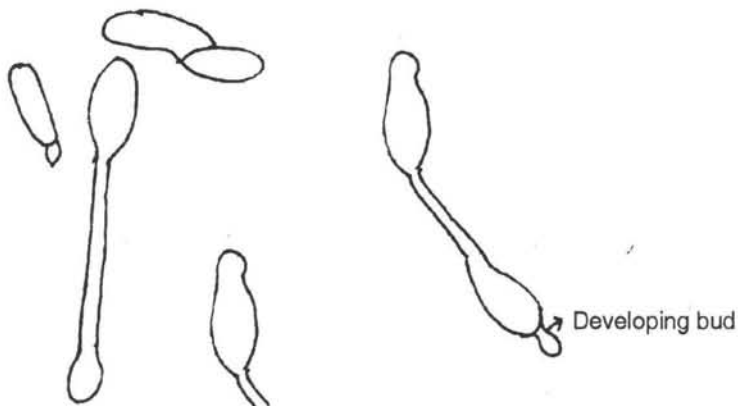

Fig. 9 : Type of budding bacteria

division which proceeds via localized growth. The daughter cell or bud is usually smaller than the mother cell and reaches normal size only after it has become separated from the mother cell. The bud breaks off, enlarges, develops a flagellum and swarms to another area to start its own cycle. These bacteria can also grow in very low nutrient habitats. One type can even grow in distilled water or tap water.

The budding and appendaged bacteria represent a heterogenous group on the basis of a particular morphological feature. In some cases, the cellular extensions have a reproductive function, but in others they have a physiological purpose.

Budding and appendaged bacteria occur in all nutritional categories. Members of the genus *Gallionella* are capable of chemolithotrophic metabolism; they are probably facultatively chemolithotrophic because they oxidize ferrous to ferric iron and fix carbon dioxide. *Gallionella* are sometimes considered to be sheathed bacteria because their 'stalks' may be covered with iron hydroxide. The growth of *Gallionella* species often causes problems in iron pipes of water delivery systems.

TABLE 13
Budding and Appendaged Bacteria

Description	Genus
Prosthecate bacteria	
Prosthecate with reproductive function; form new cells by budding	<i>Hyphomicrobium</i> <i>Hyphomonas</i> <i>Pedomicrobium</i> <i>Thiodendron</i>
Prosthecate with no reproductive function	<i>Caulobacter</i> <i>Asticcacaulis</i> <i>Ancalomicrobium</i> <i>Prosthecobacter</i> <i>Prosthecomicrobium</i> <i>Stella</i>
Nonprosthecate bacteria – Reproduce by budding	<i>Pasteuria</i> <i>Blastobacter</i> <i>Seliberia</i>
Bacteria with excreted appendages and holdfasts	
Reproduce by binary fission only	<i>Gallionella</i> <i>Nevskia</i>
Reproduce by budding	<i>Planctomyces</i>
Genera of uncertain affiliation	<i>Metallogenium</i> <i>Caulococcus</i> <i>Kusnezovia</i>

The cell appendages of the bacteria in this group, known as *prosthecae*, provide greater efficiency in concentrating available nutrients. Many of the appendaged bacteria grow well at low nutrient concentrations. The appendages provide sufficient membrane surface to transport adequate nutrients into the cell to support the metabolic requirements of the organism. Many of the bacteria in this group primarily occur in aquatic habitats where concentrations of organic matter typically are low. *Caulobacter*, for example, grows in very dilute concentrations of organic matter in lakes and even in distilled water. Its appendages are referred to as *stalks*. In some cases, the stalks of individual cells provide a *holdfast* by which the organisms can attach to a substrate. In other cases, stalks do not function in attachment but may permit cells to adhere to each other, forming rosettes.

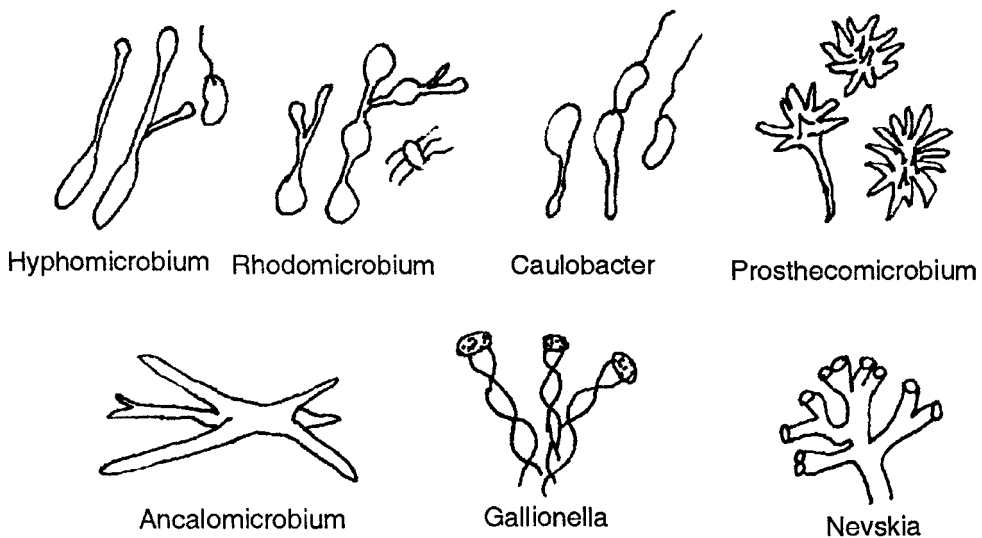

Fig. 10 : Prosthecate and stalked bacteria

Some of the appendaged bacteria form bizarre-looking cells. For example, members of the genus *Prosthecomicrobium* form prosthecae extending in all directions from the cell. *Seliberia* form radial clusters (star-like aggregates) of rod-shaped bacteria with a screw-like twisting of the rod surface and the formation of round reproductive cells by budding. At low nutrient concentrations, *Stella* forms flat cells resembling six-pronged stars. The isolation of various new types of appendaged bacteria has greatly increased our knowledge of the morphological diversity among the bacteria and the relationship between morphology and nutritional status. Many of the varied morphological forms of these bacteria are observed only at very low nutrient concentrations.

GRAM +ve BACTERIA

The Gram-positive bacteria can be divided into two groups : those that have a high G + C ratio, and those that have a low G + C ratio. To illustrate the variations in G + C ratio, the genus *Streptococcus* has a low G + C content of 33-34% and the genus *Clostridium* has a low content of 21-54%.

By contrast, filamentous actinomycetes of the genus *Streptomyces* have a high G + C content of 69-73%. Gram-positive bacteria of a more conventional morphology, such as the genera *Corynebacterium* and *Mycobacterium*, have, respectively, a G + C content of 51-63% and 62-70%.

The Gram-positive bacteria contain a number of anaerobic or facultatively anaerobic organisms, some of these are members of the actinomycete group, many of them are unicellular bacteria unrelated to the mycelial prokaryotes.

Many Gram positive bacteria share the ability to form a distinctive type of dormant cell known as an endospore. Endospores can be readily recognized microscopically by their intracellular site of formation, their extreme refractility, and their resistance to staining by basic aniline dyes that readily stain vegetative cells. They are not normally formed during active growth and division, their differentiation begins when a population of vegetative cells passes out of the exponential growth phase as a consequence of nutrient limitation.

MYCOBACTERIA

The mycobacteria are rod shaped, non-spore forming, aerobic bacteria that do not stain readily but, once stained, resist decolorization by acid or alcohol and are therefore called acid-fast bacilli. Mycobacteria are invariably aerobic. Morphologically they are intermediate between the corynebacteria and the proactinomycetes (*Nocardia*). They do not

form mycelia but grow in the form of irregularly shaped, slightly branched cells. They are non motile and gram-positive. One way in which they differ from corynebacteria is that they are 'acid fast'. Mycobacteria and nocardia are not decolourised by acid treatment and are designated 'acid fast'. A few saprophytic mycobacteria can be decolorized with HCl-alcohol, but not with aqueous HCl. The resistance to acid is due to the high levels of mycolic acid in the cell wall, which make the cells of mycobacteria waxlike and strongly hydrophobic. They usually contain granules and vacuoles, they do not form capsules, flagella or spores.

Most are strict aerobes that grow well on simple nutrients and media. Compared with other bacteria, the growth rate is generally slow, with generation times ranging from two hours to several days. Some members of the genus exhibit colonies containing yellow, orange or pink carotenoid pigments that require light for development, while others are non pigmented.

Worldwide, millions of people are afflicted with tuberculosis and leprosy; certain opportunistic species loosely grouped into a category called MOTT (Mycobacteria other than the tubercle bacillus) have become an increasing problem in immunosuppressed patients.

Corynebacterium, *Mycobacterium* and *Nocardia* exhibit a number of similar features in their cell wall composition, as well as differences. Their murein skeleton resembles that of the gram-negative bacteria, but it is complexed with an arabinogalactan, a polysaccharide consisting of arabinose and galactose. This is bound to lipids, namely, mycolic acids. Mycolic acids are branched hydroxyl acids ($R'-CHOH-CHR^2-COOH$) carrying aliphatic chain substituents in position 2 and 3.

MYCOBACTERIUM TUBERCULOSIS

The Tubercle Bacillus

Mycobacterium tuberculosis is the pathogen causing tuberculosis in human beings and was described by R. Koch in 1882, the *tubercle bacillus* is a long, thin rod that grows in sinuous masses or strands called cords. It produces no exotoxins or enzymes that contribute to infectiousness. Most strains contain complex waxes and a cord factor.

Culture of Mycobacterium

Simple synthetic media: Large inocula grow on simple media in several weeks. Small inocula fail to grow in such media because of the presence of minute amounts of toxic fatty acids. The toxic effect of fatty acids can be neutralized by animal serum or albumin, and the fatty acids may then actually promote growth. Activated charcoal aids growth.

Oleic acid-albumin media: May support the proliferation of small inocula, particularly if Tweens (water-soluble esters of fatty acids) are present (e.g. Dubos' medium). Ordinarily, mycobacteria grow in clumps or masses because of the hydrophobic character of the cell surface. Tweens wet the surface and thus permit dispersed growth in liquid media. Growth is often more rapid than on complex media.

Complex organic media: Small inocula, e.g., samples from patients, are grown on media containing complex organic substances, e.g. egg yolk, animal serum, tissue extracts. These media often contain penicillin or malachite green (e.g. Lowenstein-Jensen medium) to inhibit other bacteria.

Growth Characteristics

Mycobacteria are obligate aerobes and derive energy from the oxidation of many simple carbon compounds. Increased CO₂ tension enhances growth. Biochemical activities are not characteristic, and the growth rate is much slower than that of most bacteria. The doubling time of tubercle bacilli is 12 hours or more. Saprophytic forms tend to grow more rapidly, proliferate well at 22°C, produce more pigment, and be less acid-fast than pathogenic forms.

Response to Physical and Chemical Agents

Mycobacteria tend to be more resistant to chemical agents than other bacteria because of the hydrophobic nature of the cell surface and their clumped growth. Dyes (e.g. malachite green) or antibacterial agents (e.g. penicillin) that are bacteriostatic to other bacteria can be incorporated into media without inhibiting the growth of tubercle bacilli. Acids and alkalis permit the survival of some exposed tubercle bacilli and are used for concentration of clinical specimens and partial elimination of contaminating organisms. Tubercle bacilli are fairly resistant to drying and survive for long periods in dried sputum.

Variation: Variation can occur in colony appearance, pigmentation, cord factor production, virulence, optimal growth temperature, and many other cellular or growth characteristics.

TABLE 1
Pathogenicity of Mycobacteria

Species	Human	Guinea Pig	Fowl	Cattle
<i>M. tuberculosis</i>	+++	+++	-	-
<i>M. bovis</i>	+++	+++	-	+++
<i>M. kansasii</i>	+++	-	-	-
<i>M. avium-intracellulare</i>	+	-	+++	-
<i>M. fortuitum-chelonae</i>	+	-	-	-
<i>M. leprae</i>	++	-	-	-

PATHOGENICITY

There are marked differences in the ability of different mycobacteria to cause lesions in various host species.

Mycobacterium tuberculosis and *Mycobacterium bovis* are equally pathogenic for humans. The route of infection (respiratory versus intestinal) determines the pattern of lesions. In developed countries, *M. bovis* has become very rare. Some typical mycobacteria (e.g.

Mycobacterium kansasii) produce human disease indistinguishable from tuberculosis; others (e.g., *Mycobacterium fortuitum*) cause only surface lesions or act as opportunists.

Constituents of Tubercle bacilli

The constituents listed below are found largely in cell walls. Mycobacterial cell walls can induce delayed hypersensitivity, induce some resistance to infection, and replace whole mycobacterial cells in Freund's adjuvant. Mycobacterial cell contents only elicit delayed hypersensitivity reactions in previously sensitized animals.

Lipids: Mycobacteria are rich in lipids. Many complex lipids, fatty acids, and waxes have been isolated from them. In the cell the lipids are largely bound to proteins and polysaccharides. Some such complexes have been isolated. Lipids are probably responsible for most of the cellular tissue reactions to tubercle bacilli. Phosphatide fractions can produce tubercle like cellular responses and cause necrosis. Lipids are to some extent responsible for acid-fastness. When mycobacteria are defatted with ether, this staining property is lost. Analysis of the lipids by gas chromatography can reveal species-specific patterns that aid in classification.

Virulent strains of tubercle bacilli form microscopic serpentine cords in which acid-fast bacilli are arranged in parallel chains. Cord formation is correlated with virulence. A cord factor (trehalose-6, 6'-dimycolate) has been extracted from virulent bacilli with petroleum ether. It inhibits migration of leukocytes, causes chronic granulomas, and can serve as an immunologic adjuvant.

Proteins: Each type of *Mycobacterium* contains several proteins that elicit the tuberculin reaction. Proteins bound to a wax fraction can, upon injection, induce tuberculin sensitivity. They can also elicit the formation of a variety of antibodies.

Polysaccharides: *Mycobacteria* contain a variety of polysaccharides. Their role in the pathogenesis of disease is uncertain. They can induce the immediate type of hypersensitivity and can interfere with some antigen-antibody reactions *in vitro*.

Pathogenesis

Mycobacteria produce no recognized toxins. Organisms in droplets of 1-5 μm are inhaled and reach alveoli. The disease results from establishment and proliferation of virulent organisms and interactions with the host. Virulent bacilli (e.g. BCG) survive only for months or years in the normal host. Resistance and hypersensitivity of the host greatly influence the development of the disease.

Pathology: The production and development of lesions

Other Mycobacteria

In addition to tubercle bacilli (*M tuberculosis*, *M bovis*), other *Mycobacteria* of varying degrees of pathogenicity have been grown from human sources in past decades. These atypical mycobacteria were initially grouped according to speed of growth at various temperatures and production of pigments.

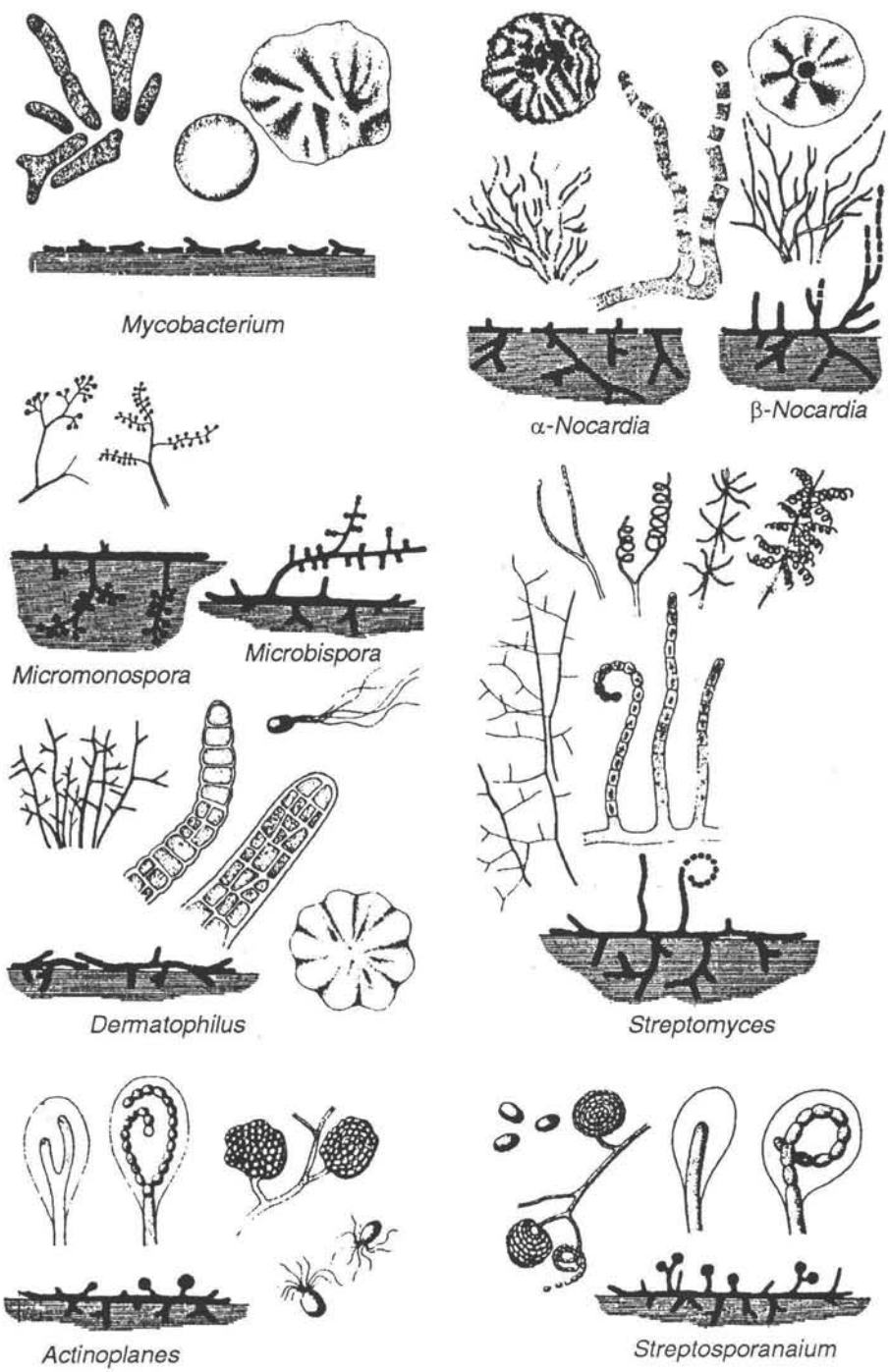

Fig. 1 : Mycobacteria, Nocardia and Actinomyces

A few species or complexes that are significant in medicine are outlined below:

***Mycobacterium kansasii*:** *M. kansasii* is a photochromogen that requires complex media for growth at 37°C. It can produce pulmonary and systemic disease indistinguishable from tuberculosis, especially in patients with impaired immune responses. Sensitive to rifampin, it is often treated with rifampin + ethambutol + INH with good clinical response. The source of infection is uncertain, and communicability is low or absent.

***Mycobacterium avium-intracellular* complex:** The members of this group grow optimally at 41°C and produce smooth, soft colonies with little colour. Able to infect birds, they cause spontaneous human disease infrequently. Infection with *M. intracellular*, however, is common in the southeastern USA, where the organisms occurs in soil and water, and results in skin test reactions to PPD-B. Overt pulmonary disease occurs mainly in immuno-deficient persons. Resistance to antituberculosis drugs is common, and disease due to this organism requires treatment with rifampin + ethambutol + streptomycin or cycloserine for many months.

***Mycobacterium scrofulaceum*:** This is a scotochromogen, occasionally found in water and as a saprophyte in adults with chronic lung disease. It is the commonest cause of chronic cervical lymphadenitis in small children and rarely causes other granulomatous disease. Surgical excision of involved cervical lymphadenitis in small children and rarely causes other granulomatous disease. Surgical excision of involved cervical lymph nodes may be curative, whereas resistance to antituberculosis drugs is common. Occasionally, infection responds to combined treatment with INH + rifampin + streptomycin or cycloserine.

***Mycobacterium marinum* and *Mycobacterium ulcerans*:** These organisms occur in water, grow best at low temperature (31°C), may infect fish, and can produce superficial skin lesions (ulcers, swimming pool granulomas) in humans. Surgical excision, tetracyclines, and antituberculosis drugs may be tried in therapy. *Mycobacterium fortuitum-chelonei* **Complex:** These are saprophytes found in soil and water that grow very rapidly *in vitro* and form no pigment. They can produce superficial and systemic disease in humans on rare occasions. *M. chelonei* has contaminated porcine valves used as prostheses in human cardiac surgery. The organisms are often resistant to commonly used drugs but may be susceptible to amikacin or doxycycline.

ENDOSPORE FORMING RODS AND COCCI

The ability to produce more or less heat resistant spores is restricted to a group of gram + ve, motile rods with peritrichous flagella.

- Aerobic and facultatively anaerobic rods belong to the genera. *Bacillus*, *Sporolactobacillus* and *Sporosarcina* and the anaerobic rods belong to the genera *Clostridium* and *Desulfotomaculum*.
- **Aerobic spore formers:** The aerobic spore formers live in soil. Many bacilli form chains or filaments. They can be differentiated into the following groups according to the shape of their spores and vegetative cells.

(I) The spores of the majority of bacilli are oval or cylindrical in shape and no wider

than the vegetative cells (*Bacillus megaterium*, *B. cereus*, *B. subtilis*, *B. licheniformis*, *B. anthracis*, *B. thuringiensis*).

(II) The oval spores are wider than the vegetative cells, during sporulation the cells become distended (*B. polymyxa*, *B. macerans*, *B. stearothermophilus*, *B. circulans*).

(III) Almost spherical spores in terminally distended vegetative cells (*B. pasteurii*).

***B. megaterium*:** With dimensions of $2 \times 5 \mu\text{m}$ giant among rod shaped eubacteria. *B. cereus* is somewhat smaller. *B. anthracis* which is non-flagellated and surrounded by a capsule containing glutamic acid. *B. thuringiensis* is also related. *B. subtilis* is called hay bacterium because it is easily isolated from hay by enrichment culture, *B. licheniformis* produce polypeptide antibiotics.

B. polymyxa (formerly called *B. asterosporus*) takes its name from its profuse slime production and the star-shaped cross section of its barrel shaped spores. It produces 2, 3- butane diol as does *B. licheniformis*. *B. stearothermophilus* is a thermophilic organism with an optimum growth temperature of 50-65°C.

(III) *B. pasteurii* is known as classic urea-degrading organism, it produces urease constitutively, hydrolyses urea to CO_2 and NH_3 and is adapted to grow at high pH values.

Anaerobic Spore Formers

They do not need O_2 for growth *Clostridium* usually lack cytochromes and catalase most clostridia contain high levels of flavin enzymes and on contact with air or oxygen, they form H_2O_2 which is toxic to these cells. Spore forming, sulphate reducing bacteria, once included with the clostridia have been placed in new genus *Desulfotomaculum* (*nigrificans*, *orientis*, *ruminis*) because they contain protohaem like pigments.

The clostridia can ferment a large number of substrates, including polysaccharides, proteins, $-\text{NH}_2$ acids and purines. They can be differentiated according to their preferred substrates into *C. butyricum*, *C. acetobutylicum* pepto-clostridia (*C. histolyticum*, *C. sporogenes*, *C. tetani*, *C. botulinum*) and uric acid-degrading clostridia (*C. acidi-urici*). Their fermentation products are butyrate butanol, acetone, 2- propanol and large quantity of gas (CO_2 and H_2).

Bacillus

- Consist of aerobic bacilli forming heat resistant spores.
- Gram + ve but tend to decolourise easily so it appears gram variable.
- Generally motile with peritrichous flagella.
- Genus includes psychrophilic, mesophilic and thermophilic spp.
- Spores are ubiquitous and constitute the commonest contaminants in bacteriological culture media.
- *Bacillus anthracis* (causative agent of anthrax is the major pathogenic sps).
- *B. cereus* causes foodborne gastroenteritis.
- *B. anthracis* was the first pathogenic bacterium to be observed under the microscope (Pollender, 1849), the 1st communicable disease shown to be

transmitted by inoculation of infected blood (Davaine, 1950). And the 1st bacilli to be isolated in pure cultures and shown to possess spores (Koch, 1876).

- The bacilli is one of the largest of pathogenic bacteria measuring 3-10 x 1-1.6 μm found singly, in pairs or short chains and entire chain being surrounded by a capsule.
- Capsule is polypeptide in nature, composed of a polymer of d(-) glutamic acid. Capsule are formed only if the media contain added bicarbonate or are incubated under 10-25% of CO_2 .
- In cultures the bacilli are arranged end to end in long chains and the ends are truncated or often concave and some what swollen so that a chain of bacilli presents a 'bamboo stick' appearance.
- Spores are formed in soil or culture but never in animal body during life. Spores are elliptical or oval in shape.
- M. fadyean's reaction is employed for presumptive diagnosis of anthrax in animals.
- Aerobe and facultative aerobe optimum temperature 35-37°C (25-30°C for sporulation).
- On solid media (agar plate) irregularly round colonies 2-3 mm in diameter, raised, dull, opaque, greyish white with frosted glass appearance and gives medusa head appearance (long interlacing chains of bacilli resembling locks of matted hair).

Anthrax is primarily a disease of cattle and sheep and less often of horses and swine.

Anthrax toxin is a complex of three fractions. (i) the edema factor (EF or Factor I) (ii) Protective antigen factor (PA or factor II) and (iii) Lethal factor (LF or Factor III) they are not toxic individually but the whole complex produces local edema and generalized shock.

(Anthrax = means coal, comes from black colour of eschar) lesion is called "Malignant Pustule". Anthrax is a zoonosis. Animals are infected by ingestion of spores present in the soil. The disease is generally a fatal septicemia but may sometimes be localized, resembling the cutaneous disease in human beings.

Human anthrax is contracted from animals directly or indirectly.

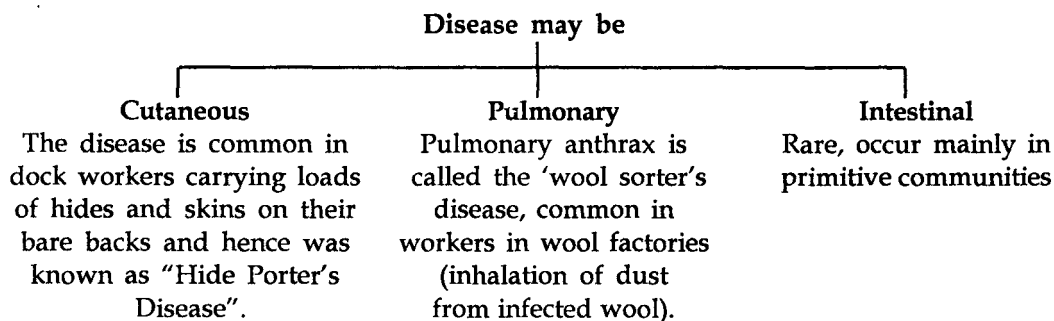

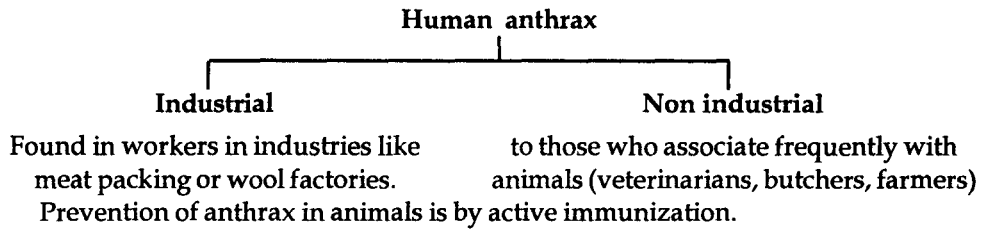

Clostridium

Consists of Gram + ve, anaerobic, spore forming bacilli. The spores are wider than bacillary bodies giving the bacillus a swollen appearance resembling a spindle. Hence the name Clostridium (kloster = spindle). The genus is responsible for three major diseases of human beings—gas gangrene, food poisoning, tetanus.

Many sps are pathogenic but most are saprophytic found in soil, water and decomposing plants and animals. Some *C. acetobutylicum* are used for the production of acetone and butanol.

- They are highly pleomorphic, rod shaped 3-8 μm \times 0.4-1.2 μm long filaments and involution are common. Some sporulate readily while other do rarely. The shape and position of spores are used for identification and classification of clostridia.

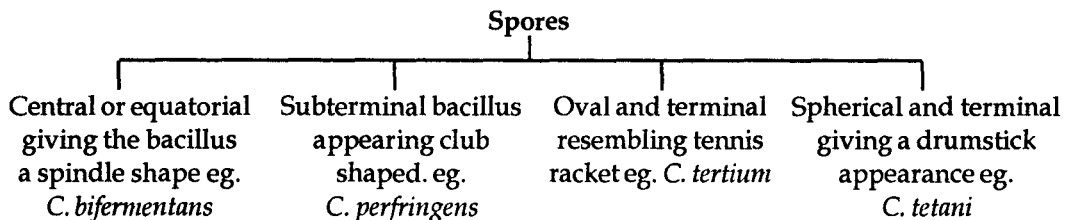

- They are motile with peritrichous flagella.
- Gram + ve but older stain is gram variable (gram-ve)
- Anaerobic optimum temperature is 37°C (some thermophilic others psychrophilic) optimum pH = 7-7.4
- Pathogenic *Clostridia* form powerful exotoxins. *C. botulinum* causing botulism is due to ingestion of performed toxin in food. *C. tetani* causing tetanus results from the action of potent exotoxin it produces.

***C. tetani*:** The causative organism of tetanus has been known from very early times being described by Hippocrates and Aretaeus. Rosenbach (1886) demonstrated a slender bacillus with round terminal spores in case of tetanus. The final proof of etiological role of bacillus was furnished by Kitasato (1889).

It is widely distributed in soil and intestine of human beings and animals.

- Obligate anaerobe
- It produces at least two distinct toxin.

- (a) Haemolysin (tetanolysin)—heat O₂ labile
- (b) Neurotoxin (tetanospasmin)—responsible for tetanus

Incubation period is 6-12 days. It is a very serious disease with a high rate of mortality (80-90%). It is very common in developing countries where climate is warm and rural areas where soil is fertile and highly cultivated (where human and animal population lives in close association and unhygienic practices are common).

- Prevention is by active immunization.
- C. botulinum* was 1st isolated by Van Ermengem (1896)
- 8 types of *C. botulinum* have been identified (Type A,B,C1,C2,D,E,F,G) based on immunological difference in the toxins produced by them).
 - They produce powerful exotoxin responsible for pathogenicity and it is not released during the life of the organism, produced intracellularly and appears in the medium only on the death and autolysis of the cell.
 - *C. difficile* is not found to be responsible for antibiotic associated colitis by the production of an enterotoxin as well as cytotoxin.

ACTINOMYCETES

Actinomycetes was first discovered by Ferdinand Cohn in 1875 and it was first named as Actinomyces by Harz in 1877. It was first recognized by Gasperini in 1890 as potential destroyers of bacteria and fungi. Morphologically, actinomycetes fall between fungi and bacteria (mould like bacteria). In many respects they resemble fungi, and for that reason they are known as ray fungi. Their filamentous nature, branching pattern, and conidia formation are similar to those of fungi. Their size and spore characters are similar to bacteria. Recent detailed studies have brought out clearly that actinomycetes are quite distinct from the fungi and bacteria in many respects. Their natural occurrence is mostly restricted to soils. They are gram + ve and are related to the coryneform bacteria and mycobacteria by an almost continuous sequence of intermediate form. The actinomycete colonies are characteristic in several respects. They produce mass of growth to form a colony, but an actinomycete colony differs from the bacterial colony in that it consists of a mass of filamentous threads with spore-bearing hyphae. They consist of vegetative and sporogenous hyphae. The vegetative mycelium is lichoid and exists below the surface of the agar medium. The colour of the vegetative mycelium may vary, and it may also produce soluble pigments in the medium.

The aerial mycelium emerges from the vegetative hyphae in the medium. The type of aerial mycelium varies with the genus and species of the actinomycetes. The chief characteristics of spore-bearing hyphae are illustrated. The sporogenous hyphae vary in length and may be formed in chains, whorls, tufts, or in spring. The method of branching of the hyphae also is characteristic of the species, and serves as a basis for speciation of Streptomyces. Actinomycetes produce true conidia or chlamydospores. Due to segmentation of old hyphae, cylindrical spores are produced. In the case of sporulation, electron microscopic studies have revealed that the spores are formed within the hyphal wall, the hyphal contents divide simultaneously to form separate dense particles, which

are transformed into chains. In some species the hyphal wall persists in the form of a sheath, even after the liberation of the spores. The spores may be spherical, oval or cylindrical. On germination of the spores, formation of one or two germ tubes has been reported. From the germ tubes primary hyphae are formed, which give rise to a network of thin mycelium. In the substrate the mycelium is thin, vegetative, and of varying colour. The growth of actinomycetes on solid or liquid medium results in characteristic colonies or masses. The cells can be readily stained with methyl-violet, carbol-fuchsin or methylene-blue. They are mainly gram-positive and the acid fastness varies with the genera. In some species club formation, which is similar to capsule formation in bacteria, has been reported. A few species of actinomycetes have been reported to be motile, but the presence of flagella has not been conclusively proved.

Actinophages have been isolated and shown to be specific pathogens for streptomyces. They resemble bacteriophages in most respects. For this reason, actinomycetes are believed to be closer to bacteria than fungi.

Nocardia generally forms small circular transparent glistening colonies on gelatin, and round, curved, slightly arborescent or pink colonies on agar media. Aerial mycelium is colourless and irregular. *Actinomyces spp.* show scanty growth in gelatin, whereas *Streptomyces spp.* produce grey colonies, sometime with soluble pigmentation. Some streptomycetes produce punctiform colonies with white aerial mycelium.

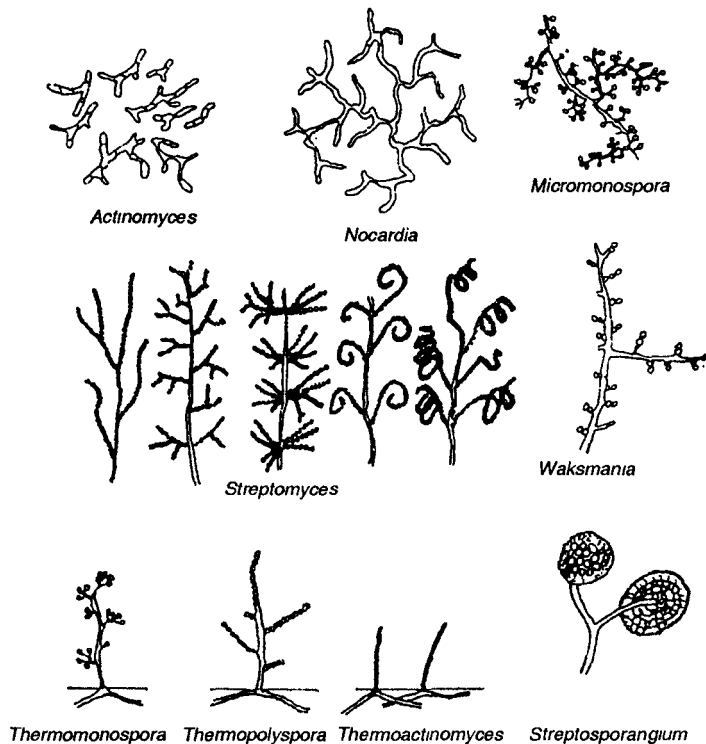

Fig. 2 : Some actinomycetes showing spore bearing hyphae

Nocardias are peculiar in their rapid segmentation of the mycelium into irregularly shaped cells, filaments, rods or cocci. This polymorphism has caused considerable confusion in the taxonomic literature. In some cases they multiply by budding to produce colonies similar to those of micrococci. The concentration and segmentation of the protoplasm in the filaments is commonly observed. In some older cultures, chlamydospores are also seen. Some nocardias exhibit motility at certain stages of their growth. When stained, young nocardias show undifferentiated protoplasm. The conidia are produced singly at the end of simple or branched conidiophores. Sporangiospores are borne inside the hyphal strands, and they are usually spherical in shape. The cell wall substance is neither chitin nor cellulose and it is not resistant to desiccation unlike in streptomycetes.

Actinomyces spp. are pathogenic in many instances, and are anaerobic or microaerophilic. They branch in a characteristic angular manner. Their colonies are tough and sometimes diptheroid.

Streptomycetes are mostly aerobic and soil-dwellers, except for a few plant pathogenic species. Many streptomycetes degrade cellulose, chitin and other recalcitrant natural substances. The vegetative mycelium usually does not fragment into bacillary or coccoid cells whereas conidia are borne in sporophores. Typical aerial mycelium is much branched, and the conidia are formed in chains. The conidia formation patterns broadly divided into five groups, viz. (a) straight sporulating hyphae. (b) spore-bearing hyphae arranged in clusters, (c) spiral formation in aerial mycelium with long and open spirals (d) spiral formation of the aerial mycelium, short and compact, and (e) spore-bearing hyphae arranged on the mycelium in whorls or tufts. In some cases the capacity to produce conidia and aerial mycelium may be lost due to continued culturing in artificial media.

Micromonospora spp. are non-septate and thin. They do not form aerial mycelium but spread well inside the agar medium. The substrate hyphae are branched with cross-walls and the aerial mycelium is either not formed or rudimentary. They multiply by conidia formation, either singly at the end of special conidiophores, which may be branched, or in clusters.

The genus *Waksmania (Microbispora)* is characterized by the formation of spores in pairs on aerial conidiophores. The mycelium may be substrate or aerial, and the aerial mycelium bears spores which are formed in longitudinal pairs. There are four genera which comprise the thermophilic group of actinomycetes. They are: (i) *Thermomonospora* which has long aerial hyphae, forming spores singly on simple or branched sporophores; (ii) *Thermopolyspora* which has long hyphae with spores produced in pairs or long chains; (iii) *Thermoactinomyces* which has spores singly or in chains, originating directly from the substrate mycelium. This is thermophilic and occurs as part of the bacterial flora of damp haystacks and piles of organic waste where heat is generated. Their spore resemble the endospore of *Bacillus* and *Clostridium*. (iv) *Pseudonocardia* which has septate substrate mycelium, with spores formed from both aerial and substrate mycelium. Some species of *Streptomyces* are also thermophilic and are grouped among the above four genera. Two other genera of actinomycetes which are less commonly known are: (1) *Actinoplanes* which have no aerial mycelium, but produce motile sporangiospores inside sporangial bodies, and (2) *Streptosporangium* which has aerial mycelium with coiled sporangiophores and

non-motile sporangiospores formed inside sporangial bodies. There are also several other incompletely described morphological forms of actinomycetes.

It is easy to differentiate primary and secondary mycelia under the micro-scope: secondary mycelium is thicker and darker in colour; their cells are roughly of the same thickness as bacteria, i.e. 0.6 to 1.8 μm . The division is also bacteria-like in most cases. The cell wall is also gram-positive and some are acid-fast, and the wall is composed of mucopolysaccharides, together with 2 percent lipid, whereas fungi contain chitin, cellulose and lignin. Thus, cytologically actinomycetes resemble bacteria.

The carbon content (45%) of the actinomycetes cell is not much different from that of fungi and bacteria. Actinomycetes have a nitrogen content of 10%, which is more than that of fungi, and are closer to bacteria. The amino acid content of actinomycetes and bacteria is almost similar. The work on the mycobacteria has shown that 63% of lipid is present in the cell. In other actinomycetes, the aerial mycelium contains more lipid than the primary or vegetative mycelium. *Streptomyces griseus* contains 14% lipid, as against 4.4 % in *Bacillus subtilis*. Cellulose and chitin are absent in *Streptomyces*.

When treated with 30% KOH, the cell wall of actinomycetes disappears. If cellulose and chitin are present, they are not soluble in 30% KOH. Lysozyme, which is specific for mucopolysaccharides, can lyse the cell wall of actinomycetes. Besides, hexosamine has been detected in the cell wall of *Streptomyces* spp. *S. fradiae* and *S. griseus* contain 18.48 % and 19.9% hexosamine, respectively, as against 2 to 3 % in *Nocardia* spp. There is most of hexose in *Nocardia* than in *Streptomyces*. The protein contents of *Streptomyces* and *Nocardia* have been studied and found to be similar. Arginine, lysine, hexosamine, alanine, valine, methionine, leucine, isoleucine, threonine, glutamic acid, diaminopimelic acid, asparagines, etc are the common amino acids found in these proteins.

The dry powdery appearance of the aerial mycelium of actinomycetes, and the difficulty of wetting the spores appears to be due to the presence of lipids in their cell walls. In 1954 O.T. Avery and F. Blank reported that representative species of *Actinomyces*, *Nocardia*, *Streptomyces* and *Micromonospora* were all devoid of chitin and cellulose, and this is indicative of their closer relationship to bacteria than to fungi. Though several scientists attempted to demonstrate the presence of nucleus in actinomycete cells, the first convincing account came from L. Grigorakis who in 1931 found that in the thallus of *Actinomyces bovis*, the nuclei divided amitotically, whereas in the aerial spores nucleus could not be demonstrated. By the Feulgen test some scientists found diffused staining of granules in the cells of actinomycetes. Some evidence for the presence of discrete nuclei in the spore-bearing mycelium and in conidia has been obtained.

Studies on the cell constituents have indicated the presence of several substances of serological specificity. Diaminopimelic acid derivative and glycogen, manopyranose, arbofuranose, amino sugars, rhamnopyranose, etc and fat bodies have been reported in the young mycelia of *Nocardia*, *Streptomyces* and *Micromonospora*. Several known fatty acids and a new one, named nocardic acid in *Nocardia asteroides*, have been studied. Presence of vacuoles are commonly found. Volutin and fat globules are also found.

The proponents of two-phase cycle in actinomycetes postulate a haploid substratal

mycelium and diploid aerial mycelium. The presence of certain more or less spherical structures, believed to be nuclei, has been shown in electron microscopic investigations of *Streptomyces griseus*. Both nuclear fusion and reduction division are believed to take place before vegetative growth sets in. Several workers have also observed irregular distribution of nuclear material in the cell cytoplasm, more than two nuclei in each cell, irregular septation of the mycelium resulting in multinucleate or uninucleate cells, etc.

Actinomycosis

Actinomycosis may be defined as the disease caused by Actinomycetes. It has been reported that generally the most affected sites of the body are lungs, jaws and intestine.

The actinomycosis is a chronic pus forming disease caused by the microorganism of the group actinomycetes. The disease spreads to surrounding tissue no matter of what type the tissue may be that means there exists no limitation of anatomical barriers. There may be a rare hematogenous spread followed by the formation of sinus (enormously expanded vein) tracts that drains suppurative lesions. The granulomatous tumours are formed which usually suppurate discharging a thick, oily pus containing yellowish granules (sulphur granules).

TABLE 2
Comparison of Actinomycetes and Moulds

Actinomycetes	Moulds (Eumycotina)
1. Represent prokaryotic structure.	These are eukaryotic.
2. The filaments of actinomycetes are minute, 1 to 5 μm in diameter and never more than a few mm in length.	Hyphae 10-20 μm in diameter and their mycelia are generally several inches in length.
3. The cell wall of actinomycetes possess peptidoglycan like bacteria and contain both muramic acid and diamino-pimellic acids which are found only in bacteria.	Cell wall is chitinous.
4. Sexual reproduction absent.	Sexual reproduction by sex organs in many true moulds, is seen.
5. They are true branching bacteria.	They are true filamentous fungi.

BIOTECHNOLOGICAL POTENTIAL OF ACTINOMYCETES

Actinomycetes have been most widely attracted group of microorganisms and to be exploited in terms of biotechnological applications. Actinomycetes have provided many important bioactive compounds of commercial value and continue to be routinely screened for new bioactive compounds. These searches have been remarkably successful and approximately two thirds of naturally occurring antibiotics including many of medical important have been isolated from actinomycetes.

All over the world scientists screening actinomycetes at various levels for the discovery of high value metabolites because of the following major reasons:

- Excellent tract record
- Chemical diversity
- Chemical surprise
- Inherent biological activity

Accessing microbial biosynthetic diversity has historically involved the isolation and cultivation of chemically prolific taxa, of those now recognized as such bacteria with in the order actinomycetales. The value of actinomycetes to society in terms of providing useful drugs, especially antibiotics and anticancer agents and to the pharmaceutical industry for revenue generating discovery platform, is indisputable. Actinomycete compounds or derivatives there of accounted for approximately two thirds of the naturally occurring antibiotics as of 1988, making them one of the single most important sources of prescription drugs. These bacteria, which are best known from soils, have been the focus of aggressive research efforts since the discovery of actinomycin in 1940 from *Actinomyces antibioticus* by Selman Waksman at Rutgers University. Additional actinomycete products such as antibiotics like streptomycin and novobiocin and firmly cemented these chemically prolific bacteria in the centre stage of natural products drug discovery research (Jenson *et al.*, 2003).

So many high value metabolites (both primary and secondary metabolites) of commercial importance have been produced by cultivation of members of this group for the past 50-60 years and new compounds are discovered, patented and marketed every year. A search for recent literature revealed that at least 4,607 patents have been issued on actinomycete related products and processes (Labeda and Shearer, 1990). Out of 22,500 total bioactive secondary metabolites 10,100 (45%) are reported to produced from actinomycetes (7630 from Streptomycetes and 2470 from rare actinomycetes). The number of bioactive compounds produced from common actinomycetes and the group of compound produced are presented in table 3 & 4.

TABLE 3
Number of Bioactive Compounds Produced from Common Actinomycetes

Genus	1974	1980	1984	1988	1992	1996	2005
<i>Streptomyces</i>	1934	2784	3477	4877	5645	6600	7630
<i>Micromonospora</i>	41	129	269	398	492	535	740
<i>Actinomadura</i>	0	16	51	164	248	315	345
<i>Streptoverticillium</i>	19	41	64	168	169	244	258
<i>Nocardia</i>	45	74	107	262	270	287	357
<i>Actinoplanes</i>	6	40	95	146	169	195	248
<i>Streptosporangium</i>	7	20	26	39	57	66	79

TABLE 4
Major Groups of Bioactive Secondary Metabolites

Type of activity	Actinomycetes	Fungi	Other bacteria	Total
Pharmacologically/				
Immunologically active agents	230	750	80	1060
Enzyme inhibitors	380	150	40	570
Phytotoxins/Herbicides	80	380	50	510
Pesticides	360	85	10	455
Microbial regulators	30	30	20	80
Other active agents	320	2305	700	3325
Total number	1400	3700	900	6000
Antibiotics	8700	4900	2900	16,500
Bioactive microbial secondary metabolites (total)	10100	8600	3800	22,500

The secondary metabolites produced by actinomycetes possess different kinds of activity. The secondary metabolites are very complex in structure it needs so many enzymes for its synthesis. For example nearly 30 different enzymes are involved in the synthesis of the antibiotic streptomycin. Such kind of complex synthesis is not easy to carry out chemically and another important point is a single secondary metabolite may exhibit different activity. Avermectin-a secondary metabolite produced by *Streptomyces avermetilis* which showed antibacterial, antifungal, antiparasitic and insecticidal activity. Another example is the ascomycin was reported in 1962 as an antifungal antibiotic produced by *S. hygroscopicus* var. *ascomyceticus*. The later study showed that this culture produces immunosuppressive activity and further analysis revealed that ascomycin is composed of two compounds that is FR900520 and FR900523, related to the immunosuppressive FK506 (Hatanaka *et al.*, 1988) which is produced by *Streptomyces tsukubaensis*. This kind of surprising activity exhibited by actinomycete compounds is one of the reasons for the standing of actinomycetes among the various kinds of industrial important microorganisms.

Antibiotics from Actinomycetes

Secondary metabolism and secondary metabolite production is a parental character of actinomycetes which are produced at the end of the stationary phase (idiophase) and are not necessary for the growth of actinomycetes. Antibiotic is one of the major secondary metabolite produced by most actinomycetes which confers the antagonistic properties to it. The antibiotics include antibacterial, antifungal, antiparasitic and antihelminthic agents. Most actinomycetes produce chemically diverse group of bioactive compounds including antibiotics with inherent biological activity. It is difficult to produce which genera of actinomycete produce specific chemical group of antibiotics. Another important point to remember is the antibiotic (secondary metabolite) production is not a genus or

species specific, it is strictly a strain 5 specific process. But if one is interested in specific class of compounds, it is useful to have some background knowledge which is produced by strains of specific genera (Table 5). But it is not true in all the cases (Labeda and Shearer, 1990). A novel antiviral agent, fattiviracin FV-8, purified from the culture broth of *streptomyces microflavus* strain No. 2445, was reported to have potent antiviral activities against human immunodeficiency virus type 1 (HIV-1), herpes simplex virus type 1 (HSV-1) varicella-zoster virus (VZV), and influenza A and B viruses (Habib *et al.*, 2001).

TABLE 5

Some of the Major Class of Antibiotics and their Producing Actinomycete Genera

Chemical class of antibiotic	Actinomycete
Aminoglycosides	<i>Streptomyces</i>
Macrolide and ansamacrolide	<i>Micromonospora</i>
Depsipeptide	<i>Actinoplanes</i>
Polvether ionophores	<i>Actinomadura</i>

□□□

EUKARYOTA

All living cells can be divided into two groups, prokaryotes and eukaryotes, based on their ultra structure as seen with the EM. In the microbial world, bacteria, cyanobacteria are prokaryotes. Other cellular microbes- fungi (yeast & molds) protozoa, algae are eukaryotes. The eukaryotic cell is a complex compartmentalized unit that differ from the prokaryotic cell in containing a definite nucleus and several other specialized structures like cell organelles. Although exact cell structures differ somewhat among the several groups of eukaryotic organisms, the eukaryotic cell is the typical cell of certain microbial groups (fungi, algae, protozoans and helminth worms) as well as animal and plants.

The term eukaryotes (from the greek-true nucleus) have linear structures of DNA called chromosomes. These are associated with chromosomal proteins called histone protein. These chromosome are found in the cell's nucleus, which is separated from the cytoplasm by a nuclear membrane. Eukaryotes also have a mitotic apparatus (various cellular structure that participate in a type of nuclear division called mitosis).

Evidence from paleobotany indicates that the first eukaryotic cells appeared on earth approximately two billion yrs ago. One appealing theory suggest that these cells evolved from prokaryotic organism by a process of intracellular symbiosis. The structure of these new cells was so versatile that eukaryotic microorganism soon spread out into available habitats and adopted greatly diverse styles of living.

The first primitive eukaryote were probably single celled and independent, but over time, some forms began to aggregate, forming colonies. With further evolution some of the cells, within the colonies become specialized or adopted to perform particular function advantageous to whole colony such as locomotion, feeding or reproduction.

At some point as individual cells in the organism lost the ability to survive apart from the intact colony, the scene was set for the development of more complex multicellular

organism. A multicellular organism is more than just an assemblage of cell like a colony but it is composed of distinct groups of cells that can't exist independently of rest of the body. The cell grouping of multicellular organism that have a specific function are termed tissues, and groups of tissues make up organs.

All protozoa, algae, fungi live a unicellular or colonial existence. Truly multicellular organism are found only among plants and animals and some of the fungi and algae.

Only certain eukaryotes are small enough to fall into the realm of microbiology, the protozoa, fungi and algae. The fungi, algae, and protozoa are the eukaryotic microorganism evolved along three distinct lines of nutrient, cellular and energy acquisition. The fungi absorb nutrients from host or are parasitic or saprophytic. The algae carry out photosynthesis to form cellular ATP. Protozoa acquire nutrients and energy through ingestion of organic compounds often using phagocytosis to bring nutrients into the cell.

Fungi typically form filamentous mycelia but one group the yeast are characteristically unicellular. The fungi are classified largely on the basis of their modes of reproduction. The sexual spores of fungi are the most important features used in classification and identification of fungi.

The algae are classified largely on the basis of pigment production and biochemical nature of reserve food material.

The protozoa are classified largely on their modes of locomotion.

Next following headings contain a generalized survey of principal eukaryotic microorganism viz.—algae, fungi, slime molds, protozoa etc.

ALGAE

Algae comprise a group of chlorophyll containing thalloid plants of the simplest type, having no true roots, stems, leaves or leaf like organs. They are placed in the division Thallophyta along with fungi. They differ from fungi in the presence of chlorophyll (photosynthetic pigment) and in their mode of nutrition. Although most of the algae are autotrophic, i.e. they synthesize their food by themselves, yet heterotrophic and holozoic forms are not uncommon. The term algae is used even if the plant is a unicellular. The thallus is non-vascular and thus has no elements for the transport of fluids. The algae can afford this simplicity because with only a few exceptions they are water dwellers. They have non jacketed, either unicellular sexorgans or multicellular in which every cell produce a gamete. Most of them are among the simplest in the plant kingdom.

General Characters

1. Mostly aquatic (marine & fresh)
Diverse habitats- below the soil level, moist rocks, wet logs, snow etc.
2. Variety of pigments are present.
3. Simple thalloid plant body.
4. Vascular system is absent.
5. Mechanical tissue is absent.

6. Cell wall is made up of cellulose.
7. Reserve food is starch, oil protein or lipid etc.
8. Non-sterile jacketed uni or multicellular sex organs.
9. In multicellular sex organs every cell of the thallus is capable of producing gametes.
10. Sexual reproduction is of isogamous, anisogamous, or oogamous type.
11. Under favourable conditions algae multiplies asexually.
12. After gametic fusion, no embryo formed.
13. Haploid and diploid life cycles are independent i.e. distinct alternation of generation is present.

HABIT & HABITAT

The algae are predominantly aquatic and are found in fresh water or salt water reservoirs. Some are terrestrial and grow in wet conditions, such as, on damp soil, damp shaded sides of trees and walls or even rocks and thus have adopted themselves to a life in the air.

1. Aquatic Habitats
2. Terrestrial Habitats
3. Aerial Habitats
4. Unusual Habitats

I Aquatic Habitat

Usually occur in ponds, pools, tanks, ditches, streams or in slow running rivers and are called fresh water forms. Marine algae are found in sea. Macroscopic large thalli of brown algae are commonly known as 'sea weeds'.

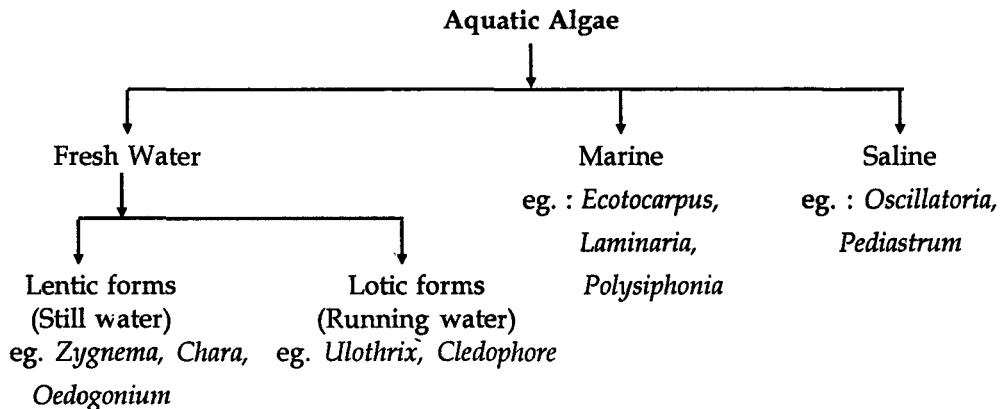

II. Terrestrial Habitat

Many algal genera are found on or beneath the moist soil surface and are called terrestrial algae.

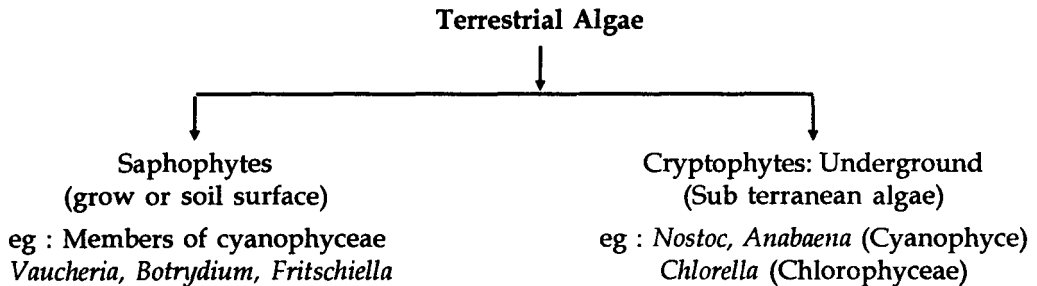

III. Aerial Habitat

Such algae forms as are adapted for aerial mode of life and occur on the tree trunks, moist walls, rocks, fencing wires and get their water and carbon dioxide requirements, completed directly from atmosphere are called Aerophytes.

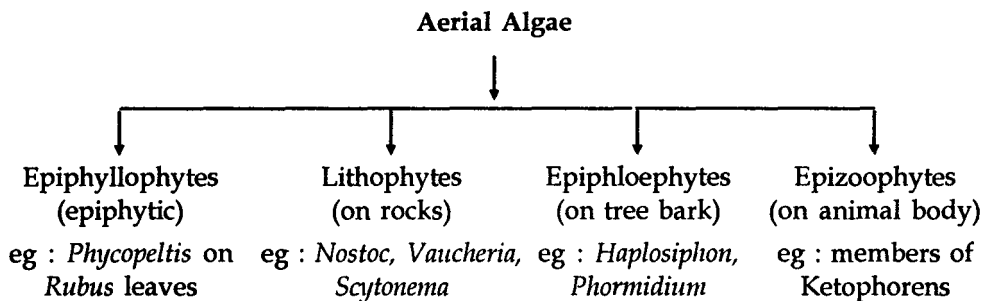

IV. Unusual habitat: Adopted according to habitat.

1. **Cryophytes:** On snow, they can appeared coloured ice – Red, yellow, Green, Blue ice eg.- *Achylonema, Pleurococcus*
2. **Thermophytes:** Algae found in hot springs where temperature between 50-70°C eg- Blue Green algae (*Oscillatoria, Heteroharmogonium*)
3. **Symbiotic:** In Lichens, algae and fungi associated as symbionts.
Cyanophyceae – *Chroococcus, Microcystis, Nostoc*
Chlorophyceae – *Chlorella, Protococcus, Palmella*
4. **Endophytic:** Inside the plants eg. *Anabaena* – In Pteridophyte (*Azolla* leaves) and In *Cycas* roots.
5. **Endozoophytic:** Algae found in animal body.
Eg- *Zooxanthella* in sponges. *Zoochlorella* in Hydra.
6. **Parasitic:** Red Rust disease in tea and coffee caused by *Cephaleuros virescens*.

THALLUS ORGANIZATION

The algae exhibit a great diversity in the organisation of the plant body. Algae species found in different forms-unicellular, coloneal, filamentous, parenchyatous.

I. Unicellular thallus: Except Phaeophyceae, many members of other classes have unicellular thallus.

(a) **Amoeboid or Rhizopodial:** Cell wall absent, no definite shape of cells, due to presence of pseudopodia. Eg- *Crysamoeba*, *Rhizochloris*.

(b) **Flagellated:** Flagellated motile algae eg. *Euglena*, *Chlamydomonas*

(c) **Non flagellated:** Circular, Non flagellated also known as coccoid or protococoid eg. *Chlorella*, *Spirulina*, *Diatoms*

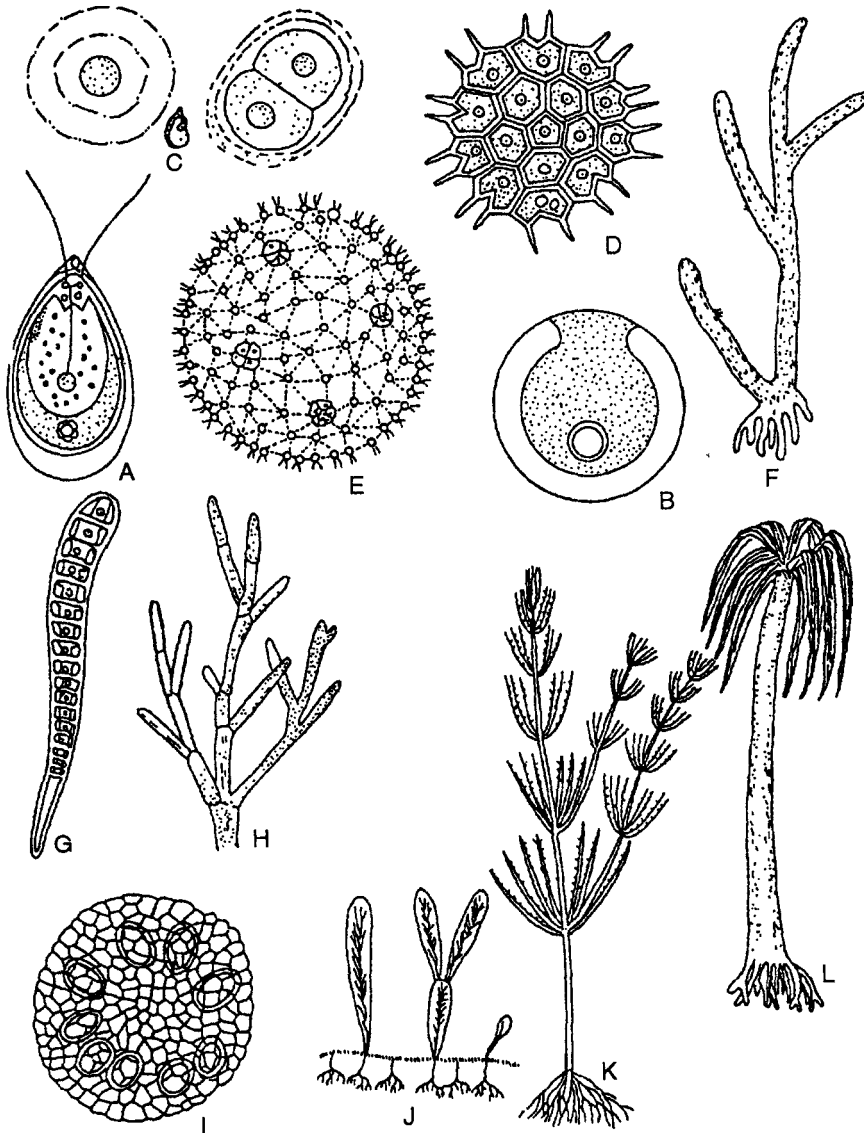

Fig. 1 : Range of thallus organisation Algae (A) *Chlamydomonas* (B) *Chlorella* (C) *Gloeocapsa* (D) *Pediastrum* (E) *Volvox* (F) *Vaucheria* (G) *Ulothrix* (H) *Cladophora* (I) *Coleochaete* (J) *Caulerpa* (K) *Chara* (L) *Pastelsia*

II. Multicellular Thallus: Multicellular thallus organisation found in following types:

(a) Aggregation

(b) Colonial

(c) Filamentous

(d) Siphonous

(e) Parenchymatous

(a) **Aggregation:** When unicellular algae live together in groups they are called as aggregates. Aggregated cells formed irregular colony, and cells multiples regularly.

(i) **Palmelloid:** Circular, non motile cells embedded into gelatinous matrix. Shape and number of cells are not fixed. Each cell of the colony is free physiologically from each other. eg- *Tetraspora*, *Palmella*, *Microcystis*.

(ii) **Dendroid:** Appeared like a small microscopic tree. The branched structure of the tree is made up due to mucilaginous threads. eg- *Chrosodendron*

(iii) **Rhizopodial:** Each cell of the colony fixed with rhizopodia. Eg-*Chrysidiastrum*.

(b) **Colonoid:** Definite size and shape of the colony. Number of cells in colony is also fixed. The colony is also known as coenobium. They are of two types:

(i) **Flagellated/Motile:** Flagellated cells are connected with plasmodesmata and circular in shape. Eg- *Pandorina*, *Eudorina*, *Volvox*

(ii) **Non flagellated:** Non motile cells are present in the colony. Different shapes of the coenobium like, circular, plate or mat colony present. eg.- *Padiastrum*, *Scenedesmus* and *Hydrodictyon*.

(c) **Filamentous Thallus:** These forms of algae are formed by regular division of the cells. They join in a line giving rise to a filamentous form daughter cells arrange in linear forms. In this type, cells are non motile and appeared in a filamentous shape. These filaments could be either.

(i) **Unbranched filaments:** Simple unbranched filaments are found in members of *Spirogyra*, *Oedogonium*, *Ulothrix*, *Nostoc*, etc. In *Ulothrix* and *Oedogonium*, hold fast cell present at the basal end of the filament. Free floating filaments are found in *Spirogyra*.

(ii) **Branched filaments:** Branching can be seen due to the presence of lateral out growth at the lower part of filament, followed by formation of transverse septum. eg- *Pithophora*, *Cladophora*

Three types of branching are as follows:-

(a) **Simple:** Thallus made by single filament with a basal cell at basal end. Except basal cell, other cell induce branching eg - *Cladophora*. In this type the branching trichomes are attached with the help of basal cell to the substratum on which they grow.

(b) **Heterotrictous:** Both erect and prostrate branching present more evolve thallus as compare to simple one. eg- *Coleochaete*, *Ectocarpus*

(c) **Pseudoparenchymatous:** In some members, filaments and branches joined together longitudinally or transversely and develops pseudoparenchymatous type of thallus. Depending upon the number of main filament forming the thallus, it is called as uniaxial or multiaxial.

1. **Uniaxial:** When uniaxial branches are fused. Here only the single central filament possesses an apical cell and this is capable of independent growth eg- *Batrachospermum*.

2. **Multiaxial:** When two or more filament develops from a single basal cell and fused together. eg- *Polysiphonia*

(d) **Siphonous:** Thallus develops from tubular, aseptate branched and multinuclear filaments. eg- *Vaucheria*, *Botrydium*

(e) **Parenchymatous:** Cellular division in different planes, convert a parenchymatous body, where daughter cells fused together. Eg- *Ulva*, *Laminaria*, *Sargassum*.

ALGAL PIGMENTS

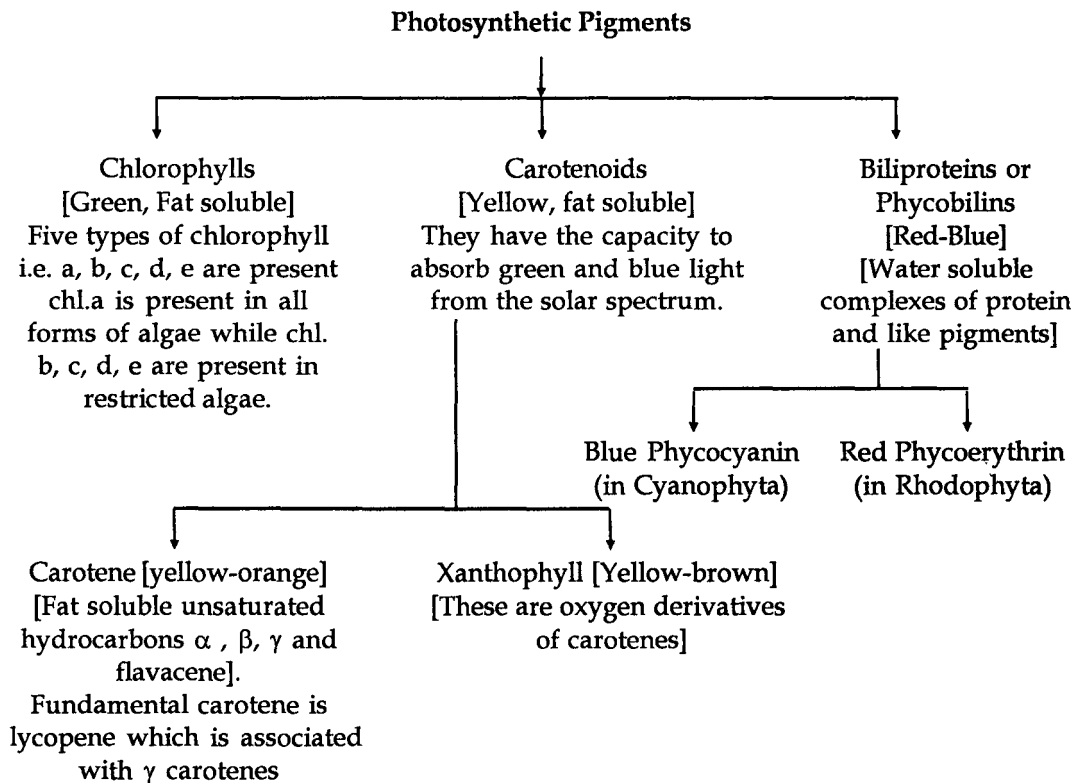

TABLE 1
Photosynthetic Pigments in Algae

S. No.	Class	Chlorophyll	Carotenes	Xanthophylls	Phycobilins or Biliproteins
1.	Chlorophyceae	Chlorophyll-a and b	α , β carotene	Astaxanthin, Leutein, Violaxanthin, Neoranthin, Siphonein, Siphonoxanthin, Cryptoxanthin	-
2.	Xanthophyceae	Chl- a, e	β -carotene	Flavacin, Flavoxanthin, Leutein, Violaxanthin, Neoxanthin	-
3.	Chrysophyceae	Chl-a, e, d, c	β -carotene	Leutein, Violaxanthin, Neoxanthin, Flavacin, Flavoxanthin, Diatoxanthin	-
4.	Bacillariophyceae	Chl-a & c	β -carotene ϵ -carotene	Diatoxanthin, Diadinoxanthin, Fucoxanthin	-
5.	Phaeophyceae	Chl - a & c	ϵ -carotene β -carotene	Leutin, Violaxanthin, Fucoxanthin, Neoxanthin, Flavoxanthin	-
6.	Rhodophyceae	Chl - a & d	α -carotene β -carotene	Leutein, Violaxanthin, Zeaxanthin, Neoxanthin, Fucoxanthin, Flavoxanthin, Flavacin	β -Phycoerythrin γ -Phycoerythrin r-Phycocyanin
7.	Cyanophyceae	Chl - a	β -carotene ϵ -carotene	Myxoxanthin, Leutin, Violaxanthin Myxoxanthophyll, Flavoxanthin, Oscilloxanthin	C-Phycoerythrin C-Phycocyanin

RESERVE FOOD

Reserve food in algae is basically polysaccharides (starch) and fats.

Chlorophyceae: Starch present as amylase and amylopectin located in definite chloroplasts.

Euglenophyceae: Starch paramylon.

Xanthophyceae, Bacillariophyceae: Starch as leucosin and fats are present. Located outside chromatophores.

Phaeophyceae: Starch as laminarin, mannitol as alcohol and fucosterol are present outside chromatophores

Rhodophyceae: Floridian starch (outside chromatophores)

Cyanophyceae: Cyanophycean starch and cyanophycean protein granules are present.

ALGAL CELL

The cells constituting the algal thalli are basically of two kinds, prokaryotic and eukaryotic. The prokaryotic cells which constitute thalli of cyanophytes (blue-green algae) have a cell wall which contains a specific strengthening component not found in the cell walls of other algae. It is mucopeptide. The DNA material representing the nuclear body

consists of fibrils which may extend throughout the cell or are concentrated in the central part. The mitotic figures are also lacking. The chlorophyll pigment is bound to photosynthetic lamellae or thylakoids which may be arranged in parallel layers in the periphery of the cytoplasm or form a network extending throughout the cell cytoplasm. They are not organized into grana. The chloroplasts are thus absent and so are the mitochondria, golgi body and endoplasmic reticulum. The ribosomes are, however, present. The nuclear division does not take place by mitosis and no cell plate is formed instead there is a ring like extension of the cell wall. It extends inwards like a diaphragm with decreasing aperture and divides the cell into daughter cells. Such simple cells of blue-green algae (and bacteria) which lack a nuclear membrane, mitochondria, plastids and do not divide by mitosis are called prokaryotic. The cells constituting the thalli of all other algae excepting the blue green are called eukaryotic. The eukaryotic cell has the same structure as is typical of the higher plants.

ALGAL FLAGELLA

The motile cells of algae are provided with fine, protoplasmic, whiplike threads, the flagella. They are extremely fine and hyaline emergences of the cytoplasm. In cells possessing firm cell walls, the flagella are connected with the inner cytoplasm through small pores in the cell wall. There is either a single anterior flagellum (rarely posterior) or the flagella occur in pairs, rarely in great numbers on the cell. The flagella on the cell may be equal (isokont) or unequal (heterokont) in length. When the flagella are inserted laterally one is directed forwards in motion and the other backwards. They function as the locomotory or propelling structures of the cell. Usually there is a single granule at the base of each flagellum. It is known as the blepharoplast.

(a) **Structure of the Flagellum:** Forming the core of the flagellum is an axial or central filament called the axoneme. The latter is surrounded by a cytoplasmic membrane or sheath which terminates short of the apex. The naked, terminal portion of the axoneme is called the end piece. The tip of the end piece may be blunt and rounded or pointed. In cross section the flagellum consists of two inner central simple fibrils forming an elastic axial thread. It is surrounded by nine united, peripheral contractile, thicker protein double fibrils. All are enclosed by sheath which is an extension of the plasma membrane. Each peripheral fibril is composed of two thin fibrils. The two central fibrils are single. They lie side by side and are sometimes enclosed by a sheath of their own. The fibrils are hollow and extend along the entire length of the flagellum. The nine peripheral fibrils join the basal granule but the two central fibrils stop short of the granule. This '9 + 2' pattern of component fibrils is the basic structures of the flagellum of all organisms except the bacteria.

(b) **Kinds of Flagella:** They are of two main types, whiplash and tinsel. The whiplash flagellum has a smooth surface. The tinsel flagellum bears longitudinal rows of fine, minute flimmer hairs arranged along the axis almost to the tip of the flagellum. There may be a single row of hairs as in the Euglenophyta and Pyrrophyta or two as in Chrysophyceae and Phaeophyceae. The hairs arise from the margins of the peripheral fibrils. The whiplash or smooth flagella are also known by other names such as *acronematic* or *peitchgeisel*. The other names for the tinsel flagella are *pantonematic flimmer* or *flimmergeisel*.

The use of an electron microscope has revealed a third kind of flagellum in which the surface of the flagellum is covered by scales (*Chara*) and minute, short, stiff hairs. Manto and Parke (1960) described this type of flagellum in *Micromonas pusilla* (Prasinophyceae). The hairs differ from those on the tinsel type. They can be easily detached.

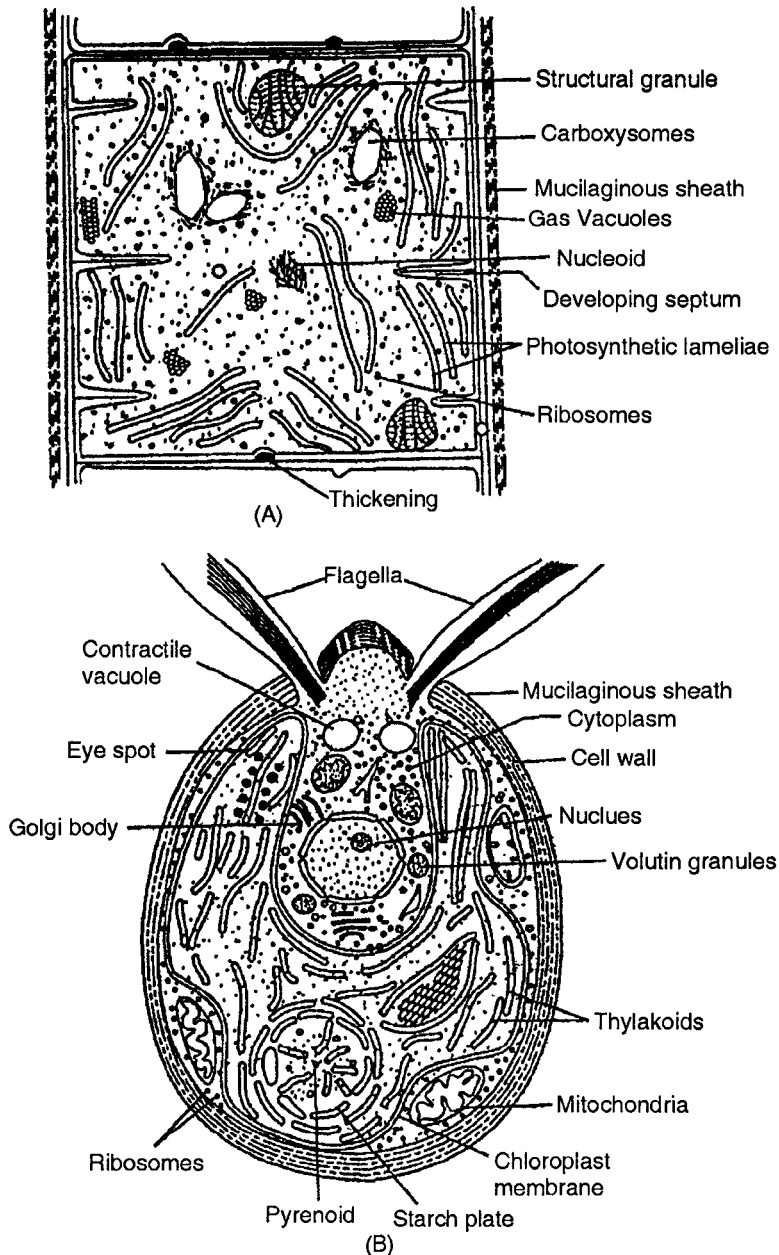
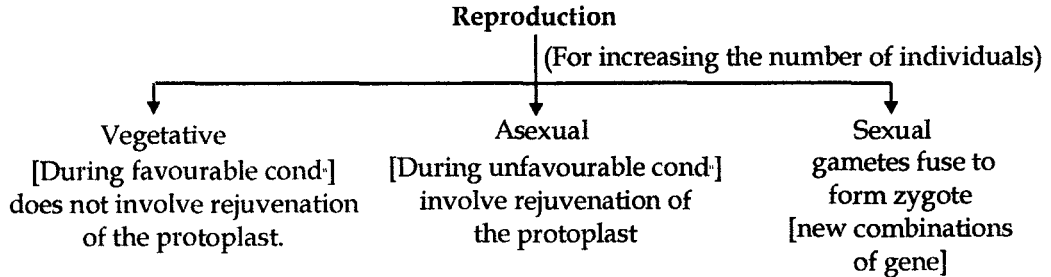

Fig. 2 : Fine structure of Prokaryotic (A) and Eukaryotic (B) Cell of a unicellular algae

REPRODUCTION

In their methods of reproduction, the algae are as diverse as they are in the nature of the thallus. The primitive algae reproduce only by vegetative method but in the higher forms both asexual and sexual reproduction are of common occurrence.



VEGETATIVE REPRODUCTION

(i) **Cell Division:** Found in unicellular algae, like diatoms, desmids eg. – *Pleurococcus*
 (ii) **Fragmentation:** Plant body breaks into small fragments which are capable of forming new individuals. eg.- *Ulothrix*

- (a) Fragmentation due to strong current of water.
- (b) Mechanically injured.
- (c) Increased turgor pressure in the adjacent cells.
- (d) Breaking of filaments by sea animals.

(iii) **Hormogone formation:** Due to mechanical pressure or dissolution of cross walls caused by shearing strains, thallus break into small pieces of two or more cells-known as hormogones. eg : *Oscillatoria*, *Nostoc*

(iv) **Hormosporos:** Modified hormogonia which get covered by thick mucilage. These are large cell filled with stored food. These thick walled structures can easily ward of the unfavourable conditions. Under favourable conditions of growth they germinate directly to give rise a new thallus. eg : *Westiella*

(v) **Adventitious thalli:** On existing thallus adventitious thalli develop. eg- *Dictyota*.

(vi) **Propagules:** Sometimes from the old thallus few celled branches start developing which later detach from parent plant and form complete thallus. eg: *Bryopsis*

(vii) **Budding:** In siphonaceous algae due to vegetative proliferation bud develops and this budding of vesicle form complete thallus. eg *Protosiphon*

(viii) **Bulbils:** Many times on the rhizoids of *Chara* certain small bud like structures full of stored food material develop. These detach and give rise to a new plant. eg- *Chara*

(ix) **Tubers:** Rounded structure are fully laden with food material (starch). When detach give rise to a new plant. eg- *Chara*.

(x) **Splitting of colonies:** When colony attains its maximum size a small constriction starts appearing in the middle of the colony each part develops as a new colony. eg- *Dictyostereum*.

(xi) **By Protonemas:** In *Chara* thread like structure develops from zygote (Primary protonema) or vegetative cells (Secondary Protonema).

(xii) **Amylum or starch stars:** In *Chara* nodal and basal cells produce star shaped cells, which filled with amyllum starch. These star cells when detached from the parent plant give rise to a new plant.

ASEXUAL REPRODUCTION

Protoplast of the cell divides either in the vegetative cells or in special cells called sporangia forming into several protoplasts (spores which may be motile or non motile)

(i) **Zoospores:** Motile and are formed under favourable condition of growth. Naked, motile and fertile cells. The number of flagella present on zoospore:

(a) *Chlamydomonas*-two flagella

(b) *Ulothrix* (Macrozoospore)-four flagella

(c) *Oedogonium*-Many flagella

(ii) **Aplanospores-** Non motile, nonflagellated having a distinct cell wall, developed in unfavourable condition eg. *Ulothrix*, *Protosiphon*

(iii) **Autospores:** Similar to aplanospore but smaller in size. It is present in the parent wall and resembles like the parent cell (except small in size)- *Volvox*, *Eudorina*, *Chlorella*

(iv) **Auxospore:** Formed in the parent cell and give rise to a new plant. eg members of Bacillariophyceae.

(v) **Akinetes:** In few members the protoplast of each cell forms one akinete. They can be develop in chains. Each akinete forms a new plant. eg *Anabaena*, *Cladophora*, *Vaucheria*.

(vi) **Hypnospores:** Thick walled aplanospore which develop under favourable conditions. When favourable condition appear they germinate to give rise a new plant. *Ulothrix*, *Vaucheria*.

(vii) **Endospores:** In Bacillariophyceae and Cyanophyceae, under favourable condition, these structures are produced. On the onset of favourable conditions they germinate to give rise to a new plant. eg- *Dermocarpa*

(viii) **Exospore:** Sometimes from the ruptured portion of the cell protoplast oozes out and give rise to a non-mobile spore. eg- *Chlamydomonas*

(ix) **Palmella Stage:** On the onset of dry conditions, daughter protoplasts of certain algae produced as a result of asexual reproduction do not escape from the cell but their wall gelatinizes and their contents keep dividing thus forming a macroscopic colony. As this stage resembles an algae *Palmella* hence this stage is called as Palmella stage. On the availability of water the contents are released forming either zoospores or aplanospores which germinate to give rise to a new thallus.

(x) **Carpospore:** Formed in carposporophyte, in members of Rhodophyceae. eg- *Polysiphonia*.

SEXUAL REPRODUCTION

Except cyanophyceae sexual reproduction occurs in all algal members. [when gametes fuse to form zygote] on the basis of organs and their complexity, the following six types of sexual reproduction are recognized in different groups of algae:

I. Autogamy: When two gametes of the same mother cell fuse to form a diploid nucleus, it is called autogamy. In this process there is only fusion of two gametic nuclei (Karyogamy). The autogamy lacks incorporation of external genes (do not show new characters) eg - *Diatoms*

II. Hologamy: The vegetative cells of different strains (+) and (-) (female & male) behave as gametes and fuse to form zygote. More advance- it involves fusion of two cells having different genetic constitution eg. Unicellular forms (*Chlamydomonas*)

III. Isogamy: The two gametes which fuse to form zygote, are morphologically and physiologically similar (isogametes). They are usually motile and flagellated. eg- *Ulothrix*, *Chlamydomonas*.

IV. Physiological anisogamy: Gametes are similar in morphological characters, they show physiological variation with (+) and (-) strains. eg - *Spirogyra*, *Zygnema*, *Ectocarpus*.

V. Anisogamy: Gametes are morphologically and physiologically distinct. The male or (microgametes) are smaller and more active, whereas female or macrogametes are larger. eg- *Chlamydomonas*.

VI. Oogamy: Advanced type of sexual reproduction. Large non motile egg or ovum fuses with a small motile sperm or antherozoid (in Rhodophyceae, sperm are non motile). Egg is formed within the oogonium and sperms within the antheridium. eg- *Volvox*, *Oedogonium*, *Chara*, *Vaucheria*, *Sargassum*, *Polysiphonia*.

TYPES OF LIFE CYCLE

The sequence of orderly changes in growth and development of an algae is said to be life cycle. During the process of sexual reproduction gametes fertilize resulting into a diploid zygote, this undergoes reduction division and forms haploid plants or it directly forms a diploid plant. A generation is considered as a somatic phase. The alteration of generation means a situation in which a plant depicts two somatic phases which regularly alternate during the life cycle i.e. haploid (gametophytic) and diploid (sporophytic).

(I) Haplontic Type: Plant is haploid and bears haploid gametes in the gametangium. The gametic fusion results in the formation of a diploid zygote which is the only diploid phase in the life cycle. The zygote nucleus divides meiotically to produce four meiospores, each of these develops into a new individual. Thus, there is an alternation of a haploid plant with a diploid zygote. eg- *Chlamydomonas* (unicellular), *Ulothrix*, *Oedogonium*, *Spirogyra*, *Zygnema* and *Chara*.

(II) Diplontic Type: Diploid plant bears sex organ (gametangia) which are also diploid. The reduction division takes place at the time of the formation of gametes and as such the gametes are haploid. After gametic fusion diploid stage is re-established in the form of zygote. The zygote does not undergo any reduction division and it gives rise to a diploid plant body. Thus, there is an alternation of a diploid plant with haploid gametes. eg: *Cladophora*, *Sargassum* and *Diatoms*

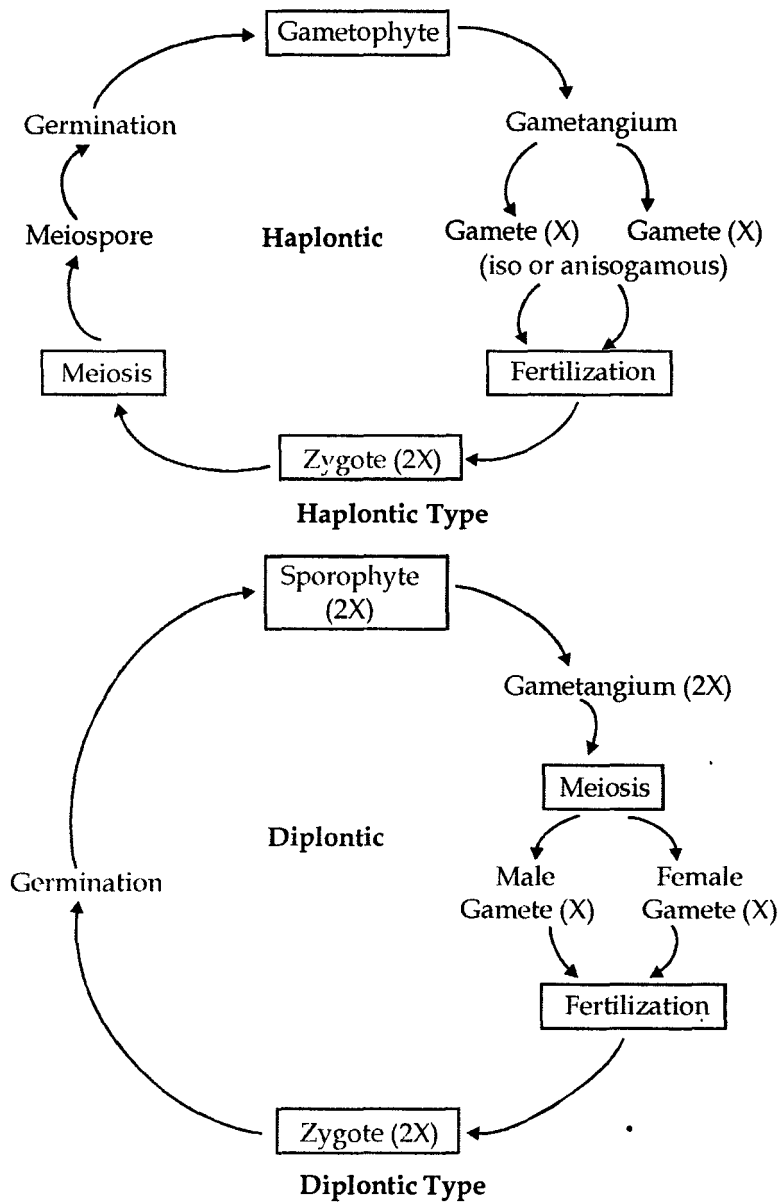

(III) **Isomorphic Type:** Alternation of two generations which are externally similar, but one is haploid (gametophyte) producing gametes and the other diploid (sporophyte) producing zoospores. The zygote germinates directly into a diploid plant without undergoing reduction division. Sporangia develop on the diploid plant body and reduction in the number of chromosomes takes place prior to the formation of zoospores. The haploid zoospores thus formed grow into haploid plants. Sex organs develop on the haploid plants and these give rise to haploid gametes. The haploid gametes fuse to form diploid zygote. eg.- *Ulva*, *Enteromorpha*, *Cladophora*, *Ectocarpus*

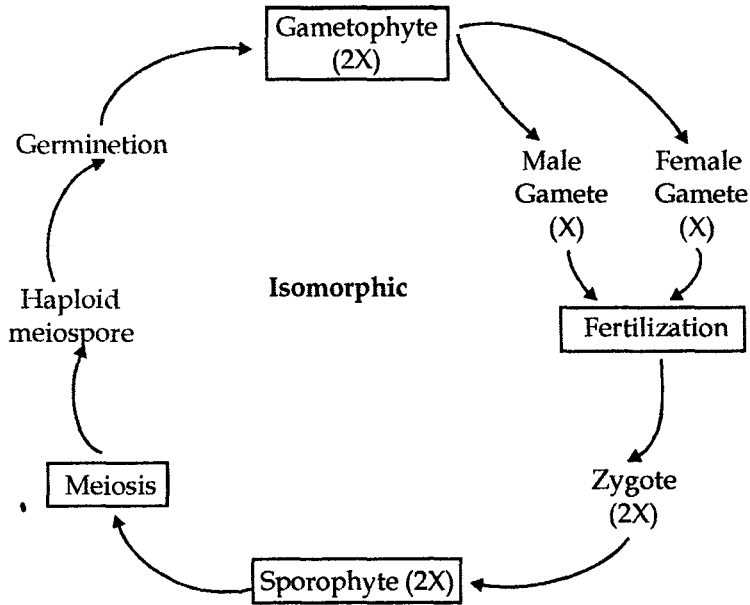

Isomorphic Type

(IV) **Heteromorphic Type:** Both diploid (large sporophytic) and haploid (small gametophytic) plant bodies are morphologically distinct and they alternate with each other. Eg- *Dictyota*, *Laminaria*

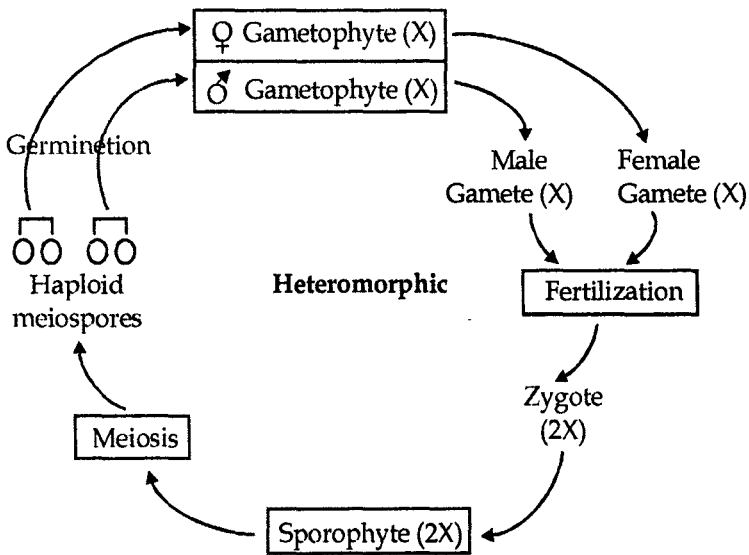

Heteromorphic Type

The diploid plant body are large plant, bearing zoosporangia which produce zoospores after reduction division. The haploid zoospore germinate and produce haploid plant. Haploid gametes are produced in sex organs formed on gametophytic plants. Gametes fuse to form zygote which germinate directly and produce a diploid sporophyte.

(V) **Triphasic Type:** Succession of three generations:

(A) **Haplobiontic:** In some Rhodophyceae members like *Batrachospermum*, two well developed haploid phases are present in the life-cycle, hence this type called haplobiontic triphasic. The diploid phase is represented only by zygote.

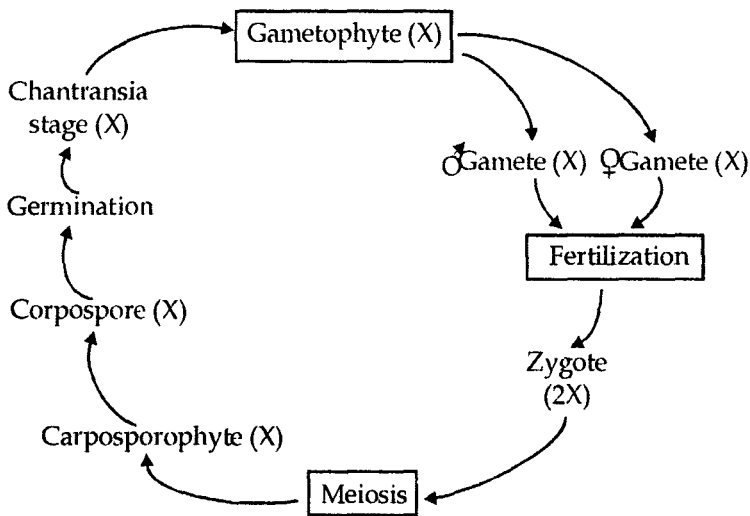

Triphasic Haplobiontic

Pt body of *Batrachospermum* is gametophytic which bears sex organ (spermatangia and carpogonia). Haploid gametes (spermatium and egg) are formed in these sex organs.

Gonimoblast filaments are formed from the basal part of the carpogonium; the upper-most cell of these filaments function as carposporangium. The first division in the zygote nucleus is meiotic and as such the gonimoblast filament are haploid. The haploid carposporangium bears a haploid carpospore. The gonimoblast filaments, carposporangia and carpospores are enveloped by numerous sterile filaments, and together represent carposporophyte generation which is haploid. On liberation, carpospores germinate into heterotrichous Chantransia stage. These filament develop into new gametophytic plant body.

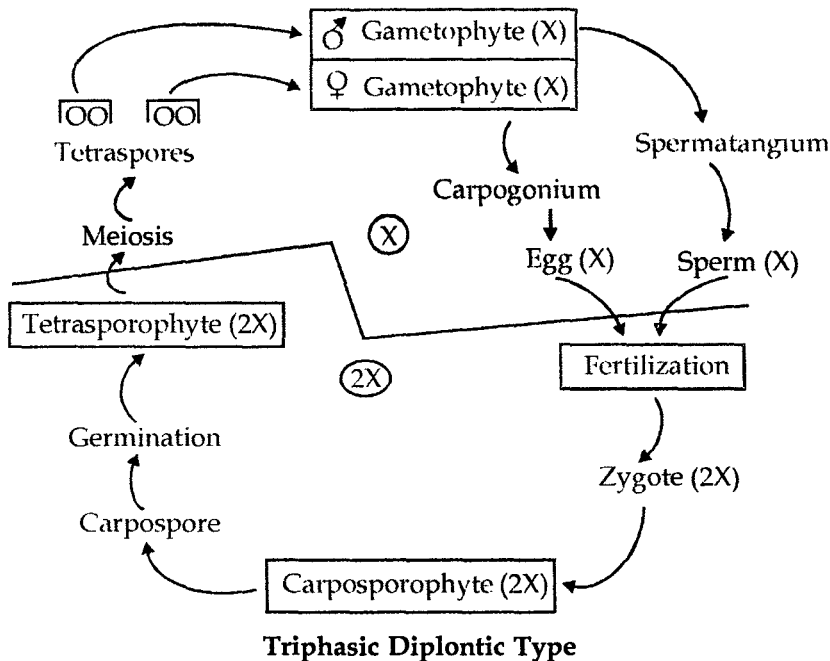

(B) Diplobiontic: There are two diploid phases (carposporophyte and tetrasporophyte) alternating with haploid gametophytic phase. In *Polysiphonia*, haploid phase is represented by male and female gametophytic plants, sex organs and gametes. Gametes fuse to form zygote and zygote produces gonimoblasts which represents an additional diploid phase (carposporophyte). On liberation, the carpospore germinates to produce a diploid tetrasporophytic plant. Four haploid tetraspore are formed by reduction division. Tetraspore give rise to haploid gametophytic plant.

CLASSIFICATION

G.M. Smith (1955) proposed the classification of Algae. He divided Algae into seven divisions, which were further sub divided into classes. The names of divisions and classes are given below:

Division 1: Chlorophyta includes about 5700 forms out of which 90% are fresh water and the remaining 10% are marine. Dominant pigments are chlorophyll a and b, the reserve food starch. Divided into two classes: (1) Chlorophyceae (green algae) e.g., *Volvox*, *Ulothrix*; (2) Charophyceae (stoneworts) e.g., *Chara*

Division 2: Euglenophyta includes 450 fresh water or terrestrial forms. Dominant pigments are chlorophyll and β carotene and reserve foods are paramylum and fats. Has been divided into a single class Euglenophyceae (the euglenoids) e.g., *Euglena*

Division 3: Pyrrophyta include 1000 species mainly unicellular rarely colonial. Pigments are chlorophyll a & c, carotene and xanthophylls. Reserve foods is starch/oil. Divided into two classes: (1) Desmophyceae (dinophysids) e.g., *Desmarestia*; (2) Dinophyceae (Dinoflagelloids) e.g., *Dinophysis*

Division 4: Chrysophyta represented by 6000 species of which 75% are freshwater and the remaining 25% marine. Dominant pigments are carotene and xanthophylls and reserve food is leucosin and oil. Divided into three classes: (1) Chrysophyceae (golden brown algae) e.g. *Chromulina*; (2) Xanthophyceae (yellow green algae) e.g., *Botrydium*; (3) Bacillariophyceae (diatoms) e.g., *Pinnularia*.

Division 5: Phaeophyta (Brown algae) represented by 1000 mostly marine forms, dominant pigments are phycophyein and fucoxanthin and reserve foods are laminarin and mannitol. Divided into three classes: (1) Isogeneratae eg. *Ectocarpus* (2) Hetergeneratae e.g. *Myrionema* and (3) Cyclosporae e.g., *Sargassum*.

Division 6: Cyanophyta (Blue green algae). Represented by 1500 mostly fresh water species pigments are chlorophyll a & b, C-phycoyanin and C-phycoerythrin and the reserve food is cyanophycean starch. Motile cells absent. Divided into a single class Myxophyceae eg. *Nostoc*, *Anabaena*.

Division 7: Rhodophyta (Red Algae) includes 2500 species mostly marine. Predominant pigments are r-phycoerythrin. Reserve food is floridean starch. Division contains only one class Rhodophyceae e.g., *Polysiphonia*, *Gracilaria*, *Batrachospermum* (fresh water).

Christensen (1964) proposed a new scheme of primary classification of algae into Prokaryota and Eukaryota on the basis of difference between the prokaryotic and eukaryotic cells. It is briefly given below:

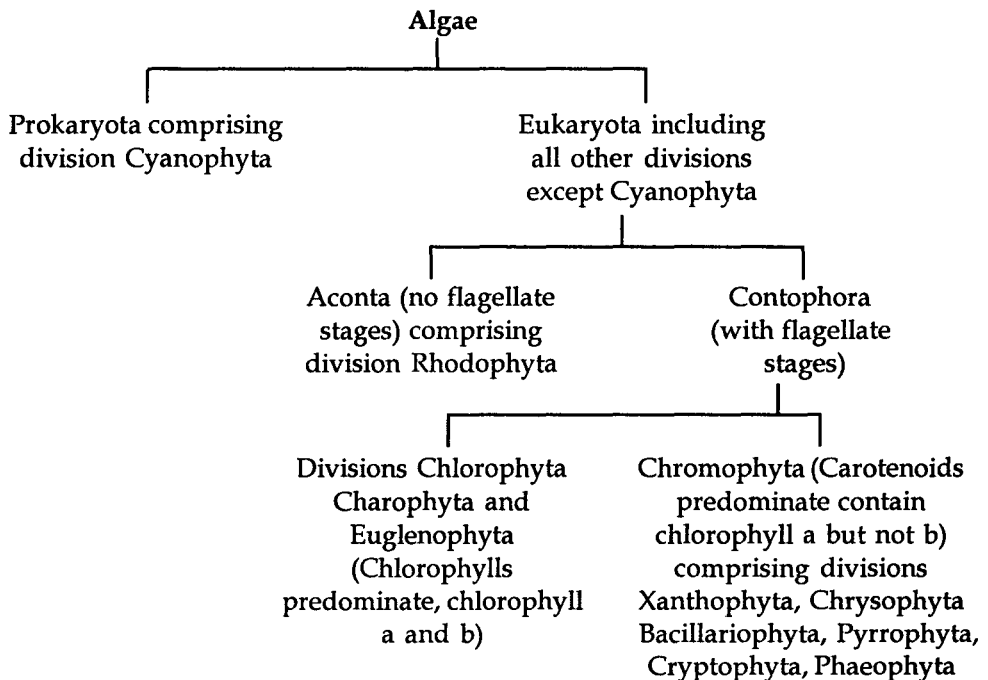

G.W. Prescott (1969) emphasized the presence or absence of true nucleus in the algal cells for their classification along with other characters viz. pigmentation, biochemical

nature of cell wall and reserve food material and divided algae into nine phyla and fourteen classes. The scheme proposed by him is as follows:

Phylum I Chlorophyta: Eukaryotic algae with chloroplasts surrounded by one membrane of chloroplast endoplasmic reticulum.

Classes (i) Chlorophyceae

(ii) Charophyceae

Phylum II Euglenophyta: Chlorophyll a and b, storage product paramylon.

Phylum III Chrysophyta-Chl. a and xanthophylls (golden brown algae)

Classes (i) Chrysophyceae

(ii) Bacillariophyceae

(iii) Heterokontae (xanthophyceae)

Phylum IV Pyrrophyta: mesokaryotic nucleus, chl a and c.

Classes (i) Desmokontae (Desmophyceae)

(ii) Dinokontae (Dinophyceae)

Phylum V Phaeophyta: Chl a and c, fucoxanthin, storage product chrysolaminarin occurring in vesicles in cytoplasm.

Classes (i) Isogeneratae

(ii) Heterogeneratae

(iii) Cyclosporeae

Phylum VI Rhodophyta: Chl a and b, phycobiliproteins, storage product -floridian starch.

Classes (i) Bangioideae

(ii) Florideae

Phylum VII Cyanophyta - Chl a, phycobiliproteins

Classes (i) Coccogoneae

(ii) Hormogoneae

Phylum VIII Cryptophyta- Chl a and c, starch is reserve food.

Phylum IX Chloromonadophyta

THE FUNGI

Once, fungi and bacteria were considered parts of the plant kingdom, primarily because they produce spores, have cells walls and obviously are not animals. Now it has become clear that the organisms grouped together as fungi are definitely not plants.

The name of the fungi is derived from their most obvious representatives, the mushrooms (Greek, *mykes*, latin, *fungus*). They are eukaryotes and share with plants the possession of a cell wall, liquid-filled intracellular vacuoles, microscopically visible streaming of the cytoplasm and (almost universal) lack of motility. However, they do not

contain photosynthetic pigments and are chemo-organoheterotrophs. Most grow aerobically and obtain their energy by oxidation of organic substances. Compared to the plants, which are organized into stems, roots and leaves, fungi show only very limited morphological differentiation and practically no functional differentiation.

Classification of Fungi and Related Organisms

Kingdom - Myceteae

Division - Myxomycota - Slime molds

Division Eumycota - True fungi

Sub division Mastigomycotina - Fungi with motile cells

Class - Chytridiomycetes

Class - Hyphochytridiomycetes

Class - Oomycetes

Sub division Zygomycotina - Fungi with zygospores

Sub division Ascomycotina - Fungi with asci

Sub division Basidiomycotina - Fungi with basidia

Sub division Deuteromycotina - Fungi without known sexual stages

General Characteristics of Fungi

Fungi constitute a large group of organisms, although about 100,000 species have been named, 200,000 more species are estimated to remain undiscovered. Like insects and orchids, fungi are quite possibly speciating rapidly than they are being discovered.

The Vegetative body: The vegetative body is a thallus. It consists of filaments about 5 μm in diameter which are multiply branched and spread over or into the nutrient medium. The filaments or hyphae consist of a cell wall and cytoplasm with its inclusions. The hyphae may be without cross walls (in the lower fungi) or divided into cells by septa in the higher fungi. However, even in the septate hyphae, the cytoplasm of the cells is continuous via a central pore in the septum. The total of the hyphal mass of a fungal thallus is called the mycelium. In certain stages, often during transition to the sexual or asexual reproduction phase, the mycelium forms tissue like aggregates, the so-called plectenchyma. A typical plectenchyma is the 'flesh' of the mushroom. In the higher fungi, the mycelium may also form thick strands, rhizomorphs, which function to transport nutrients.

Nutrition

A universal characteristic of fungi is that they are completely heterotrophic; no trace of photosynthesis is found in any stage of any group. However, because they have walls, fungi cannot engulf food as animals do; instead, fungi must obtain nutrients from the environment from living, dying or dead organisms. On this basis, fungi are subdivided into three types: (1) biotrophs (parasites), which draw nutrients slowly from living hosts,

often without killing them; (2) necrotrophs, which attack living hosts so virulently that they kill the hosts and then absorb released nutrients. (3) saprotrophs, fungi that attack organisms after they have died from other causes.

Many biotrophs secrete chemicals that cause the host cell membrane to become unusually permeable to sugars or amino acids, as they leak from the host cell, the fungus absorbs them. In sophisticated parasites, damage to the host cell is so slight that the plant responds as though the fungus were a normal sink for metabolites, and extra sugars and amino acids are actually transported by the plant from other leaves to the site of infection, just as though the fungus were a developing fruit or other plant part. In biotrophic attacks, fungal cells may remain confined solely to intercellular spaces; in other species; the fungus creates a small hole in the plant cell wall, then inserts a small portion, the haustorium, of its filamentous cell through the hole. The haustorium is in close contact with the plant cell plasma membrane, which probably makes it easier to absorb nutrients.

Extracellular Digestion: Natural release of sugars may be sufficient for the fungi, but typically they secrete digestive enzymes that attack host polymers, converting them to sugars, amino acids, and lipids that can be absorbed. Saprotrophs depend predominantly on this form of extracellular digestion, and many depolymerize and consume cellulose (brown rot fungi), hemicelluloses, and even lignin (white rot fungi). The ability either to absorb host-produced monomers or to secrete extracellular digestive enzymes is often both species specific and tissue specific. Many biotrophic and saprotrophic fungi can attack successfully only a few or just one host species, or even just a single variety of one plant species. Many fungi are even tissue specific: Wilt-inducing fusariums must invade xylem and attack xylary middle lamellas; they cannot survive in cortex, pith, or phloem even though those cells are rich in free monomers. Fungi transmitted by aphids and other phloem-sucking insects usually are able to attack only phloem: their toxins and extracellular enzymes are not effective against other tissues.

Growth and reproduction: Fungal hyphae elongate at their apices (apical growth). In most fungi every part of the mycelium has the potential for growth (elongation); a small piece of mycelium is sufficient for inoculation to produce a new thallus. However, the forms and mechanisms involved in the reproduction of fungi are extremely diverse and are used as the basis for classification. Two kinds of reproduction are distinguished, namely sexual and asexual. Most fungi can reproduce in both ways. A universal character of fungi is their formation of spores, resistant resting stages that are the primary means of reproduction, dispersal and survival, spores are produced either asexually or sexually.

Asexual reproduction of fungi is mostly by budding, fragmentation, or formation of spores. Spore formation is the most widely distributed and most highly differentiated method. Conidiospores are budded off at hyphal apices (in *Penicillium*, *Aspergillus*). When these arise inside sporangia (i.e. receptacles), the fungi are grouped as sporangiospores (*Mucor*, *Rhizopus*). In the lower fungi, sporangia are often motile by means of flagella and are called zoospores. The flagella conform to the typical eukaryotic model: they originate from a blepharoplast in the cytoplasm and consist of eleven parallel fibrils of which nine peripheral fibrils are arranged concentrically around two central ones (9 +2).

The asexual reproduction characteristic of yeasts (budding fungi) is budding; the

mother cell forms an out growth which receives a daughter nucleus, where upon the nucleated out growth is pinched off as a 'bud'. Asexual reproduction can also occur by fragmentation of the hyphae into single cells, the oidia or arthrospores (e.g. in the milk mould *Endomyces lactis*). In some fungi these cells are surrounded by a thick wall and are referred to as chlamydospores. Finally, there are some yeasts (*Schizosaccharomyces*) which reproduce by binary fission in a manner similar to bacteria.

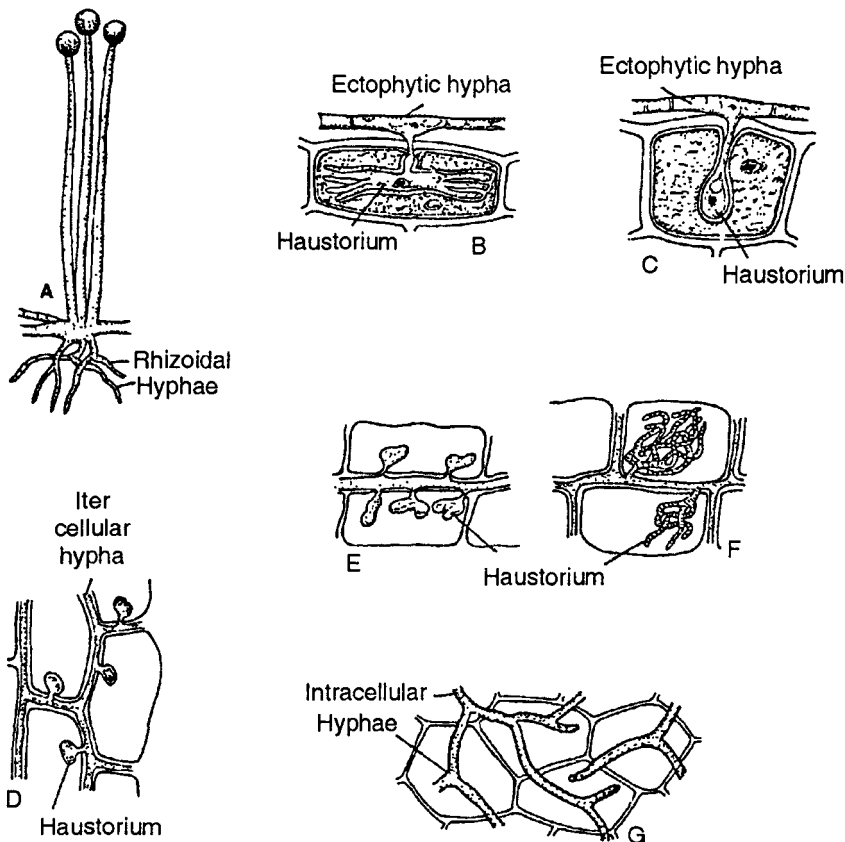

Fig. 3 : Modes of Nutrition

Sclerotia (Sing: sclerotium) are more elaborate and even more resistant; they develop as a section of mycelium branches profusely and the hyphae attract each other, forming a compact aggregate. The outermost hyphae are swollen and globose and have thick melanized walls. The inner mass consists of large hyphae (filled with nutrients such as oil, glycogen, mannitol, and trehalose) and small, thin-walled hyphae (rich in cytoplasm and organelles). Rather than remaining distinct, the hyphae undergo numerous fusions with each other, forming a highly interconnected mass. Large amounts of mucilage are secreted around the hyphae, which seems to act as a water-holding substance. Sclerotia are often formed by biotrophic fungi, and their germination frequently depends not merely on good conditions but on conditions favorable for the host as well. The sclerotia of

Sclerotium cepivorum germinate only when a host root happens to grow next to it, and those of *Claviceps* germinate in the spring, just when the host grasses are starting to produce flowers.

Sexual reproduction: This, as in all other eukaryotes, comprises the union or conjugation of two nuclei. In different fungi, the nuclear fusion may occur at different intervals after the first parental contact. Sexual reproduction can usually be divided into three phases.

Plasmogamy, the fusion of two protoplasts. The resulting cell has two nuclei. This nuclear pair or dikaryon does not need to fuse immediately, but it can persist in the dikaryotic state during the rest of the cell division, the two nuclei dividing simultaneously (conjugative division). The fusion of the two haploid nuclei (karyogamy) may occur later, often only after formation of a fruiting body, to give the diploid nucleus of the zygote. Following karyogamy, meiosis, the reduction division of the chromosomes to the haploid number, takes place. These three processes or stages, plasmogamy, karyogamy, and meiosis, may occur in immediate sequence in some fungi, but in others they can occur during quite different stages of development.

In the lower fungi the phase of sexual reproduction is initiated by the formation of gametes, i.e. sexual cells. When the gametes formed by the male and female parental cells are indistinguishable morphologically they are called isogametes. The gametes are often formed inside morphologically differentiated cells, which are called gametangia, and when these are morphologically distinct, the male gametangia are called antheridia and the female ones are called oogonia.

The ways in which the gametes are transferred and plasmogamy achieved can again be sub divided into various kinds. In lower fungi, especially in aquatic ones, both gametes are usually motile (planogametes) and fuse outside the gametangia (i.e. after liberation from the gametangia). In the oomycetes only the male gamete is motile; it penetrates the oogonium and fertilizes the ovum. Zygomycetes are characterized by gametangiogamy, the fusion of whole, multinucleate gametangia into a coenozygote.

When the male and female gametangia originate from the same vegetative body (produced from a single spore), the organism is referred to as a homothallic or hermaphrodite fungus (monozoic). In heterothallic, or dizoic, fungi the thalli are either male or female, that is, they bear only male or female sex organs. Homothallic fungi can be self-fertilising (autogamous). However, in some homothallic fungi no self-fertilisation occurs due to some physiological inhibitory mechanism, which is referred to as incompatibility. This is the case in *Neurospora*, for example, which, though homothallic, needs conjugation between members of different types (+ and -) to establish fertilization, individuals belonging to the same type are incompatible.

Classification

The classification of fungi, like that of bacteria, is designed mainly for practical application but it also bears some relation to phylogenetic considerations. The nomenclature is binomial, with a generic and a specific name (eg: *Aspergillus niger*). Species are collected in genera, genera in families (suffix -aceae), families in orders (suffix -ales), and orders

in classes (suffix-mycetes). The division of mycota, or fungi and moulds, includes the true slime moulds (Myxomycetes), the lower fungi (Phycomycetes), and the higher fungi (Eumycetes).

Alexopolous and Mims proposed fungal classification in 1979. They place the fungi including the slime molds in the kingdom mycetae of the super kingdom Eukaryota which, in addition, includes four other kingdoms. They divide the kingdom mycetae into three divisions namely: 1. Gymnomycota 2. Mastigomycota and 3. Amastigomycota. The division is sub divided into subdivision, classes, sub-classes and orders.

Division I Gymnomycota

It includes phagotrophic organism devoid of cell walls. This division comprises two sub divisions. These are Acrasiogymnomycotina and Plasmodiogymnomycotina.

Sub division 1. Acrasiogymnomycotina

It includes a single class Acrasiomycetes.

Class 1. Acrasiomycetes

Lacks flagellated cells except one species. The class comprises two sub classes. Acrasiomycetidae and Dictyosteliomycetidae.

Sub division 2. Plasmodiogymnomycotina

It is divided into two classes:

Class 1 Protosteliomycetes

Class 2 Mycomycetes

It includes the true slime mold and comprises three sub class namely:

Sub class 1. Ceratiomyxomycomycetidae

Order - Ceratiomyxales

Sub Class 2. Mycogasteomycetidae- It comprise four orders.

Order 1 Liceales

2. Echinosteleales

3. Trichlales

4. Physarales

Sub Class 3. Stemonitomycetidae

Order 1. Stemonitales

Division II Mastigomycota

Includes fungi with absorptive nutrition, unicellular or filamentous, mycelium coemocytic. It comprises two sub divisions

Sub division 1 Haplomastigomycotina

Includes fungi with uni-or, bi-flagellate zoospores.

Class 1 Chytridiomycetes- Fungi producing zoospores furnished with a single whiplash flagellum inserted at the posterior end.

Class 2 Hyphochytridiomycetes- Motile cells with a single tinsel flagellum inserted at the anterior end.

Class 3 Plasmodiophoromycetes- Parasitic fungi producing biflagellate motile cells with both the flagella of whiplash type inserted at the anterior end.

Sub division 2. Diplomastigomycotina

Sexual reproduction oogamous, zoospores biflagellate.

Class 1 Oomycetes - It comprises four orders:

Order 1 Lagenidiales

Order 2 Saprolegnales

Order 3. Leptomitales

Order 4. Peronosporales

Division III Amastigomycota

Fungi with absorptive nutrition, motile cells lacking, mycelium aseptate or septate. This includes four sub divisions:

Sub division 1. Zygomycotina

Class 1 Zygomycetes - it includes six orders.

Class 2 Trichomycetes - it comprises five orders.

Sub division 2 Ascomycotina

Fungi usually with a septate mycelium producing haploid ascospores in sac like cells called asci.

Class 1 Ascomycetes- divided into five sub classes:

Sub class 1. Hemiascomycetidae- comprising three orders.

Sub class 2. Plectomycetidae- Five orders

Sub class 3. Hymenoascomycetidae - Ten orders

Sub class 4 Laboulbeniomycetidae - Two orders

Sub class 5 Lowloascomycetidae - five orders

Sub division 3. Basidiomycotina

Septate mycelium, produces basidiospores, exogenously on various types of basidia.

Class 1 Basidiomycetes: it is split into 3 sub classes:

Sub class 1 Holobasidiomycetidae

Sub class 2 Phragmobasidiomycetidae

Sub class 3 Teliomycetidae

Sub division 4. Deuteromycotina

It includes imperfect fungi in which sexual stage is unknown. It comprises a single form class.

Form Class 1 Deuteromycetes with three form sub classes namely Blastomycetidae, Coelomycetidae and Hyphomycetidae.

Another classification of fungi was proposed by Ainsworth (1973) which has been accepted by many mycologists of today like Webster (1980), Bilgrami (1985) and Dube (1987). Ainsworth placed all the fungi in the kingdom Mycota. His classification is as follows:

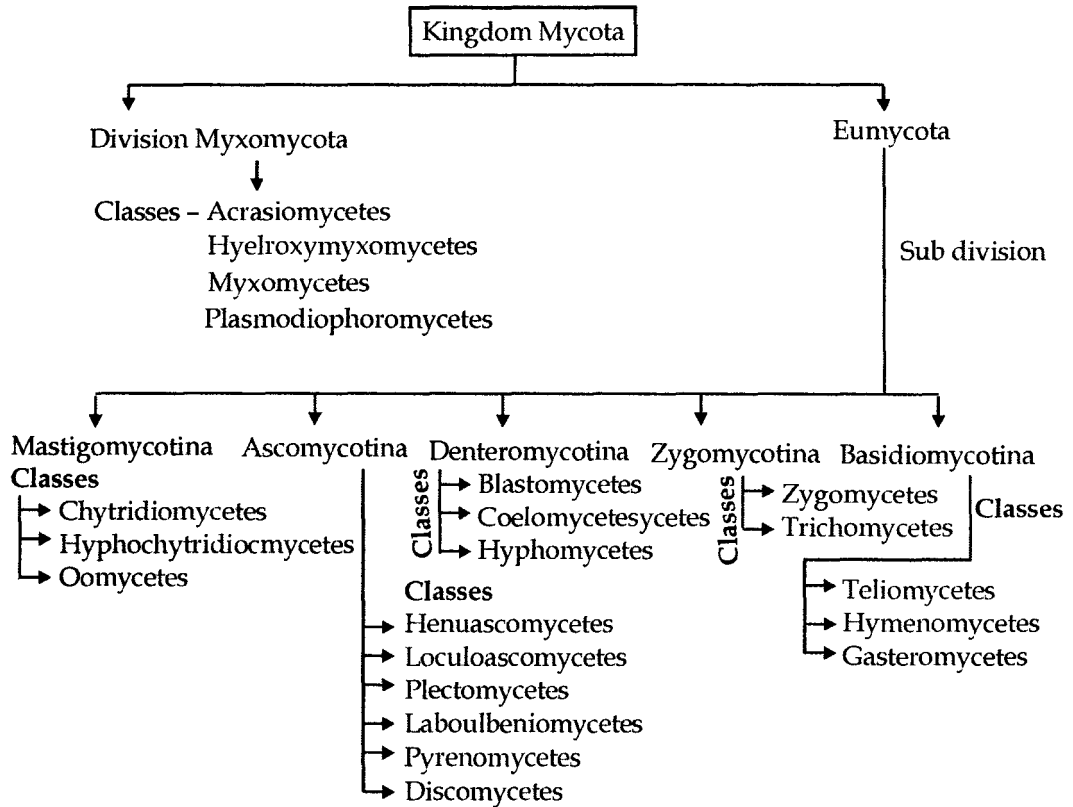

DIVISION-MYXOMYCOTA THE SLIME MOLDS

The division contains slime molds, organisms quite distinct from true fungi. They are heterotrophic and form spores, but they lack walls and have a unique body organization. In true slime molds, the body is a large mass of protoplasm (slime) with a volume of several cubic centimeters containing thousands or millions of nuclei, all in the same cytoplasm and covered only by a plasma membrane. This mass of protoplasm, called a plasmodium (pl: plasmodia), is capable of migrating over a substrate, much like an amoeba, but is so large that it is easily visible to the naked eye. The plasmodium digests material from the substrate as it moves along; bacteria; yeasts, and decayed plant material

are the most common nutrients and are engulfed just as bacteria are engulfed by an amoeba. Such consumption of particulate matter is not possible in true fungi because of their rigid cell walls.

The slime molds are of two types, acellular and cellular. The somatic phase in the former is called the plasmodium. It is a free living, multinucleate, apparently naked protoplasmic mass. It is holocarpic. The somatic phase in the cellular slime molds is termed the pseudoplasmodium.

In response to environmental cues, a plasmodium aggregates its protoplasm, forming one or several mounds; it then extends upward, producing sporangia on stalks. Spores with true walls are formed and released; the spores are extremely resistant, surviving for many years even under adverse conditions. Meiosis occurs after the spores form; then three nuclei degenerate. Upon germination, the spores may release either an amoeboid or a flagellated cell, and the two forms are interconvertible. The cell grows and may undergo both nuclear and cellular division proliferating into a population of haploid cells. Each cell contains mating type factors, and when two compatible cells meet, they fuse into one mass, mixing the two types of nuclei. Fusion is not limited to two cells; many cells may fuse, resulting in a multi-nucleate plasmodium. Karyogamy occurs shortly thereafter, and nuclei are then diploid. The plasmodium continues to migrate and feed until induced to undergo another round of spore formation.

The phylogenetic- evolutionary - relationships of slime molds to other organisms are not known. They may represent a surviving line of evolution which originated not long after eukaryotes arose and which has changed little since. It is also possible that some are extremely reduced forms that evolved from more advanced organisms. Uncertainty about their evolutionary position is compounded because other groups-cellular slime molds, protostelids and net slime molds have other combinations of fungal and non fungal characters.

The characteristic features of Myxomycetes:

1. The somatic phase is represented by a multinucleate apparently naked acellular slimy protoplasmic mass called plasmodium.
2. The plasmodium is the product of syngamy (Diploid).
3. The diploid plasmodium is holocarpic, free living and active. It contain and secretes slime.
4. Normally at the fruiting time, the entire plasmodium is organized into one or more plant like reproductive structures, the sporangia (sporophores) or under conditions of stress and strains it becomes converted into an irregular hard structure, the sclerotium.
5. The sporangium generally develops a tough non-cellular layer or wall called the peridium which is often studded with tiny crystals of calcium salts.
6. Within the peridium is usually an intricate network of fine tube-like structures constituting the capillitium.

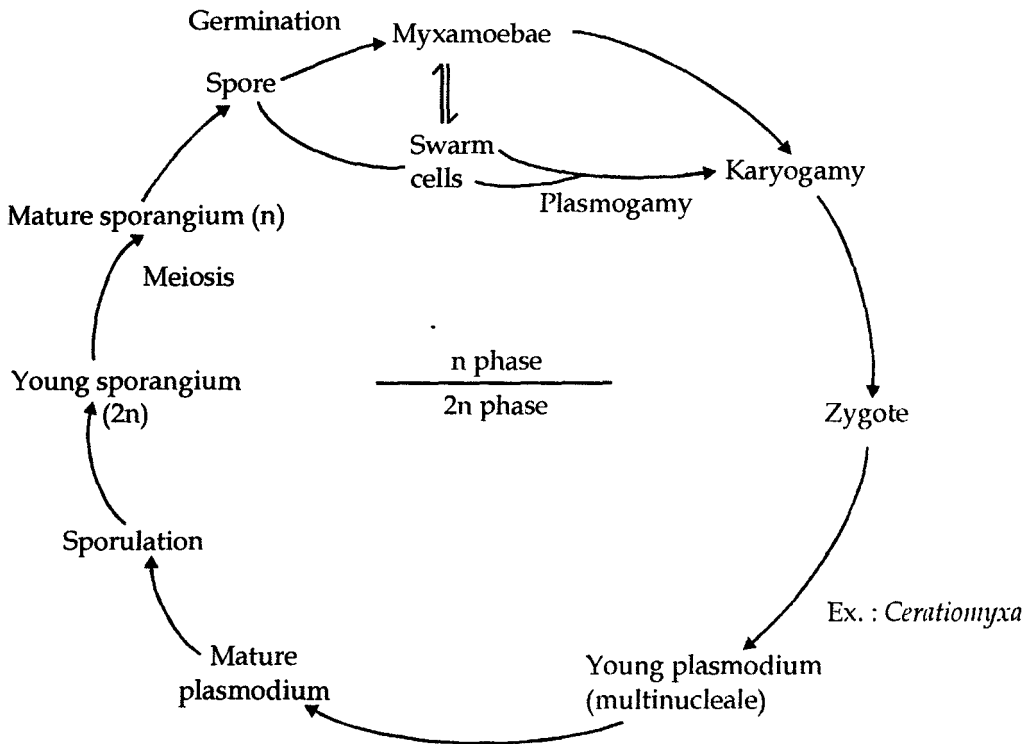

Life cycle of Myxomycetes

7. The numerous spores are differentiated from the diploid protoplast of the sporangium by meiosis.
8. The encapsulated haploid spores or meiospores are close packed between the fine tubes of the capitillitium but are free from them when mature.
9. The spore wall is differentiated into two layers, the outer of which is sculptured or spiny.
10. On germination, the haploid spores or meiospore give rise either to myxamoebae or biflagellate swarm cells which function as gametes.
11. The swarm cells or myxamoebae do not produce slime.
12. The sporangium in *Physarum* thus functions as an organ of sexual reproduction.
13. Sexual reproduction is of isogamous type.
14. The diploid zygote, by repeated mitoses but no cytokinesis, directly gives rise to multinucleate plasmodium.

The term Plasmodium is used for a molded object which is multinucleate surrounded by plasma membrane and a gelatinuous slime sheath with fibrils in it.

Somatic Phase: The creeping multinucleate apparently naked plasmodium which represents the somatic or assimilative phase in the life cycle of myxomycetes, varies in structure in the different species. Alexopoulos (1960) by described three types namely protoplasmodium, aphanoplasmodium and phaneroplasmodium.

1. Protoplasmodium: The plasmodium in some myxomycetes (order Echinosteliales) is simple and of a primitive type. It is a uninucleate tiny mass of nearly homogenous slimy protoplasm which form pseudopode but shows no distinction into veins. It is the smallest among the myxomycetes and remains microscopic as long as it exists. The cytoplasmic stream is indistinct, slow and irregular. At the fruiting time it gets converted into a single sporangium.

2. Aphanoplasmodium: This type of plasmodium is characteristic of the order stemonitomycetales. Early in its development the aphanoplasmodium looks very much like a protoplasmodium. During further growth it elongates and branches, finally resulting in a network of delicate strands. The aphanoplasmodium lacks the slimy sheath. The plasmodial protoplasm is less granular and thus transparent and not easily visible. The distinction into ectoplasm and endoplasm is not conspicuous. The cytoplasmic streaming is, however, rapid and confined by a fine membrane.

3. Phaneroplasmodium: It is the most common type and characteristic of the order physarales. The mature phaneroplasmodium is a massive structure. In its initial stages of development it is very much like the proloplasmodium. The multinucleate slimy protoplasm of the phaneroplasmodium is highly granular. It is differentiated into ectoplasm and endoplasm. At maturity it is divisible into an anterior fan-shaped perforated sheet of protoplasm and posterior zone consisting of a reticulate network of tubular veins or strands in which flows the rapid endoplasmic stream.

Sclerotium formation: Under conditions of stress and strain, the phaneroplasmodium becomes converted into an irregular hardened mass of thick-walled cellular units. It is termed the sclerotium.

The polynucleate thick-walled units constituting the sclerotium are termed spherules. The sclerotia and spherules remain dormant under conditions unfavourable for vegetative growth. With the return of conditions suitable for growth, the sclerodium germinates to give rise to a new plasmodium.

Reproductive phase: Normally on reaching a certain stage of maturity, the Myxomycete plasmodium passes into the reproductive stage. During this stage the entire plasmodium becomes converted into one or more fruit-like bodies, the sporophores or sporangia which bear the spores. This process is termed sporulation. The latter bear spores within sporophores. The sporophores in the endosporus Myxomycetes chiefly are of three types namely sporangia, aethalia and plasmodiocarps.

Sporangia: Most of the endosporous Myxomycetes (order physarales) produce fruit bodies of this type. At the fruiting time the phaneroplasmodium becomes converted into a group of several stalked, sometimes sessile sac-like structures, the sporangia. The sporangia in the group remain separate from one another. However, they arise in close proximity from a common thin transparent cellophane like base called the hypothallus.

The latter is secreted and deposited during conversion of the plasmodium on the portion of the substratum formerly occupied by it. In some cases the hypothallus is absent. Examples are *Arcyria*, *Physarum*, *Trichia*, *Didymium* and others.

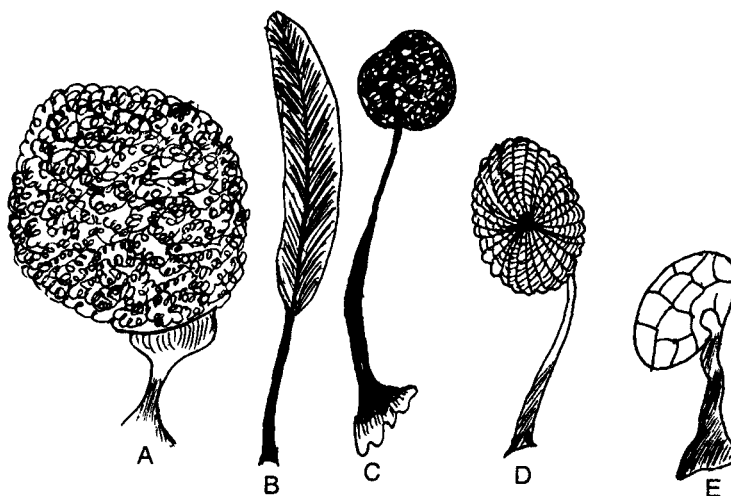

Fig. 5 : Different types of sporangia in slime molds: A. *Arcyria*, B. *Steomonitis*; C. *Comatricha*; D. *Didymium*; E. *Physarum*

Aethalia: Aethalium type of fruit body is characteristic of *Lycogala* and *Fuligo*. The plasmodium, at the fruiting time is fairly large structure. It becomes converted into a group of saclike sporangia that do not separate from one another. The entire fructification which is termed aethalium, is enclosed in a common peridium and share a common hypothallus. The sporangial walls in the aggregation may be distinct, hardly visible or not present at all.

Plasmodiocarp: In forms like *Hemitrichia* the fruit body is very much like a sessile sporangium that retains the shape of the plasmodial venation. This type of sporophore is called a plasmodiocarp. It is formed by the concentration of the plasmodial protoplasm around some of the main veins followed by the development of peridium around cell.

A typical sporophore or sporangium consists of six parts namely hypothallus, stalk, peridium, columella, capillitium and spores. All the sporophores produce spores but may or may not have all the other five parts. Generally the spores are globose in form and have a thick cell wall which is usually sculptured and rarely smooth. The mature spores are uninucleate and haploid. Meiosis occurs in the spores when young.

Classification: Macbride (1899) was the first to use the term myxomycetes. It is group of organism having delicate structure and brilliant colours. They exist in non-green slimy masses of protoplasm sending out pseudopodia. They are found in cold, moist shady places in dead organic matter such as decaying logs and fallen dead leaves in the woods. The class include the true plasmodial acellular slime molds most of which produce pigmented spores in small, delicate sporangia. The class myxomycetes is often divided into the following three sub classes:

(i) **Ceratiomyxomycetidae:** It contains a single order ceratiomyxales represented by a single family ceratiomyxaceae. *Ceratiomyxa* with three exosporus species is the only genus included in this family.

(ii) **Stemonitomycetidae:** It includes a single order stemonitales which comprises only one family stemonitaceae. It is endosporous. The somatic phase is of aphanoplasmodium type.

(iii) **Myxogastromycetidae:** It comprises four orders namely Physarales, Siceales, Echinosteliales and Trichiales. All are endosporous. The somatic phase is usually of protoplasmodial or phaneroplasmodial type. The class myxomycetes thus contains six orders. Of these Physarales belonging to the sub class myxogastromycetidae is the most important.

Systematic Position of Slime Molds

- Members are regarded by many mycologist as parasitic "slime molds". However Gauman (1926), Bessey (1962), Alexopoulos (1962) included these among the true fungi.
- In recent years the controversy has been revitalized by inclusion of plasmodiophoromycetes as a class of myxomycotina (Ainsworth 1966, 1973).
- Klein and Cronquist (1967) suggest that *Woronina* and *Polymyxa* should be separated from plasmodiophorales because of their cellulosic cell wall and zoospore structures.
- Though this group has been included under mastigomycotina we do it with full realization that these organism have no clear cut affinities with any group. They are neither true slime molds nor true fungi. The *Plasmodium* and heterokant zoospores are characters that relate these organism to slime molds but the differences are many:

(a) *Plasmodium* in slime molds is free living while obligately parasite in these organism.

(b) Presence of zoosporangia and resting spores which are not formed by myxomycetes.

(c) Presence of golgi bodies in the *Plasmodium* and in the zoospore relates to Plasmodiophorales with Mastigomycotina. Myxomycetes lack golgi bodies.

(d) Wall is made up of chitin and not cellulose. In myxomycetes the wall of the spores are made up of cellulose.

Until more is known about the site of karyogamy, meiosis and life cycle of these organisms any judgment on their relationship will be only half baked and unprofitable.

THE PROTOZOA

The sub kingdom Protozoa which was originally included in the kingdom protista includes unicellular, non photosynthetic, eukaryotic microorganism that are considered single celled, The Protozoan Animals.

The Protozoa may be defined as 'microscopic, acellular animalcules existing singly

or in colonies without tissues and organs, having one or more nuclei. When in colonies, they differ from metazoa in having all the individuals alike except those engaged in reproductive activities'.

General Characters

1. The protozoans are small, generally microscopic animalcules.
2. Simplest & primitive of all animals with very simple body organisation, i.e. protoplasmic grade of organisation.
3. Acellular, animals, without tissues & organs.
4. Body naked or covered by pellicle but in some forms body is covered with shells and often provided with internal skeleton.
5. Protozoans are solitary or colonial; in colonial forms the individuals are alike and independent.
6. Body shape variable; it may be spherical; oval, elongated or flattened.
7. Body protoplasm is differentiated into an outer ectoplasm and inner endoplasm.
8. Protozoans may have one or more nuclei; nuclei may be monomorphic or dimorphic, vesicular or massive. Vesicular nuclei are commonly spherical, oval or biconvex, consist of a central body, the endosome (nucleolus) encircled by a zone of nuclear sap.
9. Locomotory organelles are pseudopodia, flagella, cilia or none.
10. Nutrition may be holozoic (animal-like), holophytic (plant-like), saprozoic or parasitic. Digestion intracellular, takes place inside the food vacuoles.
11. Respiration occurs by diffusion through general body surface.
12. Excretion occurs through general body surface but in some forms through a temporary opening in the ectoplasm or through a permanent pore, the cytopyge.
13. Contractile vacuoles perform osmoregulation in fresh water forms & also help in removing excretory products.
14. Reproduction asexual or sexual; asexual reproduction occurs by binary fission, multiple fission, budding or sporulation and sexual reproduction is performed by gamete formation or conjugation.
15. Life cycle often exhibits alternation of generation, i.e. it includes asexual and sexual phases.
16. Encystment usually occurs to tide over the unfavourable conditions and it also helps in dispersal.
17. The protozoans exhibit mainly two modes of life, free-living inhabiting fresh water, salt-water and damp places, and parasitic living as ecto & endoparasites. They are also commercial in habit.

Size

The Protozoa are usually microscopic and not visible to the naked eyes. Their size

varies from 2 microns to 250 microns (one micron (μ) is equal to 1/1000 mm or 0.001 mm). *Babesia*, *Leishmania* and *Plasmodium* are the smallest protozoans known so far. Some of the larger protozoa, like *Amoeba* and *Paramecium*, can be seen with naked eyes, *Spirostomum*, a ciliate, grows to 3 mm long. *Pelomyxa*, a giant amoeba, attains a diameter of about 1 to 5 mm. *Porospora gigantea*, a sporozoa, grows to about 16 mm long. *Cycloclypeus*, a foraminifera, exceeds a diameter of about 50 mm and some shelled marine protozoans have diameters of about 63 mm.

Shape

Protozoa, the most primitive of all organisms, exhibit nearly all types of body shape. The body shape of a protozoa is definite but it may usually vary within narrow limits. The body shape is usually determined by the consistency of cytoplasm, limiting membranes of the body, shells & skeleton. *Amoeba* has an irregular, asymmetrical body shape because of the absence of rigid body envelope. However, the floating forms usually possess spherical body shape like *Noctiluca*; the body shape is usually elongated in active swimmers like *Euglena* and *Paramecium*, the body shape may be flattened in creeping forms like *Oxytricha*. Shells and tests like those of *Diffugia* and *Arcella* determine the shape of these species. It may be funnel-shaped like *Stentor*, bell-shaped like *Vorticella* and so on. Some of the protozoans like Radiolarians exhibit spherical symmetry and attached species like *Vorticella* exhibit more or less radial symmetry.

Body Envelope & Skeleton

These protect them from external environmental hazards. The body envelope, being selective in nature, allows exchange of substances across it and helps in perceiving various types of stimuli. However, the body envelope, in protozoans, may be either plasmalemma or pellicle. In some species like *Amoeba proteus*, the body envelope is a thin plasma membrane or plasmalemma which is mucopolysaccharide in nature. It helps in adhesion to the substratum and in the exchange of various materials. The pellicle is comparatively thicker, tough, elastic and porteinous in nature, it helps in maintaining the general shape of the protozoans and performs the usual functions.

The skeletal layers are secreted in still other protozoans in which their protoplasmic body remains protected. These include (a) cyst, (b) theca, (c) lorica and (d) test or shell. It is primarily secreted during unfavourable conditions. The encysted individuals comfortably tide over the environmental hazards. The theca is another skeletal layer found in many dinoflagellates like *Ceratium* & *Glenodinium*. It is a coat of closely-fitted armour of cellulose, comparable to the thick cell walls of higher plants. The lorica, in majority of dinoflagellates, is differentiated into a number of plates arranged into a definite pattern; but in some forms, it may be formed of two valves. The lorica is still another skeletal layer found in certain protozoans like *Salpingoeca*, *Monosiga*, *Dinobryon*, *Synura splendida* and *Poteriodendron*, etc. It is a coat of less-closely fitted armour of protozoans than the theca. The lorica is usually vase-shaped or tubular having an opening for the emergence of the anterior part of the animal or its appendages. The base of the lorica is either attached directly to the substratum (in sessile individuals like *Salpingoeca*) or it may terminate in

a stalk like *Monosiga*. In colonial loricated protozoans, one lorica may be attached to another lorica directly as in *Dinobryon* or one lorica may be attached to another lorica by a stalk as in *Poteriodendron*. The shells or tests are still other skeletal layer of protozoans; these are of common occurrence. There are loose armour with one or more openings over the body of protozoans like *Arcella*, *Diffugia*, etc. In *Arcella* the shell is thin and composed of pseudo-chitin (proteins plus carbohydrates) and ventrally it has an aperture from which 3 or 4 pseudopodia project out. In *Diffugia* the shell is made of sand and other foreign substances like fragments of foraminiferan's shell and sponge spicules. These foreign substances get embedded in a secreted matrix by the animal, working like cement, to form the shell.

Theradiolarian's shells are internal skeletal layer lying between ectoplasm and endoplasm. It forms a central capsule, which is composed of pseudo-chitin or silica or strontium sulphate and secreted by the cytoplasm. The central capsule is perforated by one to many pores through which the extra-capsular cytoplasm extends out as fine pseudopodia.

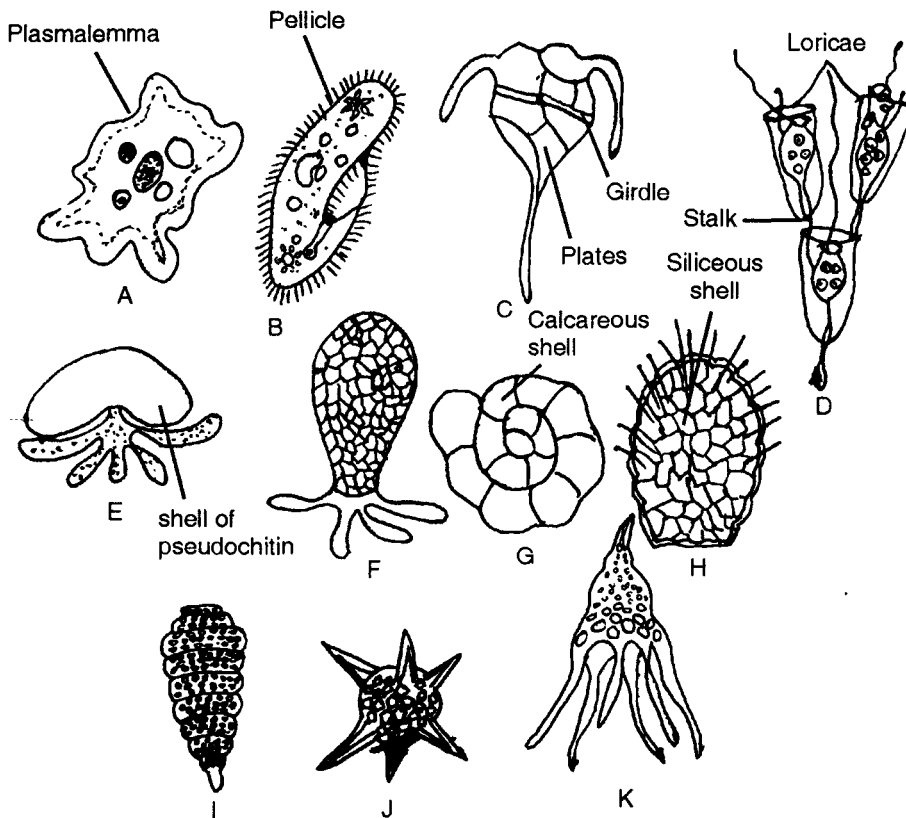

Fig. 6 : Various types of skeletons in protozoa. A. Plasmalemma of *Amoeba*; B. Pellicle of *Paramecium*; C. Thecal plates of *Glenodinium*; D. Lorica of *Poteriodendron*; E. Pseudochitinous shell of *Arcella*; F. Sand grain shell of *Diffugia*; G. Calcareous shell of *Discorbis*; H. Siliceous shell of *Euglypha*; I, J. Radiolarian skeleton showing lattice network; K. Helmet-shaped radiolarian skeleton

Cytoplasm

The cytoplasm of protozoa is generally colorless but certain coloured species are also found; *Blepharisma lateritia* is rose-red and *Stentor coeruleus* is blue. The cytoplasm is commonly divided into peripheral clear ectoplasm and inner granular endoplasm. These two may change from one to the other as is reported in *Amoeba proteus*. The cytoplasm contains various organelles like mitochondria, golgi bodies, endoplasmic reticulum, ribosomes, lysosomes, centrioles, microtubules, plastids, etc.

Nucleus

The nuclei of Protozoa exhibit a greater variety of size, shape and structure than the nuclei of Metazoa. The nucleus of Protozoa has a nuclear membrane, nucleoplasm, oxychromatin, basichromatin, and there may be a nucleolus. The nuclear membrane remains intact even in cell division. There are various kinds of nuclei in protozoa I. Vesicular nucleus has a large amount of nucleoplasm, the chromatin is small in quantity and it forms small granules, the achromatin (oxychromatin) is more fluid and its network, if present, is coarse, there is a round endosome of basichromatin or oxychromatin, or of both e.g., *Euglena*, *Arcella*, *Entamoeba* 2. Massive or computer nucleus has a small amount of nucleoplasm, there is a large amount of chromatin forming evenly scattered small granules, the achromatin is viscid forming a fine network, eg., *Amoeba*. In the majority of protozoa the nuclei show a structure intermediate between the vesicular and massive nuclei. 3 polyenergid nucleus has several sets of chromosomes, instead of one set inside the nuclear membrane, this is due to mitosis occurring repeatedly inside the nuclear membrane. But the sets of chromosomes are finally liberated and each forms a new nucleus. The polyenergid condition is a provision for spore formation, eg., *Radiolaria*.

Locomotion

The Protozoa perform locomotion or movement by various organelles; pseudopodia characteristic of Sarcodina, flagella characteristic of flagellate (Mastigophora), cilia characteristics of Ciliata and other contractile structures of pellicle, myonemes, characteristic of Sporozoa and few others. The seat of locomotion lies in the ectoplasm, since locomotor organelles either arise from it or are present in it.

(A) **Pseudopodia:** Pseudopodia are generally temporary out growths of protoplasm from any part of the body, they are found in those protozoa which are 'naked' or have a very thin pellicle. Pseudopodia may be of ectoplasm or they may also have a core of endoplasm. Following kinds of pseudopodia are found.

(i) Lobopodia are blunt, short or finger-like, they are made of ectoplasm with a core of fluid endoplasm, e.g. *Arcella* & *Amoeba*.

(ii) Filopodia are fine, long threads, often with rounded ends, at times they may branch, they are made of only hyaline ectoplasm, eg. *A. radiosa*-*Radiolaria*.

(iii) Rhizopodia or reticulopodia are thin, long and branching, the branches of adjacent pseudopodia may anastomose to form a network which also serves as a trap for capturing food, eg. *Elphidium*.

(iv) Axopodia are long, stiff threads made of ectoplasm, with a hard central axial filament of endoplasm, unlike others they are semi-permanent, eg. *Actinophrys*, Axopodia are not organelles of locomotion but are only for capturing food.

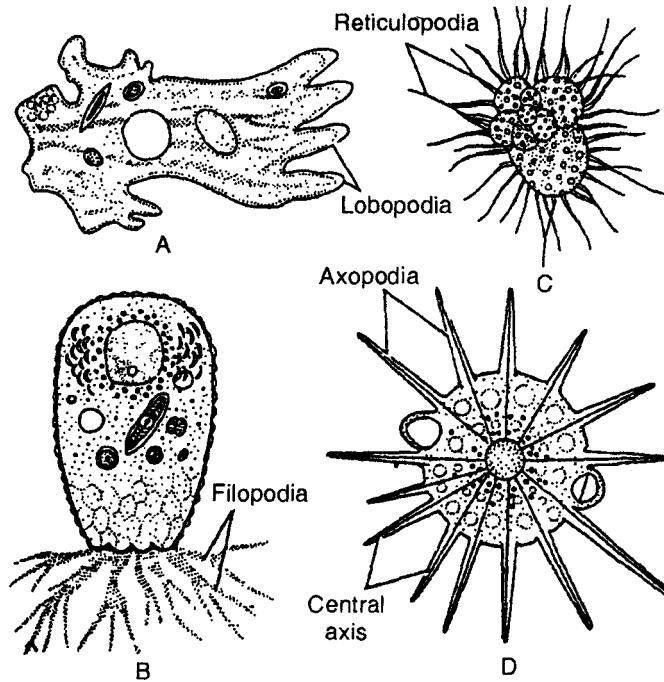

Fig. 7 : Types of pseudopodia. L. Lobopodia of *Amoeba*; B. Filopodia of *Euglypha*; C. Reticulopodia of *Globigerina* D. Axopodia of *Actinophrys*

(B) Flagella: Flagella are extremely fine fibres having a central axoneme made of two longitudinal fibrils, and an enveloping protoplasmic sheath having nine double longitudinal fibrils forming a ring. All 20 fibrils lie in a matrix of dense cytoplasm and they fuse at the base to join a basal granule or kinetosome. The kinetosome may be joined to the nucleus by a rhizoplast. The basal granule is often synonymous with a centriole because it initiates nuclear divisions, if it does not act as a centriole then it is connected by a rhizoplast to a centriole or to the nucleus. At the tip of the main flagellum may be a very fine and piece or mastigoneme, or the main axis of the flagellum may bear fine, flexible lateral processes or mastigonemes on one side or on both sides. Mastigonemes constitute the so-called flimmer or ciliary flagellum. Flagella are recognized to be of the following types depending upon the arrangement of mastigonemes in them:

(i) **Stichonematic:** When the mastigonemes are present on one side of the flagellum; it is called stichonematic flagellum. Eg., Flagellum of *Euglena*.

(ii) **Pantonematic:** When the mastigonemes are present in two or more rows arranged on both the sides of the flagellum, it is called pantonematic, eg., Flagellum of *Paranema*.

(iii) **Acronematic:** When the mastigonemes are absent and the distal end of the flagellum ends in a terminal filament. Eg., flagellum of *Chlamydomonas*.

(iv) **Pentachronematic:** When the mastigonemes are present in two rows on the lateral sides of the flagellum but the flagellum ends in terminal filament, eg., Flagellum of *Urcoelus*.

(v) In some cases, the flagellum is simple without mastigonemes and/or terminal filament, *Chilomonas*, *Cryptomonas*.

(C) **Cilia:** Cilia are exactly like flagella in structure and there is no real distinction between them, except in the method of working. In primitive forms cilia cover the entire body, but in more specialized forms cilia are restricted to certain regions only. Cilia arise from kinetosomes, from each kinetosome arises a rhizoplast which does not join the nucleus, nor do cilia bear any mastigonemes. Running slightly to the right of a longitudinal row of kinetosomes is a delicate thread called kinetodesma. A row of kinetosomes with its kinetodesmata forms a longitudinal unit called kinety, all kinetia of an animal constitute its infraciliary system. Infraciliary system is characteristic of all ciliates, even in those forms in which cilia are lost in the adults the infraciliary system is retained.

Nutrition

Nutrition is a process in which food is taken in, digested, absorbed and assimilated; in fact, it is the process by which the organisms derive their nutrients essential for the growth and maintenance of their life activities. The modes of nutrition vary greatly in Protozoa because of their various mode of living habits. However, in Protozoa, the nutrition is of the following types:

1. Holozoic or Zootrophic

Majority of Protozoa nutritive holozoically, i.e., like animals on solid food. The food of protozoa consists of micro-organism like bacteria, diatoms, rotifers, crustacean larvae, other protozoans, algae, small fragments of large animals and plants, etc. This mode of nutrition essentially involves the processes like intake of food, i.e., ingestion, digestion, absorption and egestion of undigested residues.

(a) **Ingestion:** The mode of food ingestion in Protozoa is characteristically referred to as phagocytosis or phagotrophy. In fact, in flagellates which are colourless or who have lost their chromatophores capture food with the help of their flagella. The captured food is ingested either at definite sites on their naked bodies like *Bodo* or through characteristic oral apparatus like *Euglena* where cytostome and cytopharynx help in ingestion. In some other flagellates like *Peranema*, special rod-like structures called trichites help in capturing the food. In *Sarcodina*, pseudopodia help in food capturing by forming food cups.

(b) **Digestion:** Digestion in Protozoa is intracellular within food vacuoles. The food vacuoles undergo changes in pH and in their size during digestion. At first the contents of the food vacuole are acidic and the vacuoles decrease in size, during this phase living prey dies. After the initial acid phase the cytoplasm of the protozoan produces enzymes in an alkaline medium, the enzymes pass into the food vacuoles and the vacuoles increase in size and become alkaline. Then the contents of the vacuoles are digested. In fact, proteolytic and carbohydrate digesting enzymes are reported in Protozoa; the proteins are

converted into dipeptides in acidic medium and the dipeptides into amino-acids in alkaline medium. The carbohydrates are hydrolysed in alkaline medium. The fat digesting enzymes have also been reported in some Protozoa.

(c) **Absorption and assimilation:** The digested food from the food vacuole is diffused out into the endoplasm and finally assimilated in the body to manufacture the protoplasm. The excess of food is stored in form of glycogen paramylon, paraglycogen bodies in the endoplasm.

(d) **Egestion:** The undigestible remains of the food are egested out from the body at any body surface, eg., in *Amoeba*. But ciliates possess a definite opening for the egestion of undigested remains called cytoproct or cytopyge.

2. Pinocytosis

Pinocytosis or cell-drinking has also been reported in some Protozoa like *Amoeba proteus*, and also in certain flagellates and ciliates. It is related to the ingestion of liquid food by invagination of the general body surface. It may occur at any part of the body; during pinocytosis, some pinocytic channels are formed from the outer body surface deep into the body. The inner ends of these channels contain pinocytic vesicles or pinosomes which get separated after engulfing liquid food through the channels. The separated pinosomes become the food vacuoles. This process is induced in presence of certain salts and some proteins.

3. Autotrophic or Holophytic Nutrition

Protozoa with chlorophyll or some allied pigment can manufacture complex organic food, like those of green plants, from simple inorganic substances, e.g., *Euglena*, *Noctiluca*. Often there may be protein bodies called pyrenoids which are the centres of photosynthesis. Some protozoa have no chromatophores but they have chlorophyll-bearing algae *Zooxanthellae* or *Zoochlorellae* which manufacture organic food for the host by photosynthesis, e.g., *Stentor*, *Paramecium bursaria*. Nitrates or ammonium compounds are sufficient as the source of nitrogen for autotrophic forms.

4. Saprozoic Nutrition

Some Protozoa absorb complex organic substances in solution through the body surface by the process of osmosis called osmotrophy. These protozoa are called saprozoic. Saprozoic forms need ammonium salts, amino acids, or peptones for their nutritional requirements. Decaying of animals and plants in water forms protein and carbohydrates. The saprozoic Protozoa are usually parasites like *Monocystis*.

5. Parasitic Nutrition

The parasitic forms feed either holozoically or saprozoically. Thus, the parasites may be grouped into two categories on the nature of food and their mode of feeding:

(i) **Food – robbers:** The parasites feeding upon the undigested or digested food stuffs of their hosts are known as food-robbers, such as some ciliate parasites like *Nyctotherus*, *Balantidium*.

(ii) **Pathogenic:** The protozoan parasites causing harm to their hosts, usually feed upon the living tissues of the host. They absorb liquid food through their general body surface eg., *Trypanosoma*, *Plasmodium*, etc.

6. Coprozoic Nutrition

Certain free-living protozoans are in habit of feeding upon the faecal matters of the other organisms like *Clamydophrys* and *Dimastigamoeba*.

7. Mixotrophic Nutrition

Some protozoa nourish themselves by more than one method at the same time or at different times due to change in environment. This is called mixotrophic nutrition, e.g., *Euglena gracilis* and *Peranema* are both saprozoic and autotrophic in their nutrition, and some flagellates are both autorrophic and zootrophic.

REPRODUCTION

The mode of reproduction in protozoa is highly variable among different group although it is primarily a cell division. Protozoa reproduce both asexually and sexually.

Asexual Reproduction

1. Equal or binary fission: Equal or binary fission takes place for reproducing and also for gamete formation. Usually there is a centriole within the nucleus, but unlike metazoa no asters are formed, moreover the nuclear membrane persists intact during division in most Protozoa. The nucleus elongates and divides amitotically into two parts which travel apart, then the cell constricts in the middle to form two daughter cells. Macronuclei of ciliates divide amitotically. Binary fission is simple in Sarcodina like Amoeba where the plane of division is not definite and it is usually transverse in ciliates like *Paramecium* but in most flagellates like *Euglena* it is longitudinal in which the nucleus elongates transversely, but the cell divides length wise, while binary fission is oblique in certain cases like *Ceratium*. In binary fission (in flagellates) a single flagellum is retained usually by one daughter cell, and the basal granule divided into two, the new basal granule forms a flagellum in the other daughter cell. When there are many flagella they are distributed among the daughter cells which grow new flagella to complete the number. Cilia are shared by daughter cells and new cilia are formed by kinetosomes to complete the number. Chromatophores usually divide but contractile vacuoles rarely divide, they are generally shared or are made anew. Complex organelles are destroyed and then re-made in the daughter cells.

2. Multiple Fission: The nucleus divides repeatedly without division of the cytoplasm, later the cytoplasm separates into as many parts as there are nuclei, usually some residual cytoplasm is left unsegmented. If multiple fission produces four or more young ones by equal cell division, and the young ones do not separate till the process is completed, then such cell division is spoken of as repeated fission, e.g., *Vorticella*. Multiple fission produces small cells which may grow into adults or they may become gametes which require fertilization to form sporozoites (*Plasmodium*). The multiple fission may lead either to asexual or sexual reproduction.

3. Plasmotomy: An asexual division of a multinucleate animal in which the cytoplasm divides but the nuclei do not is called plasmotomy (*Opalina*, *Pelomyxa*). Later each daughter cell regains the normal number of nuclei by nuclear division.

4. Budding: An unequal division of the parent body produces one or more buds which may separate from the parent, the nucleus of the bud is a part of the parent nucleus, e.g., *Arcella*. The bud is smaller than the parent; the buds may grow into adults or may become gametes. When buds are formed on the surface of the parent, then this is known as exogenous budding, e.g., *Noctiluca* produces hundreds of buds on its surface as small protuberances. When the buds are formed inside the cytoplasm and may remain within the parent, then the process is called endogenous budding, e.g., *Arcella*. Endogenous budding may be a method of asexual reproduction or it may bring about formation of gametes, eg., *Arcella* becomes multinucleate, protoplasm collects around the nuclei to form many amoebulae which escape from the parent and grow into adults.

5. Parthenogenesis: Parthenogenesis is the ability of the gametes to develop into adults without fertilization by gametes of the opposite sex, the gamete possessing this power is almost always the female one, e.g., in *Actinophrys* two individuals get enclosed in a cyst, each divides to form two gametes, one gamete of an individual conjugates with a gamete of the other individual, the remaining gamete of each individual develops parthenogenetically into an adult. Thus, gametes which have been unable to undergo cross fertilization develop by parthenogenesis. Potential gametes of *Chlamydomonas* will grow and divide to become adults when they have missed syngamy. Endomixis of ciliates is also a parthenogenetic phenomenon. The chromosome condition in parthenogenesis may be expected to be haploid since no fertilization occurs, but it is generally diploid.

6. Regeneration: Regeneration is the capacity to form new tissues to replace a lost part, this capacity varies inversely with the complexity of an organism. In protozoa any nucleated portion is capable of regeneration, while non-nucleated portions are not, e.g., *Stentor* has a long chain-like nucleus, if the animal is cut transversely into say three parts, then each piece having a portion of the nucleus will regenerate the missing portions and three *Stentors* will be formed.

Sexual Reproduction

Sexual reproduction occurs by the following methods in Protozoa:

1. Syngamy or copulation: Syngamy is the union and complete fusion of two gametes of the same species. If the two gametes are identical morphologically, though they may be different physiologically, then they are isogametes and their syngamy is isogamy (*Monocystis*). If the gametes differ in size and morphology, then they are anisogametes and their syngamy is anisogamy (*Plasmodium*). The smaller, usually numerous and motile gametes are male or microgametes; the larger, generally few and inactive gametes are female or macrogametes. Meiosis or reduction division occurs generally in the formation of gametes, but in many flagellates meiosis is post-zygotic, that is, it occurs after the formation of the zygote. The fusion of two gametes produces a zygote, its nucleus is formed by the fusion of nuclei of gametes, and it is called a synkaryon. The zygote may develop directly into an adult, or it may encyst and undergo multiple fission. Syngamy whether isogamous or anisogamous is always exogamous, that is, the fusing gametes come from different parents, hence, sex distinction may be said to exist in Protozoa, though sexes may not be distinguished.

2. Conjugation: Conjugation is a temporary union of two Protozoa of the same species for an exchange of nuclear material without the fusion of their cytoplasm, e.g. in *Paramecium caudatum*. In ciliates there is no formation of distinct gametes.

A sexual process somewhat intermediate between syngamy & conjugation occurs in *Vorticella* in which one individual forms one to four microgametes by repeated fission, and the other individual forms a macrogamete by nuclear modification, the macrogamete is a hologamete because it is not formed by fission. Thus, *Vorticella* shows sexual dimorphism in its gametes, a microgamete fuses with a macrogamete to form a zygote. The zygote by three divisions produces seven cells which grow into adults.

In both syngamy and conjugation there is a rejuvenation of the animal by replacement of the macronucleus with material from the synkaryon, both processes produce new types of individuals by combination of genes, hence they give the race a better chance of survival.

3. Automixis: In some Protozoa the nucleus divides into two, the two nuclei fuse together, this is called automixis. If the two nuclei which fuse are present in a single cell, then the process is called autogamy, but if the two fusing nuclei are present in two different cells, then the process is known as paedogamy. Autogamy occurs in a single *Paramecium aurelia* which provides both the fusing nuclei to form a synkaryon. Paedogamy occurs in *Actinosphaerium* and *Actinophrys* in which two cells of a secondary cyst and their two remaining nuclei fuse to form a zygote which reproduces by binary fission.

Sexual reproduction of Protozoa differs from the sexual reproduction of metazoa in that the protozoan is both somatic and gametic. For many generations there is a somatic phase in which binary fission occurs, then one generation is gametic in which syngamy or conjugation takes place. The function of binary fission is reproduction or increasing the number of individuals, and the function of syngamy or conjugation is rejuvenation, but not reproduction although it is called 'Sexual reproduction'. In the life cycle of some protozoa binary fission alternates with syngamy, this alternation may have regular sexual and asexual generations (*Elphidium*), but more usually binary fission is repeated for many generations continuously, and it is broken only occasionally by syngamy or conjugation. Probably the occasional conjugation occurs only when the physiological condition of the animal becomes different from normal (*Paramecium*).

4. Endomixis: It is a type of nuclear reorganization which usually occurs when conjugation is prevented. In this case fusion of pro-nuclei does not take place. But the macronucleus is reorganized from micronuclear material. The reorganized macronucleus accelerates the metabolic activities of the individual and helps in the renewal of the vigour as is reported in *Paramecium aurelia*.

5. Hemixis: It has been reported in the various species of *Paramecium* like *P. caudatum*, *P. aurelia* and *P. multimicronucleatum*. In this case, the macronucleus throws away its many fragments of different sizes in the cytoplasm which are absorbed in it. The left out part of macronucleus, then starts behaving in a normal way and becomes the fresh macronucleus. The micronucleus, however, plays no part in hemixis and remains inactive and unchanged during this process.

Parasitism in Protozoa

The relationship between two organisms may be symbiosis, commensalisms, or parasitism.

Symbiosis is a relationship in which there is reciprocal benefit between one animal called a symbiont and the other called a host, the symbiont lives in the body of the host, e.g., *Trichonympha* lives in the gut of termites in symbiotic relationship, *Trichonympha* obtains food & lodging, & in return it digests the wood eaten by termites, the termites are incapable of digesting wood.

Commensalism is an association in which one organism called a commensal is benefited, & the other organism known as the host is neither benefited nor harmed, eg., *Nyctotherus* is cockroach gets food from the host, but the host is not injured in any way. The distinction between symbiosis & commensalisms is not very sharp; *Entamoeba coli* in man is usually a commensal, but it may become symbiotic when it eats up bacteria which may be harmful to man.

Parasitism is an association in which one organism, the parasite lives on the body or inside the body and at the expense of another organism known as the host. Parasitic mode of life is a secondary state, the parasites having arisen frequently and independently from free-living ancestors. The relationship of a parasite to its host is of varying degrees of intimacy, the parasite may be epizoic or endozoic.

The Flagellate Protozoa: The Mastigophora

The Mastigophora are protozoa that always bear flagella as the locomotor organelles. In contrast to the ciliates, in which cell division is transverse, flagellate protozoa undergo longitudinal division. This mode of division has already been described for a photosynthetic flagellate, *Euglena*. In addition to leucophytes, this protozoan group includes many representatives that show no resemblance to photosynthetic flagellates and are for the most part parasites of animals.

The trypanosomes are frequently parasitic in vertebrates, where they develop in the bloodstream, being transmitted from host to host by the bite of insects. The cell is slender and leaf-shaped, its single flagellum being directed posteriorly and attached through part of its length to the body of the cell, to form an *undulating membrane*. The trypanosomes are osmotrophic protozoa, which absorb their nutrients from the blood of the host.

Other parasitic flagellates inhabit the gut of vertebrates or invertebrates. The trichomonads, which have four to six flagella are harmless inhabitants of the gut of vertebrates.

The Amoeboid Protozoa: The Rhizopoda

The Rhizopoda are protozoa in which ameboid locomotion is the predominant mode of cell movement, although some of them are able to produce flagella as well. The simplest members of this group are amebae, which have characteristically amorphous cells as a result of the continuous changes of shape brought about by the extension of pseudopodia.

Most amebae are free-living soil or water organisms that phagocytize smaller prey. A few inhabit the animal gut, including forms that cause disease (amebic dysentery). Other members of the Rhizopoda have a well-defined cell form, as the result of the formation of an exoskeleton or shell (typical of the foraminifera) or an endoskeleton (typical of the heliozoan and radiolaria).

The Ciliate Protozoa: The Ciliophora

The ciliate protozoa are a very large and varied group of aquatic, phagotrophic organisms that are particularly widely distributed in fresh water. The ciliates share a number of fundamental cellular characters that distinguish them sharply from all other protists. This suggests that despite the very great internal diversity of this group, it is one class of protozoa that may have had a single common evolutionary origin.

At some time in the life history, the cell is motile by means of numerous short, hair-like projections, structurally homologous with flagella, which are termed *cilia*. Each cilium arises from a basal structure, the kinetosome, which is homologous with the kinetosome of a flagellum; however, in ciliates the kinetosomes are interconnected by rows of fibrils called *kinetodesmata* to form very elaborate compound locomotor structures termed kineties. This internal system persists, even if the cell is devoid of cilia.

CLASSIFICATION

The classification followed here is given by the committee on Taxonomy & Taxonomic problems of the society of protozoologists (Honigberg *et al.* 1964). According to Honigberg *et al.*, (1964) Protozoa have been classified into four subphyla.

Sub Phylum 1

Sarcomastigophora

1. Organelles of locomotion are pseudopodia or flagella.
2. Nucleus is of single type (monomorphic).
3. There is no spore formation.
4. Syngamy occurs in reproduction.

Super class

A. Mastigophora

1. They are commonly called flagellates.
2. Organelles of locomotion in adults are flagella.
3. Body is covered by pellicle.
4. Binary fission is longitudinal.
5. They are mostly free-living though some are parasitic.

Class 1 Phytomastigophora

1. They generally possess chromatophores.

2. There are usually only one or two flagella.

3. The nucleus is vesicular.

Order 1 Chrysomonadina

Examples: *Chromulina, Ochromonas, Chrysamoeba*

Order 2 Coccolithophorida

Examples: *Coccolithus, Rhabdosphaera.*

Order 3 Heterochlorida

Examples: *Heterochloris, Myxochloris*

Order 4 Cryptomonadida

Examples: *Chilomonas, Cryptomonas*

Order 5 Dinoflagellida

Examples: *Noctiluca, Ceratium*

Order 6 Euglenida

Examples: *Euglena, Peranema*

Order 7 Volvocida

Examples: *Volvox, Eudorina*

Class 2 Zoomastigophora (Zoomastigina)

1. They have no chromatophores.

2. There are one to many flagella.

3. Often there is an undulating membrane.

4. Most of them are parasitic.

Order 1 Choanoflagellida

Example: *Proterospongia*

Order 2 Rhizomastigida

Examples: *Mastigamoeba, Dimorpha*

Order 3 Hypermastigida

Examples: *Trichonympha, Leptomonas*

Order 4 Diplomonadida

Examples: *Giardia, Hepamita*

Order 5 Kinetoplastida

Sub order 1. Bodonina

Example: *Bodo*

Sub order 2 Trypanosomatina

Examples: *Trypanosoma, Leishmania*

Order 6 Bicosoecida

Examples: *Salpingoeca*, *Poteriodendron*

Order 7 Retortamonadina

Example: *Chilomonas*

Order 8 Oxymonadina

Examples: *Oxymonas*, *Pyrsonympha*

Order 9 Trichomonadina

Example: *Trichomonas*

Super class B Opalinata

1. They have numerous cilia-like organelles in oblique rows over the entire body surface.
2. There is no cytostome.
3. Binary fission is interkinetal.
4. There is syngamy with flagellated gametes.
5. All are parasitic.

Example: *Opalina*

Super class C. Sarcodina

1. Their organelles of locomotion are pseudopodia.
2. The amoeboid form is predominant.
3. Some have a hard shell.
4. They generally do not form spore.
5. Formation of gametes and flagellated young ones are common.

Class 1 Rhizopodea

1. Their organelles of locomotion are pseudopodia or filopodia but never axopods.
2. They are generally creeping forms.

Sub Class (i) Lobosia

1. Pseudopodia are typically lobose rarely filiform or anastomosing.

Order (1) Amoebida

Examples: *Amoeba*, *Pelomyxa*, *Entamoeba*

Order (2) Arcellinida

Examples: *Arcella*, *Diffugia*

Sub class (ii) Filosia

1. They have tapering and branching filaments rarely anastomosing.

Examples: *Gromia*, *Allogromia*

Sub class (iii) Granuloreticulosia

1. They have finely granular reticulose podia (reticulopodia).

Order (1) Foraminiferida**Examples:** *Globigerina*, *Elphidium***Sub class (iv) Mycetozoa**

1. The amoeboid trophic stage develops either into a multicellular aggregation or into a true multinucleate plasmodium.
2. Life cycle complex & has sexual reproduction.
3. Usually sporangia are formed which liberate spores.
4. Nutrition is phagocytic.

Example: *Plasmodiophora***Class 2 Piroplasmea**

1. Small, round, rod-shaped or amoeboid parasites in vertebrate red blood cells.

Example: *Babesia***Class 3 Actinopodea**

1. Their organelles of locomotion are delicate and radiose axopodia.
2. They are primarily sessile or floating forms.
3. Test is present or absent.
4. Gametes are usually flagellated.
5. Reproduction is both sexual and asexual.

Sub class 1 Radiolaria

1. Central capsule is perforated by one to many pores.
2. They have spicules or a siliceous skeleton.
3. Filopodia or axopodia are present.
4. The capsule separates the protoplasm into ectoplasm & endoplasm.
5. All are marine.

Examples: *Thalassicola*, *Collozoum*, *Lithocircus***Sub class 2 Acantharia**

1. Imperforate, non-chitinoid central capsule without pores.
2. Anisotropic skeleton of strontium sulphate.
3. Axopodia
4. Marine

Example: *Acanthometra***Sub class 3 Heliozoia**

1. There is no central capsule.
2. Rounded body with radiating axopodia.
3. Usually naked, if a skeleton is present it is made of siliceous scales and spines.

4. They have axopodia or filopodia.
5. There may be more than one nucleus, mostly in fresh water.

Examples: *Actinophrys*, *Actinosphaerium*, *Clathrulina*

Sub class 4 Proteomyxidia

1. Largely marine and freshwater parasites of class and higher plants.
2. Filopodia and reticulopodia in some species.

Examples: *Vampyrella*

Sub Phylum II. Sporozoa

1. The adult has no external organelles of locomotion.
2. They are all parasitic and incapable of active life outside their hosts.
3. Cilia or flagella may be present in gametes.
4. Syngamy takes place after which many spores are formed.
5. The spores are simple and contain one to many sporozoites.
6. Sporozoites are the infective phase.
7. Nucleus is of the single type.

Class 1 Telosporea

1. Pseudopodia are generally absent & locomotion is by gliding or body flexion.
2. Spores are formed & there are flagellated microgametes in some.
3. Reproduction is both sexual & asexual.

Sub class I Gregarina

1. Mature trophozoites are large and extracellular.
2. Reproduction is entirely sexual with sporogony.
3. The spores contain eight sporozoites.
4. They are parasites in the digestive tract and body cavity of invertebrates.

Examples: *Gregarina*, *Monocystis*, *Nematocystis*

Sub class 2 Coccidia

1. Mature trophozoite is small & typically intracellular.
2. Being parasitic in the digestive tract or blood.
3. Gametocytes are dimorphic.
4. Sporozoites multiply by schizogony in tissue cells.

Order (a) Eucoccida

1. Schizogony takes place.
2. There are both sexual & asexual phases in the life cycle.
3. They are parasitic in epithelial and blood cells of invertebrates and vertebrates.

Sub order 1 Eimeriina**Examples:** *Eimeria***Sub order 2 Haemosporina****Examples:** *Plasmodium***Class 2 Toxoplasmea**

1. Spores are absent.
2. There are no flagella or pseudopodia at any stage.
3. Reproduction by binary fission.
4. Cysts are formed which have many naked sporozoites.

Examples: *Sarcocystis, Toxoplasma***Class 3 Haplosporea**

1. Spores are present.
2. Pseudopodia may be present but flagella are absent.
3. Reproduction is only asexual & schizogony takes place.

Examples: *Caelosporidium, Ichthyosporidium***Sub Phylum III Cnidospora**

1. Spores have several cells having one or more polar filaments which are coiled threads and can be shot out, and one or more sarcoplasma or sporoplasma.

2. All are parasitic.
3. Zygote gives rise to one or more trophozoites without sporogony.

Class 1 Myxosporidea

1. Spores are of multicellular origin.
2. There are one or more sporoplasms, with two or three valves.
3. They are parasitic in fishes.

Examples: *Myxobolus, Ceratomyxa***Class 2 Microsporidea**

1. Spores are of unicellular origin.
2. There is one long tubular polar filament through which the sporoplasm emerges, one valve only.

Sub Phylum IV. Ciliophora

1. All possess simple ciliary organelles for locomotion, infraciliature is subpeculiar.
2. They have two nuclei, a trophic macronucleus and a reproductive micronucleus.
3. Binary fission is perkinetal.
4. Conjugation takes place with fusion of nuclei, autogamy and cytogamy also occur.

5. There are never any free gametes.
6. Nutrition is mixotrophic or heterotrophic.
7. They usually have a cytostome.

Class 1 Ciliata

1. All possess cilia or compound ciliary structure as locomotor or food acquiring organelles at some time in the life cycle.
2. Also present is an infraciliary system, composed of basal granules below the cell surface and interconnected by longitudinal fibrils.
3. Most ciliates possess a cell mouth or cytostome.
4. Two types of nuclei, one vegetative (macro-nucleus) and the other reproductive (micronucleus).
5. Fission is transverse.
6. Sexual reproduction never involves the formation of free gametes.

Sub class I. Holotrichia

1. With simple or uniform body cilia.
2. Buccal ciliature either absent or, if present, usually inconspicuous.

Order 1 Gymnostomatida

Examples: *Coleps*, *Dileptus*, *Didinium*

Order 2 Trichostomatida

Examples: *Colpoda*, *Balantidium*

Order 3. Chonotrichida

Examples: *Spirochona*, *Chilodochona*

Order 4. Apostomatida

Examples: *Nassula*

Order 5 Astomatida

Examples: *Anoplophyra*, *Hoplitophyra*

Order 6 Hymenostomatida

Examples: *Colpidium*, *Tetrahymena*, *Paramecium*

Order 7 Thigmotrichida

Examples: *Thigmophrya*, *Boveria*

Sub Class II Peritrichia

Order 1 Peritrichida

Examples: *Vorticella*, *Trichodina*

Sub Class III Suctoria

Order 1 Suctorida

Examples: *Acineta*, *Ephelota*

Sub Class IV Spirotrichia

1. With generally reduced body cilia.
2. Well developed conspicuous buccal ciliature.

Order 1 Heterotrichida

Examples: *Bursaria*, *Stentor*, *Spirostomum*, *Nyctotherus*

Order 2 Oligotrichida

Example: *Halteria*

Order 3 Tintinnida

Examples: *Codonella*, *Favella*

Order 4 Entodiniomorphida

Examples: *Entodinium*, *Cycloposthium*

Order 5 Odontostomatida

Example: *Saprodinium*

Order 6 Hypotrichida

Examples: *Euplotes*, *Stylonychia*, *Urostyla*, *Oxytricha*

APPENDIX 1

Prokaryotes Notable for their Environmental Significance

Group/Genera	Characteristics
Metabolic Diversity	
Anaerobic Chemolithotrophs	
Methanogens <i>Methanococcus, Methanospirillum</i>	Members of the Archaea that oxidize hydrogen gas, using CO ₂ as a terminal electron acceptor to generate methane.
Anaerobic Chemoorganotrophs- Anaerobic Respiration	
Sulfur-and sulfate-reducing bacteria <i>Desulfovibrio</i>	Use sulfate as a terminal electron acceptor, generating hydrogen sulfide. Found in anaerobic muds that are rich in organic material. Gram-negative.
Anaerobic Chemoorganotrophs- Fermentation	
<i>Clostridium</i>	Endospore-forming obligate anaerobes. Common inhabitants of soil. Some species are medically important. Gram-positive.
Lactic acid bacteria	
<i>Streptococcus, Enterococcus, Lactococcus, Lactobacillus, Leuconostoc Propionibacterium</i>	Produce lactic acid as the major end product of their fermentative metabolism. Although most can grow in the presence of O ₂ , they can only ferment. Several genera are exploited by the food industry; some species are medically important. Gram-positive. Obligate anaerobes that produce propionic acid as their primary fermentation end product. Used in the production of swiss cheese. Gram-positive.
Anoxygenic Phototrophs	
Purple sulphur bacteria	
<i>Chromatium, Thiospirillum, Thiodictyon</i>	Grow in coloured masses in sulfur springs and other sulfur-rich habitats, using sulfur compounds as a source of electrons when making reducing power. Most accumulate sulfur granules contained within the cell. Gram-negative.
Purple non-sulphur bacteria	
<i>Rhodobacter, Rhodospseudomonas</i>	Grow in a wide variety of aquatic habitats, preferentially using organic compounds as a source of electrons for reducing power. Many are metabolically versatile. Gram-negative.
Green Sulphur bacteria	
<i>Chlorobium, Pelodictyon</i>	Found in habitats similar to those preferred by the purple sulfur bacteria. Those that accumulate sulfur form granules outside of the cell. Gram-negative.
Green non-sulphur bacteria	
<i>Chloroflexus</i>	Characterized by their filamentous growth. Metabolically similar to the purple non-sulfur bacteria. Gram-negative.
Others	
<i>Heliobacterium</i>	Other types of anoxygenic phototrophs have not been studied extensively.
Oxygenic Phototrophs – Cyanobacteria	
<i>Anabaena, Synechococcus, Trichodesmium</i>	Photosynthetic bacteria that were once thought to be algae. Important primary producers. Those that fix N ₂ , support the growth of unrelated organisms in environments that would otherwise be nitrogen-deficient. Gram-negative.
Aerobic Chemolithotrophs	
Filamentous sulfur oxidizers	Oxidize sulfur compounds as an energy source. Found in sulfur

Contd...

...Contd.

Group/Genera	Characteristics
<i>Beggiatoa, Thiothrix</i>	springs, sewage-polluted waters, and on the surface of marine and freshwater sediments. Their overgrowth causes bulking in sewage at treatment facilities. Gram-negative.
Unicellular sulfur oxidizers <i>Thiobacillus</i>	Oxidize sulfur compounds as an energy source. Some species can produce enough acid to lower the pH to 1.0. Oxidation of metal sulfides causes bioleaching. Gram-negative.
Nitrifiers <i>Nitrosomonas, Nitrosococcus,</i> <i>Nitrobacter, Nitrocooccus</i>	Oxidize ammonia or nitrate as an energy source. In so doing, they convert certain fertilizers to a form that is readily leached from soils, and deplete O ₂ in waters polluted with ammonia-containing wastes. Genera that oxidize nitrite prevent the toxic buildup of this compound in soils. Gram-negative.
Hydrogen-oxidizing bacteria <i>Aquifex, Hydrogenobacter</i>	Thermophilic bacteria that oxidize hydrogen gas as an energy source. According to 16S rRNA studies, they were one of the earliest bacterial forms to exist on earth.
Aerobic Chemoorganotrophs – Obligate Aerobes <i>Micrococcus</i>	Widely distributed, common contaminants on bacteriological media. Gram-positive
<i>Mycobacterium</i>	Waxy cell wall resists staining; acid-fast. Some species are medically important.
<i>Pseudomonas</i>	Common environmental bacteria that, as a group, can degrade a wide variety of compounds. Some species are medically important. Gram-negative.
<i>Thermus</i>	<i>Thermus aquaticus</i> is the source of <i>Taq</i> polymerase, the heat-resistant polymerase used in PCR. Unusual cell wall stains gram-negative.
<i>Deinococcus</i>	Extraordinarily resistant to the damaging effects of gamma radiation. Unusual cell wall stains gram-positive, but has multiple layers.
Aerobic Chemoorganotrophs- Facultative Anaerobes <i>Corynebacterium</i>	Widespread in nature; form metachromatic granules. Some species are medically important. Gram-positive.
The Enterobacteriaceae <i>Escherichia coli, Enterobacter,</i> <i>Klebsiella, Proteus, Salmonella,</i> <i>Shigella, Yersinia</i>	Most reside in the intestinal tract. Those that ferment lactose are coliforms; their presence in water serves as an indicator of fecal pollution. Some species are medically important. Gram-negative.
ECOPHYSIOLOGY Thriving in Terrestrial Environments	
Endospore-formers <i>Bacillus, Clostridium</i>	Endospores are the most resistant life form known. <i>Bacillus</i> species include both obligate aerobes and facultative anaerobes; <i>Clostridium</i> species are obligate anaerobes. Some species are medically important. Gram-positive.

Contd...

...Contd.

Group/Genera	Characteristics
<i>Azotobacter</i>	Form a resting stage called a cyst. Notable for their ability to fix nitrogen in aerobic conditions. Gram-negative.
Myxobacteria <i>Chondromyces, Myxococcus, Stigmatella</i> <i>Streptomyces</i>	Congregate to form a fruiting body; cells within this differentiate to form dormant microcysts. Gram-negative.
<i>Agrobacterium</i>	Resemble fungi in their pattern of growth, forming dormant conidia. Naturally produce a wide array of medically useful antibiotics. Gram-positive.
Rhizobia <i>Rhizobium, Sinorhizobium, Bradyrhizobium, Mesorhizobium, Azorhizobium</i>	Cause plant tumors. Scientists use their plasmid to introduce desired genes into plant cells. Gram-negative. Fix nitrogen, form a symbiotic relationship with legumes. Gram-negative.
Thriving in Aquatic Environments	
Sheathed bacteria <i>Sphaerotilus, Leptothrix</i>	Form chains of cells enclosed within a protective sheath. Swarmer cells move to new locations. Gram-negative.
Prosthecate bacteria <i>Caulobacter, Hyphomicrobium</i>	Appendages increase their surface area. <i>Caulobacter</i> species serve as a model for cellular differentiation. <i>Hyphomicrobium</i> species have a distinctive method of reproduction. Gram-negative.
<i>Bdellovibrio</i>	Predator of <i>E. coli</i> and other bacteria, multiplying within the periplasm of the prey. Gram-negative.
Bioluminescent bacteria <i>Photobacterium, Vibrio fischeri</i> <i>Legionella</i>	Some bioluminescent species form a symbiotic relationship with specific-species of squid and fish. Often reside within protozoa. Some species are medically important. Gram-negative.
Free-living spirochetes <i>Spirochaeta, Leptospira</i> (some species) <i>Magnetospirillum</i>	Long spiral-shaped bacteria that move by means of an axial filament. Some species are medically important. Gram-negative. Contain a string of magnetic crystals that enable them to move up or down in water and sediments. Gram-negative.
<i>Spirillum</i>	Spiral-shaped, microaerophilic bacteria, some species form metachromatic granules. Gram-negative.
Sulfur – oxidizing, nitrate-reducing marine bacteria <i>Thioploca, Thiomargarita</i>	Use novel mechanisms to compensate for the fact that their energy source (reduced sulfur compounds) and terminal electron acceptor (nitrate) do not coexist.
ARCHAEA	
Methanogens <i>Methanococcus, Methanospirillum</i>	Generate methane when they oxidize hydrogen gas as an energy source, using CO ₂ as a terminal electron acceptor.
Extreme halophiles <i>Halobacterium, Halorubrum, Natronobacterium, Natronococcus</i>	Found in salt lakes, soda lakes, and brines. They produce pigments and can be seen as pink blooms in concentrated salt water ponds.

Contd...

...Contd.

Group/Genera	Characteristics
Methane-generating thermophiles <i>Methanothermus</i>	Found near hydrothermal vents; can grow at temperatures near 100°C.
Sulfur and sulfate-reducing hyperthermophiles <i>Thermococcus</i> , <i>Archaeoglobus</i> , <i>Thermoproteus</i> , <i>Pyrodictium</i> , <i>Pyrolobus</i>	Obligate anaerobes that use sulfur or, in one case, sulfate as a terminal electron acceptor, generating hydrogen sulfide. <i>Thermococcus</i> and <i>Archaeoglobus</i> (<i>Euryarchaeota</i>) oxidize organic compounds as an energy source; <i>Thermoproteus</i> , <i>Pyrodictium</i> , and <i>Pyrolobus</i> (<i>Crenarchaeota</i>) oxidize H ₂ as an energy source. Oxidize sulfur as a source of energy, using O ₂ as a terminal electron acceptor to generate sulfuric acid. They grow only at a temperature above 50°C and at a pH between 1 and 6. Grow only in extremely hot, acidic environments.
Sulfur oxidizers <i>Sulfolobus</i>	
Thermophilic extreme acidophiles <i>Thermophilus</i> , <i>Picrophilus</i>	

APPENDIX 2

Medically Important Chemoorganotrophs

Organism	Medical Significance
Gram-Negative Rods	
<i>Bacteroides</i>	Obligate anaerobes that commonly inhabit the mouth, intestinal tract, and genital tract. Causes abscesses and bloodstream infections.
<i>Enterobacteriaceae</i>	
<i>Enterobacter species</i>	Normal flora of the intestinal tract.
<i>Escherichia coli</i>	Normal flora of the intestinal tract. Some strains cause urinary tract infections; some strains cause specific types of intestinal disease. Causes meningitis in new borns.
<i>Klebsiella pneumoniae</i>	Normal flora of the intestinal tract. Causes pneumonia.
<i>Proteus species</i>	Normal flora of the intestinal tract. Causes urinary tract infections.
<i>Salmonella enteritidis</i>	Causes gastroenteritis. Grows in the intestinal tract of infected animals, acquired by consuming contaminated food.
<i>Salmonella typhi</i>	Causes typhoid fever. Grows in the intestinal tract of infected humans; transmitted in feces.
<i>Shigella species</i>	Causes dysentery. Grows in the intestinal tract of infected humans; transmitted in feces.
<i>Yersinia pestis</i>	Causes bubonic plague, which is transmitted by fleas, and pneumonic plague, which is transmitted in respiratory droplets of infected individuals.

Contd...

..Contd.

Organism	Medical Significance
<i>Haemophilus influenzae</i>	Causes ear infections, respiratory infections, and meningitis in children.
<i>Haemophilus ducreyi</i>	Causes chancroid, a sexually transmitted disease.
<i>Legionella pneumophila</i>	Causes legionnaires' disease, a lung infection. Grows within protozoa, acquired by inhaling contaminated water droplets.
<i>Pseudomonas aeruginosa</i>	Causes burns, urinary tract, and bloodstream infections. Ubiquitous in the environment. Grows in nutrient-poor aqueous solution and is resistant to many disinfectants and antimicrobial medications.
Gram-Negative Rods- Obligate Intracellular Parasites	
<i>Chlamydia pneumoniae</i>	Causes atypical pneumonia, or "walking pneumonia". Acquired from an infected person.
<i>Chlamydia psittaci</i>	Causes psittacosis, a form of pneumonia. Transmitted by birds.
<i>Chlamydia trachomatis</i>	Causes a sexually transmitted disease that mimics the symptoms of gonorrhea. Also causes trachoma, a serious eye infection, and conjunctivitis in newborns.
<i>Coxiella burnetii</i>	Causes Q fever. Acquired by inhaling organisms shed by infected animals.
<i>Ehrlichia chaffeensis</i>	Causes human ehrlichiosis. Transmitted by ticks
<i>Orientia tsutsugamushi</i>	Causes scrub typhus. Transmitted by mites.
<i>Rickettsia prowazekii</i>	Causes epidemic typhus. Transmitted by lice.
<i>Rickettsia rickettsii</i>	Causes rocky mountain spotted fever. Transmitted by ticks.
Gram-Negative Curved Rods	
<i>Campylobacter jejuni</i>	Causes gastroenteritis. Grows in the intestinal tract of infected animals, acquired by consuming contaminated food.
<i>Helicobacter pylori</i>	Causes stomach and duodenal ulcers. Neutralizes stomach acid by producing urease, resulting in the breakdown of urea to form ammonia.
<i>Vibrio cholerae</i>	Causes cholera, a severe diarrheal disease. Grows in the intestinal tract of infected humans; acquired by drinking contaminated water.
<i>Vibrio parahaemolyticus</i>	Cause gastroenteritis. Acquired by consuming contaminated seafood.

Contd...

...Contd.

Organism	Medical Significance
Gram-Negative Cocci	
<i>Neisseria meningitidis</i>	Causes meningitis.
<i>Neisseria gonorrhoeae</i>	Causes gonorrhea, a sexually transmitted disease.
Gram-Positive Rods	
<i>Bacillus anthracis</i>	Causes anthrax. Acquired by inhaling endospores in soil, animal hides, and wool. Bioterrorism agent.
<i>Bifidobacterium species</i>	Predominant member of the intestinal tract in breast-fed infants. Thought to play a protective role in the intestinal tract of infants by excluding pathogens.
<i>Clostridium botulinum</i>	Causes botulism. Disease results from ingesting toxin-contaminated food, typically canned foods that have been improperly processed.
<i>Clostridium perfringens</i>	Causes gas gangrene. Acquired when soil-borne endospores contaminate a wound.
<i>Clostridium tetani</i>	Causes tetanus. Acquired when soil-borne endospores are inoculated into deep tissue.
<i>Corynebacterium diphtheriae</i>	Toxin-producing strains cause diphtheria, a frequently fatal throat infection.
Gram-Positive Cocci	
<i>Enterococcus species</i>	Normal intestinal flora. Causes urinary tract infections.
<i>Micrococcus species</i>	Found on skin as well as in a variety of other environments; often contaminates bacteriological media.
<i>Staphylococcus aureus</i>	Leading cause of wound infections. Causes food poisoning and toxic shock syndrome.
<i>Staphylococcus epidermidis</i>	Normal flora of the skin.
<i>Staphylococcus saprophyticus</i>	Causes urinary tract infections
<i>Streptococcus pneumoniae</i>	Causes pneumonia and meningitis.
<i>Streptococcus pyogenes</i>	Causes pharyngitis (strep throat), rheumatic fever, wound infections, glomerulonephritis, and streptococcal toxic shock.
Acid-fast Rods	
<i>Mycobacterium tuberculosis</i>	Causes tuberculosis, typically a chronic respiratory infection.
<i>Mycobacterium leprae</i>	Causes Hansen's disease (leprosy); peripheral nerve invasion is characteristic.
Spirochetes	
<i>Treponema pallidum</i>	Causes syphilis, a sexually transmitted disease that can spread throughout the body. The organism has never been grown in culture.

Contd...

...Contd.

Organism	Medical Significance
<i>Borrelia burgdorferi</i>	Causes lyme disease, a tick-borne disease that initially causes a rash and then spreads throughout the body.
<i>Borrelia recurrentis</i> and <i>B. hermsii</i>	Causes relapsing fever. Transmitted by arthropods.
<i>Leptospira interrogans</i>	Causes leptospirosis, a waterborne disease that can spread throughout the body. Excreted in urine of infected animals.
Cell Wall-less <i>Mycoplasma pneumoniae</i>	Causes atypical pneumonia or walking pneumonia. Not susceptible to penicillin because it lacks a cell wall.

APPENDIX 3

Terms Used to Describe Microorganisms According to Their Metabolic Capabilities

Terms	Definition	Comments
Chemotroph	An organism that obtain energy by oxidizing chemicals, the same process provides reducing power for biosynthesis.	Aerobic respiration uses O ₂ as a terminal electron acceptor, anaerobic respiration uses an inorganic compound other than O ₂ as a terminal electron acceptor, and fermentation uses an organic compound such as pyruvate as a terminal electron acceptor.
Chemolithotroph	Inorganic chemicals such as H ₂ S are used as an energy source (<i>litho</i> -means "rock")	Generally, a chemolithotroph obtains carbon from CO ₂ and is therefore a chemoautotroph, because of this, the terms chemolithotroph and chemoautotroph are often used interchangeably. Alternatively, and more correctly, the term chemolithoautotroph is used.
Chemoorganotroph	Organic compounds such as glucose are used as an energy source.	A chemoorganotroph obtains carbon from organic compounds and is therefore a chemoheterotroph; because of this, the terms chemoorganotroph and chemoheterotroph are often used interchangeably. The term chemoorganoheterotroph is rarely used, although it is technically more correct.

Contd...

...Contd.

Terms	Definition	Comments
Phototrophs	Organisms that harvest energy from sunlight, cells need a source of electrons to make reducing power for biosynthesis.	Anoxygenic phototrophs use reduced compounds such as H_2S as a source of electrons for reducing power. Oxygenic phototrophs use H_2O as a source of electrons for reducing power, generating O_2 .
Photoautotroph	Energy is harvested from sunlight, carbon is obtained from CO_2	
Photoheterotroph	Energy is harvested from sunlight, carbon is obtained from organic compounds.	

□□□

QUESTIONS

SHORT & ESSAY TYPE QUESTIONS

- Q.1 What are microorganisms?
- Q.2 Define microbiology?
- Q.3 What is microbiology? Discuss about various facets of science of microbiology?
- Q.4 How will you prove that microorganisms can cause disease?
- Q.5 Describe the abiogenesis and biogenesis?
- Q.6 What are animalcules? Give a brief description about the discovery era of microbiology?
- Q.7 What is the 'golden age of microbiology'? Briefly describe the contribution of various scientist of the golden age of microbiology?
- Q.8 Give the contribution of the following:
(a) Anton Van Leuwenhoek (b) Louis Pasteur (c) Robert Koch (d) Joseph Lister (e) Alaxender Fleming (f) Edward Jenner
- Q.9 Write the name and scientific contribution of four noble laureates of last two decades?
- Q.10 What event, discovery or invention you consider the turning point that marks the birth of microbiology?
- Q.11 Write in detail about the three Kingdom classification of microorganism?
- Q.12 Discuss the whittaker's classification in detail?
- Q.13 What is three domain system, explain?

- Q.14 What are modern molecular biological parameters used in the classification of microorganism?
- Q.15 Explain the following:
(a) Morphological characters (b) Numerical taxonomy (c) RNA finger printing
(d) Molecular chronometers (e) 16 rRNA sequencing
- Q.16 Define evolution?
- Q.17 Gave the various theories in detail regarding the origin of earth?
- Q.18 Briefly describe the followings:
(a) Primitive atmosphere on earth (b) Nebular hypothesis (c) Planetesimal hypothesis
(d) Coacervates (e) Microsphere
- Q.19 Explain in detail the 'chemical origin of life'?
- Q.20 Define biological diversity. Discuss about microbial diversity in the context of future prospects.
- Q.21 Describe the significance of microbial diversity. What are its major applications in the field of microbiology?
- Q.22 Write in detail about the classification of bacteria adopted by Bergey's?
- Q.23 What are the basis of classification of Bacteria according to Bergey's manual?
- Q.24 Compare phenetic and phylogenetic approaches to microbial classification?
- Q.25 Why is DNA homology a better measure of relatedness than phenotypic characters for developing classification system?
- Q.26 Why does DNA homology better describe genetic relatedness than the proportion of G+C in the DNA?
- Q.27 How do computers help in the identification of bacteria?
- Q.28 How are the archaebacteria different from other bacterial groups? How has rRNA analysis helped to define relationship among these organisms?
- Q.29 Briefly state the characteristics of the following:
(a) Archaeobacteria (b) Cyanobacteria
- Q.30 Describe the different shapes of bacteria. What is the basis of arrangement of cells of bacteria?
- Q.31 Discuss the structure of flagella and pili in bacteria.
- Q.32 Describe the general structure of a bacterial cell.
- Q.33 Compare the cell wall of gram negative bacteria with that of gram positive bacteria.
- Q.34 What is peptidoglycan? Describe its structure.
- Q.35 Define the following terms:
(a) Capsule (b) Protoplast (c) Mesosome
- Q.36 Discuss in brief about the locomotion in bacteria.

- Q.37 Describe the structure of a prokaryotic cell. How does it differ from an eukaryotic cell?
- Q.38 Write the brief history of development of virology.
- Q.39 What is virus? Write in brief its general features and occurrence.
- Q.40 Give an illustrated account of morphology and chemical structure of different types of viruses?
- Q.41 Describe the structure of TMV and symptoms developed on tobacco plant.
- Q.42 Write an essay on multiplication of animal viruses.
- Q.43 What do you know about papova viruses with special reference to SV-40.
- Q.44 Write in detail about HIV, working of immune system and AIDS in humans.
- Q.45 Write short notes on the following:
- (a) Icosahedral symmetry
 - (b) Influenza virus
 - (c) Reo virus
 - (d) Herpes virus
 - (e) Rabies virus
 - (f) Retro virus
- Q.46 What do you know about bacteriophages? Discuss in detail the morphology of bacteriophages.
- Q.47 Give a detailed account of T₄ phage.
- Q.48 Describe the morphology, DNA and gene organisation in phage lambda.
- Q.49 Give an illustrated account of phage lambda.
- Q.50 Write short notes on the following:
- (i) T₄ phage (ii) M₄ (iii) M₁₃ (iv) Phage Lambda
- Q.51 Describe the general characteristics of viruses and the structure of tobacco mosaic virus.
- Q.52 Describe the general characteristics of cyanophages & bacteriophages.
- Q.53 Discuss the replication in bacterial viruses.
- Q.54 Discuss the mode of infection and invasion by HIV. What is the role of reverse transcriptase?
- Q.55 Express what is viral expression.
- Q.56 What characteristics of viruses could be used to characterize them as life forms? What makes them more similar to lifeless molecules?
- Q.57 How are viruses classified? What are virus families?
- Q.58 What are bacteriophages and what is their structure?
- Q.59 Compare and contrast the main phases in the lytic multiplication cycle in bacteriophages and animal viruses?

- Q.60 Discuss two ways that an RNA virus can replicate its genome?
- Q.61 How does a prion differ from a virus? How does a prion reproduce in a host cell?
- Q.62 What are similarities and differences between animal, plant and bacterial viruses.
- Q.63 How are the viruses transmitted?
- Q.64 Describe the epidemiological cycle in Rabies. Describe the infection cycle in humans?
- Q.65 What are reteroviruses and how are they different from other viruses? Give one example of principal reterovirus and the disease they cause?
- Q.66 List the secondary diseases that accompany AIDS? Why are AIDS patient so susceptible to kaposi's sarcoma?
- Q.67 Describe the epidemiology and progress of polio infection and disease? What causes the paralysis and deformity? Compare and contrast the two types of vaccines?
- Q.68 Describe the epidemilgoy of hepatitis A?
- Q.69 What are mycoplasmas? Describe the structure of a mycoplasmal cell.
- Q.70 Describe the pathogenic species of mycoplasma?
- Q.71 Write notes on the following diseases caused by mycoplasma:
 (a) Pleuroneumonia of cattle
 (b) Chronic respiratory disease
- Q.72 Write the names of plant diseases caused by mycoplasma.
- Q.73 Describe the structure of a cell of Rickettsia.
- Q.74 Where are Rickettsia found? How are they transmitted?
- Q.75 Name one disease caused by Rickettsia, also give symptoms of disease and its treatment.
- Q.76 What are Chlamydia? Where do they occur?
- Q.77 Write short notes on:
 (i) Trachoma (ii) Lymphogranuloma
- Q.78 Write short notes on:
 (i) Sheathed Bacteria (ii) Budding Bacteria
- Q.79 Write comparative description about green and purple bacteria.
- Q.80 Define the following terms:
 (a) Prosthecate bacteria
 (b) Endospore
 (c) Gliding bacteria
- Q.81 In what ways do spirochaetes differ from other bacteria? What combination of characteristics sets them apart?

- Q.82 Which genera of gram negative bacteria are associated with plants as nitrogen fixers?
- Q.83 List four genera of gram negative bacteria that produce distinctive pigments.
- Q.84 List four gram negative bacteria that are opportunistic pathogens.
- Q.85 What are the major difference between rickettsias and chlamydias?
- Q.86 How are rickettsias and chlamydias cultured in the laboratory?
- Q.87 How are rickettsias generally transmitted to humans? How does this differ from the way in which Q fever is transmitted?
- Q.88 List two anaerobic genera whose members obtain energy by respiration rather than by fermentation.
- Q.89 How and where might Rickettsia maintain itself between typhus epidemics.
- Q.90 In what fundamental way does rheumatic fever differ from most other kinds of disease caused by pathogenic bacteria.
- Q.91 How is *Micrococcus* distinguished from *Staphylococcus*?
- Q.92 List the major differences between the families of anoxygenic phototrophic bacteria.
- Q.93 In what ways do cyanobacteria differ from other phototrophic bacteria.
- Q.94 Besides the organism listed under gliding, non fruiting bacteria, what other kinds of bacteria may exhibit gliding motility?
- Q.95 Give an example of a genus of budding bacteria in which (a) the bud forms on a prostheca (b) the bud forms directly on the mother cell.
- Q.96 List the features of archaeobacteria that distinguish them from eubacteria.
- Q.97 How do the members of the order mycobacteroles differ from other gliding bacteria?
- Q.98 Yeasts, like molds, are fungi. How are they morphologically different from molds?
- Q.99 What are the major differences between photosynthesis by bacteria and algae?
- Q.100 Write in brief about the characters of different groups of photosynthetic bacteria.
- Q.101 Name a bacterium that is aerobic gram + ve and spore forming.
- Q.102 Name a bacterium that is pleomorphic and has palisade arrangement and metachromatic granules.
- Q.103 Name an acid fast bacterium.
- Q.104 Name two types of obligate intracellular parasitic bacteria.
- Q.105 Name a bacterium that lives in extremes of heat and salt.
- Q.106 Name a coccus that is gram positive and in chains.
- Q.107 Name a gram negative diplococcus.
- Q.108 Name a bacterium that contains sulphur granules.
- Q.109 Name a photosynthetic bacteria.
- Q.110 Name a chemosynthetic bacteria.

- Q.111 Name a gliding bacteria.
- Q.112 Name a sheathed bacteria.
- Q.113 Name a gram positive rod bacterium.
- Q.114 Name an aerobic phototrophic bacteria.
- Q.115 Name a budding bacteria.
- Q.116 What are actinomycetes? Compare actinomycetes with true molds.
- Q.117 Describe the main characteristics of Actinomycetes.
- Q.118 What is actinomycosis?
- Q.119 Write short notes:
 (a) Hansen's disease (b) Tuberculosis
- Q.120 Name two pathogenic species of *Mycobacteria*. What are the diseases caused by them?
- Q.121 Discuss the characteristics of algae that are used as a basis for algae classification.
- Q.122 How are algae similar to and different from higher green plants?
- Q.123 Describe the microbial association that exists in a lichen.
- Q.124 Describe the range of vegetative structure in algae with suitable examples.
- Q.125 With the help of suitable diagrams, describe the cell structure of an eukaryotic alga.
- Q.126 In what ways do the Ascomycetes find their place in industries?
- Q.127 Describe the different ways by which fungi reproduce asexually.
- Q.128 Describe sexual reproduction as it occurs in fungi.
- Q.129 Explain the difference between sexual spores and asexual spores, with particular reference to their formation.
- Q.130 What is unique about the class Deuteromycetes, making it different from other classes of fungi.
- Q.131 What is the derivation of the name protozoa? How are protozoa distinguished from other eukaryotic protists?
- Q.132 Give two specific examples of how protozoa adopt or respond to changing environmental conditions.
- Q.133 Briefly describe the different organelles found in the cytoplasm of a protozoa such as *Amoeba proteus*?
- Q.134 Describe the food gathering structures found in the ciliated protozoa.
- Q.135 What is a pellicle? Is it the same as the plasmalemma, Explain it.
- Q.136 Write short notes on:
 (i) Nature of mycoplasma
 (ii) L- form in mycoplasma

- (iii) Reproduction in mycoplasma
- (iv) Genetic material of mycoplasma
- (v) Locomotion in mycoplasma

- Q.137 Describe the structure and reproduction of mycoplasma.
- Q.138 Describe the symptoms and plant diseases caused by mycoplasma.
- Q.139 Explain the classification of Mycoplasma?
- Q.140 Describe the mode of transmission of mycoplasma in plants?
- Q.141 List the distinguishing features of Cyanophyceae.
- Q.142 Give an account of the distribution of the blue-green algae.
- Q.143 Describe the range of vegetative structure in the Cyanophyceae.
- Q.144 Give an account of the cell structure of a typical Cyanophycean cell.
- Q.145 What do you know about the mode of nutrition and cell differentiation in cyanophyceae?
- Q.146 Describe the different modes of reproduction met with in the Cyanophyceae.
- Q.147 Give an account of cell structure and methods of reproduction in Cyanophyceae.
- Q.148 Write notes on :
- (a) Hormogone of Oscillatoria; (b) Heterocysts, (c) Structural organisation of algal cell in Cyanophyceae; (d) Habit and Habitat of Nostoc, (e) Economic importance of blue-green algae, (f) Reproduction in Nostoc, (g) Nuclear structure of Nostoc.
- Q.149 Distinguish between heterocysts, akinetes and hormospores.
- Q.150 What are heterocysts? What is their function?
- Q.151 List the features which indicate that the blue-green algae are the primitive and ancient members of the plant kingdom. In what respects do they resemble the bacteria?
- Q.152 Name two symbiotic blue green algae.
- Q.153 Explain chromatic adaptation.
- Q.154 What are water blooms.
- Q.155 Name the pigments found in blue green algae.
- Q.156 Name the reserve food found in cyanobacteria.
- Q.157 Explain the importance of blue green algae in rice fields?
- Q.158 Explain sexual recombination in cyanobacteria.
- Q.159 Name two free living algae involved in nitrogen fixation.
- Q.160 Write an essay on the habitat of cyanobacteria.
- Q.161 Explain the mode of reproduction in blue green algae.
- Q.162 Write a note on the economic importance of algae.
- Q.163 Explain the ultrastructure of cyanophycean cell.

- Q.164 Explain heterocyst and its function.
- Q.165 Write an essay on the general characteristics of cyanobacteria.
- Q.166 Discuss laboratory diagnosis of syphilis.
- Q.167 Discuss pathogenesis of syphilis.
- Q.168 Write short notes on:
 (i) Classification of spirochetes
- Q.169 Write short notes on:
 (a) General characters of rickettsiae
 (b) Antigenic structure of rickettsiae
 (c) spotted fevers
- Q.170 Discuss laboratory diagnosis of rickettsial infections.
- Q.171 Discuss pathogenesis and laboratory diagnosis of polioviruses.
- Q.172 Discuss prophylaxis against poliomyelitis
- Q.173 Discuss the modes of transmission of HIV.
- Q.174. Describe the laboratory diagnosis of HIV infections.
- Q.175 Describe the antigenic structure of HIV and draw labelled diagram of HIV-1 and HIV-2
- Q.176 Discuss the pathogenesis and clinical features of HIV infection.
- Q.177 Discuss briefly the various opportunistic infections which can occur during the course of HIV infection.
- Q.178 Write short notes on:
 (a) Vaccines against HIV
 (b) Control of HIV
 (c) HIV-1 and HIV-2
- Q.179 Write short notes on:
 (a) Vaccinia virus
- Q.180 Name various viruses of the family Herpesviridae and discuss the various infections caused by herpes simplex virus type 1 and 2.
- Q.181 Write short notes on:
 (a) Human herpesvirus 6
 (b) Malignancies associated with Epstein-Barr virus
 (c) Varicella-zoster virus
- Q.182 Discuss pathogenesis and clinical syndromes caused by adenoviruses.
- Q.183 Discuss laboratory diagnosis of infections caused by adenoviruses.
- Q.184 Describe the pathogenicity and laboratory diagnosis of infections caused by papillomaviruses

OBJECTIVE TYPE (MULTIPLE CHOICE) QUESTIONS

1. The theory of abiogenesis was supported by:
(a) Thales (b) Newton
(c) Descartes (d) All the above
2. The earliest atmosphere contained:
(a) Much nitrogen (b) CH_4 , H_2 , NH_3 and H_2O
(c) No oxygen (d) All of the above
3. Which of the following was the source of energy during the early period of chemical evolution?
(a) Ultraviolet light, electric discharges.
(b) Ultraviolet light, electric discharges, heat from volcanoes.
(c) Torrential rains.
(d) By photosynthesis.
4. The biomolecules dissolved in the oceans producing a rich broth is called:
(a) Polymers (b) Polythene
(c) Primordial soup (d) All of the above
5. During the chemical evolution the biomolecules condense to form polymers like :
(a) Polypeptides (b) Polynucleotides
(c) Polysaccharides, Lipids (d) All of the above.
6. The earth is presumed to have originated 5-6 billion years ago:
(a) As a part broken from the molten mass of sun
(b) By gradual condensation of interstellar dust.
(c) Both a and b
(d) None of the above
7. The atmosphere of primitive earth was composed of:
(a) NH_3 , cyanides, carbon monoxide
(b) Steam, carbon dioxide
(c) Free hydrogen
(d) All of the above
8. The surface of the earth cooled:
(a) Because of solidification of carbon dioxide
(b) Because the cycle of raining continued for years.
(c) Because of conversion of steam into gases.
(d) All of the above

9. Scientist who performed experiments with few meat pieces kept in three jars, one left uncovered, other covered with muslin cloth and third one covered with parchment paper is:
- (a) Van Helmont (b) Francesco Reddi
(c) Abbe Spallanzani (d) R. Miller
10. During organic evolution the process of condensation and polymerization of the aldehydes and ketones and further their oxidation resulted in the formation of:
- (a) Proteins (b) Lipids
(c) Fatty acid (d) Glycerol
11. Heterotrichous habit means that the:
- (a) Whole plant body is prostrate
(b) Whole plant body is erect and aerial.
(c) A portion of plant body is erect and another portion is prostrate.
(d) None of the above
12. Which of the following algae is endozoic:
- (a) *Volvox* (b) *Polysiphonia*
(c) *Ulva* (d) *Zoochlorella*
13. Which of the following alga has been studied in space:
- (a) *Spirogyra* (b) *Chlorella*
(c) *Ulva* (d) *Chara*
14. Which of the following algae is terrestrial in habitat?
- (a) *Hydrodictyon* (b) *Chara*
(c) *Protococcus* (d) *Ulothrix*
15. Psychophilic bacteria are:
- (a) Heat loving (b) Cold loving
(c) Intermediate in temperature requirement
(d) None of the above
16. Pasteurization is a method of destroying bacteria by:
- (a) Long time-low temp. method
(b) Short time - low temp. method
(c) Short time - high temp. method
(d) Long time- high temp. method
17. Most of the insect transmission of viruses is done by the insects of order:
- (a) Orthoptera (b) Coleoptera
(c) Hemiptera (d) None of the above.

18. The time interval between infection of the host and appearance of first symptom is called:
- (a) Transition period (b) Latent period
(c) Incubation period (d) Infection period
19. The oldest fossil of bacterial like cells have been named as:
- (a) *Eubacterium isolatum* (b) Anabaena
(c) *Chlamydomonas* (d) Protenoids
20. The amino acids that are linked together on cooling to form long chains which resemble to the polypeptide chains of proteins were called as....by S.W. Fox:
- (a) Proteinoids (b) Broth
(c) Speroid (d) Microsphere
21. Microsphere exhibits some of the properties of the cells such as:
- (a) Can divide by fission
(b) Their surface is composed of two layers as in cells.
(c) In presence of Zn, these can split ATP.
(d) All of the above
22. The synthesis of carbohydrates, fats and complex organic substances which occurred in sea were called as:
- (a) The hot dilute soup (b) The hot dry soup
(c) The hot sweet soup (d) The hot soup
23. The term "The hot dilute soup" was described by:
- (a) Haldane (b) Miller
(c) Fox (d) Darwin
24. The first life was evolved on:
- (a) Land (b) Water
(c) Mountains (d) All of the above
25. Protovirus can be described as:
- (a) A free living virus (b) A free living gene
(c) A free living RNA (d) A free living DNA
26. When complete thallus in fungi undergoes sexual reproduction it is called:
- (a) Eucarpic (b) Holocarpic
(c) Homothallic (d) Heterothallic
27. Who gave generic classification for the first time:
- (a) Linnaeus (b) Bentham & Hooker
(c) Thakhtajan (d) Engler & Prantl

28. Vein clearing is a symptom caused by viruses. In this type of symptom, the tissue close to the vein turns.
- (a) Yellow (b) Green
(c) Red (d) Violet
29. In certain viral diseases the symptoms are not visible even if the plant is affected, these type of diseases are caused by:
- (a) Bacterial viruses (b) Viruses
(c) Latent virus (d) Mycophages
30. Most of the antibiotics have no effect on viruses because:
- (a) Viruses produce a thick covering & encyst themselves as endospores.
(b) Viruses have no metabolism of their own.
(c) Viruses are too small in size for antibiotics to act on them.
(d) None of the above
31. Which of the following is an example of DNA containing plant virus.
- (a) Tobacco mosaic virus (b) Cauliflower mosaic virus
(c) Potato virus X (d) Tomato mosaic virus
32. Archaeobacterial cell membranes contain branched chain lipids which enables them to:
- (a) Reproduce sexually (b) Tolerate extreme of heat and pH
(c) Both a & b (d) None
33. Soil dwelling decomposers are generally:
- (a) Filamentous bacteria (b) Actinomycetes
(c) Both a & b (d) None of the above
34. The scientist who first gave the evidence of a virus was:
- (a) Iwanowsky (b) Pasteur
(c) Mayer (d) Miller
35. Who was the scientist to crystallize the virus causing tobacco mosaic virus?
- (a) Hershey (b) Watson
(c) Stanley (d) Pasteur
36. The intact virus unit or infectious particle is called:
- (a) Virion (b) Capsomers
(c) Bacteriophage (d) Muton
37. Viruses consist of:
- (a) Simple structure
(b) Nucleic acid core surrounded by a protein coat

- (c) No nucleic acid
(d) Both a & b
38. Some viruses multiply as soon as they enter the host cell, resulting in lysis or breakdown of the host cell. Such viruses are called:
- (a) Lytic viruses (b) Prophage
(c) Lysogenic viruses (d) None of the above
39. When the viral chromosome becomes integrated with the host chromosome it is called as a :
- (a) Lytic virus (b) Prophage
(c) Both a & b (d) None of the above
40. When the flagella arises from all over the cell in bacteria, it is known as:
- (a) Peritrichous (b) Fimbriae
(c) Pili (d) None of the above
41. Cell wall is more complex in:
- (a) Gram-negative bacteria (b) Gram-positive bacteria
(c) Both a & b (d) None of the above
42. The bacterial cells are surrounded by a capsule made up of:
- (a) Polysaccharides (b) Disaccharides
(c) Polypeptides (d) All of the above
43. Which of the following is a photosynthetic bacteria?
- (a) Green bacteria (b) Purple bacteria
(c) Both a & b (d) None of the above
44. In green sulphur bacteria the reaction centre pigments of photosynthesis are:
- (a) Bacteriochlorophyll c (b) Bacteriochlorophyll d
(c) Bacteriochlorophyll a (d) All of the above
45. In addition to the circular DNA chromosome, a small amount of subsidiary extrachromosomal DNA is also present in bacteria which is known as:
- (a) Episome (b) Plasmids
(c) Both a & b (d) None of the above
46. In purple sulphur bacteria.....is the electron donor:
- (a) Hydrogen sulphide (b) Sodium chloride
(c) Ammonium sulphite (d) None of the above
47. Some Archaeobacteria live in extreme strong brine solutions they are known as:
- (a) Halophiles (b) Hydrophiles
(c) Cryophiles (d) Bryophiles

48. **Thallophytes containing the green colour in matter chlorophyll is:**
 (a) Algae (b) Fungi
 (c) Slimemoulds (d) Lichen
49. **In many algae, the colour is other than green, these:**
 (a) Do not contain chlorophyll (b) Do contain chlorophyll
 (c) Both (a) and (b) (d) None
50. **Thallophytes having no chlorophyll present are known as:**
 (a) Algae
 (b) Algae other than green algae
 (c) Fungi
 (d) None of the above
51. **Algae are:**
 (a) Autotropic (b) Heterotropic
 (c) Parasite (d) Saprophyte
52. **The body of algae is composed of a :**
 (a) True parenchymatous tissue
 (b) False tissue or pseudo-parenchyma
53. **The body of fungi is composed of:**
 (a) True parenchymatous tissue
 (b) False tissue or pseudo-parenchyma
54. **The cell wall of an algae is composed of:**
 (a) True cellulose
 (b) Chitin mixed with cellulose in different proportions
55. **Algae live in/on:**
 (a) Water (b) Another plant
 (c) Decaying animal or vegetable matter
 (d) None of the above
56. **Fungi live in on:**
 (a) Water substratum (b) Another plant
 (c) Decaying animal or vegetable matter
 (d) Both b and c
57. **Reserve carbohydrate in fungi is:**
 (a) Starch (b) Glycogen
 (c) Oil (d) Protein

58. Reserve carbohydrate in algae is:
- (a) Starch
 - (b) Glycogen
 - (c) Oil
 - (d) Protein
59. Algae are:
- (a) Unicellular
 - (b) Multicellular
 - (c) Both
 - (d) None of the above
60. Fungi are:
- (a) Filamentous
 - (b) Thalloid
 - (c) Both
 - (d) None of the above
61. Reproduction in algae may take place by:
- (a) Vegetatively by cell division
 - (b) Detachment of a portion of the mother plant
 - (c) Asexually by spores
 - (d) Sexually by gametes
 - (e) All of these ways are possible
62. Blue green algae was known as:
- (a) Rhodophyceae
 - (b) Phaeophyceae
 - (c) Chlorophyceae
 - (d) Myxophyceae
63. Green algae is:
- (a) Rhodophyceae
 - (b) Myxophyceae
 - (c) Chlorophyceae
 - (d) Phaeophyceae
64. Red algae is:
- (a) Rhodophyceae
 - (b) Myxophyceae
 - (c) Chlorophyceae
 - (d) Phaeophyceae
65. Brown algae is:
- (a) Rhodophyceae
 - (b) Myxophyceae
 - (c) Chlorophyceae
 - (d) Phaeophyceae
66. Cyanophyceae or blue-green algae contain:
- (a) Chlorophyll
 - (b) Phycocyanins
 - (c) Xanthine
 - (d) All of the above
67. Cyanophyceae algae:
- (a) Has clearly differentiated protoplast
 - (b) Has no clearly differentiated protoplast
 - (c) Has no differentiated protoplast

68. In Cyanophyceae or blue-green algae:
- (a) All the species are unicellular
 - (b) Daughter cells after division adhere together to form a chain of cells (filament) or spherical colonies.
 - (c) Some species are unicellular while other have daughter cells adhering together to form filaments or spherical colonies.
69. Cyanophyceae has got:
- (a) Definite nucleus & plasmid
 - (b) No definite nucleus but plastid
 - (c) Neither definite nucleus nor plastid
 - (d) Definite nucleus but no plastid
70. In cyanophyceae, the protoplast is differentiated into peripheral zone & inner portion. Which of the zone is colourless?
- (a) Peripheral zone
 - (b) Inner zone
 - (c) None
 - (d) Both
71. Cell wall of cyanophyceae are made up of:
- (a) Starch
 - (b) Cellulose
 - (c) Protein & lipids
 - (d) Cellulose & pectic compounds
72. Carbohydrates in cyanophyceae occurs in the form of:
- (a) Starch
 - (b) Glycogen
 - (c) Glucose
 - (d) Fructose
73. Blue-green algae:
- (a) Reproduce sexually
 - (b) Never reproduce sexually
 - (c) Bear ciliated bodies
 - (d) Do not bear any kind of ciliated bodies
74. The common method of vegetative reproduction in blue-green algae is:
- (a) Cell division
 - (b) Breaking up of colony
 - (c) Fragmentation of filament
 - (d) All of these may be possible
75. In blue-green algae, during vegetative reproduction, hormogonia are produced by:
- (a) Cell-division
 - (b) Breaking up of colony
 - (c) Fragmentation of filament
76. During reproduction in blue-green algae heterocyst are seen in:
- (a) Unicellular forms
 - (b) Colonial forms
 - (c) Filamentous forms
 - (d) None of the above
77. Gleocapsa (blue-green algae) is:
- (a) Unicellular
 - (b) Spherical
 - (c) Colonial
 - (d) Filamentous

78. **Nostoc is common blue-green algae of:**
(a) Unicellular form (b) Spherical form
(c) Colonial form (d) Filamentous form
79. **Nostoc reproduces:**
(a) By fragmentation (b) Asexually by resting cells
(c) By both processes (d) None
80. **Euglenophyceae (algae) is:**
(a) Single celled (b) Multi celled
81. **Euglenophyceae is:**
(a) Naked, free swimming organism
(b) Hidden, free swimming organism
(c) Naked, linked organism
(d) Hidden, linked organism
82. **Euglenophyceae contains:**
(a) No plastids (b) A few green plastids
(c) Several green plastids
83. **Euglenophyceae is:**
(a) Heterotrophic (b) Autotrophic
(c) Autotrophic in light but heterotrophic in dark
84. **Green algae is:**
(a) Unicellular (b) Colonial being non-motile or motile
(c) Multicellular being thalloid (d) All of these
85. **Chloroplasts in green algae have the shape of:**
(a) Cup (b) Plate-like
(c) Spherical (d) All of these
86. **Asexual reproduction takes place in chlorophyceae by spores which are of type:**
(a) Zoospore (b) Aplanospore
(c) Akinete (d) All of these
87. **Sexual reproduction in chlorophyceae takes place by:**
(a) Isogamy (b) Anisogamy
(c) Oogamy (d) All of these
88. **In sexual reproduction:**
(a) Some species are homothallic while other are heterothallic
(b) All the species are homothallic
(c) All the species are heterothallic

89. In many green algae a gamete grows without fusion with another gamete into a new plant. The gamete thus behaves as a spore. It is better known as:
- (a) Zoospore (b) Aplanospore
(c) Akinete (d) Parthenospore
90. *Chlamydomonas* is a:
- (a) Blue-green algae (b) Green algae
(c) Purple algae (d) Red algae
91. *Chlamydomonas* is usually:
- (a) Unicellular (b) Multicellular
(c) Filamentous (d) Branched
92. One of the following algae is intermediate between two. Which of the following order is correct:
- (a) Flagellate algae-*Chlamydomonas*-higher algae.
(b) *Chlamydomonas*-flagellate algae-higher algae
(c) Flagellate algae-higher algae - *Chlamydomonas*
93. *Chlamydomonas* reproduce asexually by:
- (a) Zoospores (b) Aplanospore
(c) Parthenospore (d) All of these
94. In *Chlamydomonas*, palmella stage is the one where:
- (a) During asexual reproduction the daughter cells form zoospores.
(b) During asexual reproduction the daughter cells divide repeatedly into numerous cells lying embedded in gelatinous matrix.
(c) During sexual reproduction motile ciliated gametes are formed.
95. *Endorina* is a:
- (a) Colonial algae (b) Filamentous algae
(c) Unicellular (d) Spherical
96. Each colony known as coenobium in *Endorina* consists of:
- (a) 16 cells (b) 32 cells
(c) 100 cells (d) 1,000 cells
97. In *Volvox* a mature colony consists a few hundred to several thousands of cells. These cells constitute:
- (a) Small vegetative cells (b) Large cells
(c) Small vegetative cells and a few large cells among the former
98. A vegetative cell in *Volvox* has following constituents:
- (a) Two cilia protruding outwards
(b) 2-5 contractile vacuoles

- (c) A central nucleus
 - (d) Cup shaped or plate-like chloroplast
 - (e) One Pyrenoid
 - (f) Eye spot
 - (g) All of these
99. True slime molds are named as:
- (a) Myxomycota
 - (b) Eumycota
 - (c) Chrysophyceae
 - (d) Euglenophyceae
100. Plant body usually composed of hyphae:
- (a) Myxomycota
 - (b) Eumycota
101. True fungi in which sexual reproduction unknown:
- (a) Phycomycetes
 - (b) Ascomycetes
 - (c) Basidiomycetes
 - (d) Deuteromycetes
102. Gamete is a cell that grows into a new individual:
- (a) By its own division
 - (b) Only after fusion with another gamete
 - (c) By fragmentation
103. In sexual reproduction when the gametes are unequal in size, large, & non-motile, it is:
- (a) Isogamy
 - (b) Oogamy
 - (c) Sexual reproduction
 - (d) None of the above
104. During sexual reproduction algae produces:
- (a) Oospores
 - (b) Zygosporangia
 - (c) Meiosporangia
 - (d) Ascospores
105. Flagellates are heterozygous group of organisms identified in part by the presence of an elongated, whip like appendage by which:
- (a) Non-motility is brought about
 - (b) Motility is brought about
106. Flagellates-in their structure, in their pigments & in their storage products:
- (a) Differ
 - (b) Do not differ
107. Who proved that viruses can pass through bacterial proof filters:
- (a) Iwonowski D.
 - (b) Mayer A.E.
 - (c) Beijernick M.W.
 - (d) F.C. Bawden
108. Who gave the nucleoprotein nature of viruses:
- (a) Bawden F.C. & Pierie
 - (b) W.M. Stanley
 - (c) A.F. Meyer
 - (d) B.Kassarlis

109. Name any double stranded RNA viruses injecting plant:
 (a) Clover wound tumor virus (b) Maize rough dwarf virus
 (c) Rice dwarf (d) Citrus tristega
 (e) Maize mosaic (f) Rice tungro
110. Name one DNA virus infecting plant:
 (a) Cauliflower mosaic (b) Potato leaf roll
 (c) Potato virus X (d) Potato virus Y
111. Name a viroids which cause diseases in plants:
 (a) Citrus escocortis (b) Potato spindle tuber
 (c) Citrus tristeza (d) Potato acuba mosaic
112. Most important insect vector of plant viruses is:
 (a) Aphids (b) Leaf hoppers
 (c) Bugs (d) Thrips
113. List important viruses of potato:
 (a) Potato virus X (b) Potato virus Y
 (c) Potato virus S (d) Potato virus M
114. Who showed for the first time that mycoplasma also cause plant diseases:
 (a) Doi, Teranka, Yora, Asuyasna (b) W.M. Stanley
 (c) Dorittle S.P. (d) F.C. Bawden
115. Mycoplasma contain either:
 (a) RNA (b) DNA
 (c) Both (d) None
116. Mycoplasma can be cultured:
 (a) Yes (b) No
117. So far cultured mycoplasma which cause disease in plants:
 (a) *Sporoplasma citri* (b) *Acholeplasma* sp.
 (c) *Thermoplasma* sp. (d) None
118. Penicillin is active against gram + ve or gram - ve bacteria.
 (a) Gram + ve (b) Gram - ve
119. Name the man who observed bacteria for the first time:
 (a) Antony van Leuwenhoeak (b) T.J. Burrill
 (c) E.F. Smith (d) Robert Koch
120. Which of the following genus/genera belongs to family Spirochaetaceae?
 (a) *Spirochaeta* (b) *Treponema*
 (c) *Borrelia* (d) All of the above

121. Which of the following genera does not belong to family Spirochaetaceae?
(a) *Leptospira* (b) *Spirochaeta*
(c) *Treponema* (d) *Borrelia*
122. Three to four endoflagella are present at each pole in:
(a) *Treponema* (b) *Borrelia*
(c) *Leptospira* (d) None of the above
123. A single endoflagellum is present at each pole in:
(a) *Treponema* (b) *Borrelia*
(c) *Leptospira* (d) None of the above
124. Which of the following staining techniques cannot be used for *T. pallidum*?
(a) Gram staining (b) Giemsa staining
(c) Silver impregnation staining (d) Immunofluorescence staining
125. *Treponema pallidum* can be cultivated in:
(a) rabbit testes (b) Blood agar medium
(c) Chocolate agar medium (d) Thayer-martin medium
126. Which of the following techniques can be used for inactivation of *Treponema pallidum*?
(a) Heating at 41.5°C for 1 hour. (b) Storing at 5°C for 5 days.
(c) Lyophilization (d) All of the above
127. Group-specific antigen of *Treponema* is chemically at:
(a) protein (b) polysaccharide
(c) lipid (d) nucleic acid
128. Which of the following tests is performed most often for the serodiagnosis of syphilis?
(a) VDRL test (b) Kahn test
(c) Wasserman reaction (d) Reiter protein complement fixation test
129. Which of the following diseases is/are non venereal?
(a) Endemic syphilis (b) Yaws
(c) Pinta (d) All of the above
130. Louse-borne relapsing fever is caused by:
(a) *Borrelia recurrentis* (b) *B. duttoni*
(c) *B. burgdorferi* (d) *B. parkeri*
131. Relapses in relapsing fever occur due to:
(a) Antigen variation in bacteria. (b) increased toxin production by bacteria
(c) increased invasiveness of bacteria
(d) Super infection with viruses

132. Lyme disease is caused by:
- (a) *Borrelia recurrentis* (b) *B. duttoni*
 (c) *B. burgdorferi* (d) *B. hermsii*
133. Erythema chornium migrans is observed in:.,
- (a) Lyme disease (b) Relapsing fever
 (c) Weil's disease (d) Syphilis
134. Which of the following bacteria is/are pathogenic?
- (a) *Leptospira interrogans* (b) *L. biflexa*
 (c) *L. parva* (d) All of the above
135. A 22-year old homosexual man feeling feverish and anorexic for the past few days presents with generalized lymphadenopathy. A diffuse maculopapular rash is present over his hand, neck, palms and soles. Which of the following organisms is the most likely causes of the disease?
- (a) Human immunodeficiency virus
 (b) *Neisseria meningitidis*
 (c) *Treponema pallidum*
 (d) *Coxiella burnetii*
136. Which of the following bacteria does not require an arthropod vector for its transmission?
- (a) *Coxiella burnetii* (b) *Rickettsia akari*
 (c) *R. prowazekii* (d) *Bartonella quintana*
137. The causative agent of Q fever is:
- (a) *Rickettsia prowazekii* (b) *R. akari*
 (c) *Coxiella burnetii* (d) *Orientia tsutsugamushi*
138. The causative agent of epidemic typhus is:
- (a) *Rickettsia prowazekii* (b) *R. akari*
 (c) *Coxiella burnetii* (d) *R. rickettsii*
139. Human body louse is responsible for transmission of which of the following diseases?
- (a) Epidemic typhus (b) Murine typhus
 (c) Rickettsial pox (d) Q fever
140. Mites are responsible for transmission of which of the following diseases?
- (a) Epidemic typhus (b) Murine typhus
 (c) Scrub typhus (d) Trench fever
141. The causative agent of cat-scratch disease is:
- (a) *Bartonella henselae* (b) *B. quintana*
 (c) *Coxiella burnetii* (d) *Rickettsia prowazekii*

142. Which of the following rickettsiae can be grown on artificial media?
(a) *Bartonella quintana* (b) *Coxiella burnetii*
(c) *Rickettsia prowazekii* (d) All of the above
143. Which of the following diseases can be spread by ixodid ticks?
(a) Rocky mountain spotted fever (b) Epidemic typhus
(c) Trench fever (d) All of the above
144. Which of the following stains can demonstrate *Rickettsia*?
(a) Gram stain (b) Acid-fast stain
(c) Giemsa stain (d) All of the above
145. Which disease was a major factor in Napoleon's defeat in Russia in 1812?
(a) Epidemic typhus (b) Relapsing fever
(c) Dysentery (d) Plague
146. Which of the following characters is/are shown by chlamydiae?
(a) Lack of peptidoglycan
(b) Lack of ability to produce their own ATP
(c) Production of inclusion bodies.
(d) All of the above
147. Which of the serovars of *Chlamydia trachomatis* cause trachoma?
(a) A, B, Ba, C (b) D-K
(c) L1-L3 (d) All of the above
148. Which of the following bacteria cause tuberculosis in man?
(a) *Mycobacterium tuberculosis* (b) *M. bovis*
(c) *M. africanum* (d) All of the above
149. The causative agent of Buruli ulcer is:
(a) *Mycobacterium ulcerans* (b) *M. marinum*
(c) *M. chelonae* (d) *M. fortuitum*
150. Which of the following bacteria is/are microaerophilic on primary isolation:
(a) *Mycobacterium tuberculosis* (b) *M. bovis*
(c) Both of the above (d) None of the above
151. Which of the phage types of *Mycobacterium tuberculosis* occurs most frequently in India?
(a) Type A (b) Type B
(c) Type C (d) Type I
152. Humans become infected with *Mycobacterium tuberculosis* most frequently by:
(a) inhalation (b) ingestion
(c) contact (d) inoculation

153. BCG vaccine is a:
- (a) live attenuated preparation (b) killed preparation
 (c) toxoid preparation (d) recombinant preparation
154. Rough, buff and tough colonies on LJ medium are characteristics of:
- (a) *Mycobacterium tuberculosis* (b) *M. bovis*
 (c) both of the above (d) None of the above
155. *Mycobacterium tuberculosis* is pathogenic for:
- (a) rabbits (b) guinea-pigs
 (c) both of the above (d) none of the above
156. Members of the genus *Mycobacterium* are:
- (a) gram-positive (b) acid-fast
 (c) non-motile (d) All of the above
157. Which of the following bacteria is saprophytic?
- (a) *Mycobacterium chelonae* (b) *M. smegmatis*
 (c) *M. xenopi* (d) *M. marinum*
158. Which of the following bacteria is acid-fast?
- (a) *Actinomyces* (b) *Nocardia*
 (c) *Streptomyces* (d) *Corynebacterium*
159. Which of the following bacteria is the commonest cause of cervicofacial actinomycosis?
- (a) *Actinomyces israelii* (b) *A. naeslundii*
 (c) *A. viscosus* (d) *A. meyeri*
160. Which part of the body is most commonly involved in nocardiosis?
- (a) Lungs (b) Skin
 (c) Eye (d) Liver
161. Which of the following genera is/are included in the family Picornaviridae?
- (a) *Enterovirus* (b) *Rhinovirus*
 (c) *Hepatovirus* (d) All of the above
162. Which of the following serotypes is/are usually associated with endemic polio infections?
- (a) Type 1 (b) Type 2
 (c) Type 3 (d) All of the above
163. Which of the following polio vaccines induces production of IgA antibodies?
- (a) Salk (b) Sabin
 (c) Both of the above (d) None of the above

164. Which of the following viruses are acid-labile?
(a) Rhinoviruses (b) Echoviruses
(c) Polioviruses (d) Coxsackieviruses
165. How many serotypes of rhinoviruses are there?
(a) Ten (b) Twenty
(c) Sixty (d) More than one hundred
166. HIV belongs to the family retroviridae and sub-family:
(a) Oncovirinae (b) Lentivirinae
(c) Spumavirinae (d) None of the above
167. Which is the spike antigen of HIV-1?
(a) gp 120 (b) gp 140
(c) gp 41 (d) gp 36
168. Which is the transmembrane pedicle antigen of HIV-1?
(a) gp 120 (b) gp 140
(c) gp 41 (d) gp 36
169. Which is the commonest mode of transmission of HIV?
(a) Sexual (b) Parenteral
(c) Perinatal (d) Oral
170. What is the efficiency of transmission of HIV by blood transfusion?
(a) > 90% (b) 13-40%
(c) 2.5% (d) 0.5-1%
171. What is the cause of death in AIDS patients?
(a) Opportunistic infections (b) Malignancies
(c) Cachexia-like state (d) All of the above
172. Which cells are infected by HIV most often?
(a) CD4+ T lymphocytes (b) CD8 + T lymphocytes
(c) Null cells (d) B Cells
173. HIV can infect:
(a) CD4 + T lymphocytes (b) monocytes
(c) microglial cells (d) All of the above
174. What is the average incubation period for development of AIDS?
(a) One year (b) Five years
(c) Ten years (d) Fifteen years
175. Which is the commonest bacterial infection in HIV disease?
(a) *Mycobacterial* infection (b) *Salmonella* infection
(c) *Bartonella* infection (d) *Klebsiella* infection

176. **Viral infection/s frequently observed in HIV disease is/are:**
 (a) Herpes simplex (b) Varicella-zoster
 (c) Cytomegalovirus (d) All of the above
177. **Fungal infections frequently observed in HIV disease is/are:**
 (a) Candidiasis (b) Cryptococcosis
 (c) Aspergillosis (d) All of the above
178. **Parasitic infections frequently observed in HIV disease is/are:**
 (a) Isosporiasis (b) Toxoplasmosis
 (c) Cryptosporidiosis (d) All of the above
179. **Which is the commonest opportunistic infection in AIDS patients in India?**
 (a) Tuberculosis (b) Toxoplasmosis
 (c) Cryptosporidiosis (d) Cryptococcosis
180. **Which of the following tests is/are screening tests for diagnosis of HIV infection?**
 (a) ELISA (b) Latex agglutination
 (c) Dot blot assay (d) All of the above
181. **Which of the following tests is/are confirmatory tests/for HIV infection?**
 (a) Virus isolation (b) Detection of p24 antigen
 (c) Detection of viral nucleic acid (d) All of the above
182. **Which of the following antiviral agents has been most widely used to inhibit HIV replication?**
 (a) Azidothymidine (b) Zintevir
 (c) Nevirapine (d) Indinavir
183. **Azidothymidine is a:**
 (a) dideoxynucleoside analogue (b) non nucleoside inhibitor
 (c) protease inhibitor (d) integrase inhibitor
184. **What are the problems associated with development of a vaccine against HIV?**
 (a) Rapid mutation of HIV
 (b) Antibody alone may be insufficient
 (c) Virus can spread from cell to cell by fusion to produce syncytia
 (d) All of the above
185. **Which of the following genera can cause disease in humans?**
 (a) Orthopoxvirus (b) Parapoxvirus
 (c) Molluscipoxvirus (d) All of the above
186. **World's last naturally occurring case of small pox was recorded in:**
 (a) 1957 (b) 1967
 (c) 1977 (d) 1987

187. Which of the following viruses was used for vaccination against smallpox?
(a) Vaccinia (b) Small pox
(c) Cow pox (d) Buffalo pox
188. Which of the following diseases can be caused by genus Orthopoxvirus?
(a) Small pox (b) Vaccinia
(c) Cow pox (d) All of the above
189. What is the symmetry of nucleocapsid of poxviruses?
(a) Icosahedral (b) Helical
(c) Complex (d) None of the above
190. Which of the following infections is caused by herpes simplex virus type I?
(a) Acute gingivostomatitis (b) Keratoconjunctivitis
(c) Encephalitis (d) All of the above
191. Which of the following viruses has/have been blamed to cause cervical carcinoma?
(a) Cytomegalovirus (b) Epstein-Barr virus
(c) Herpes simplex virus type 2 (d) All of the above
192. Which of the following drugs can be used for the treatment of herpes simplex virus infections?
(a) Acyclovir (b) Azidothymidine
(c) Ribavirin (d) All of the above
193. Which of the following viruses belongs to sub-family gammaherpesvirinae?
(a) Varicella-zoster virus (b) Epstein-Barr virus
(c) Human cytomegalovirus (d) Herpes simplex virus type I
194. What is the symmetry of adenoviruses?
(a) Icosahedral (b) Helical
(c) Complex (d) None of the above
195. Which of the following cell lines can be used for the growth of adenoviruses?
(a) HeLa (b) HEP-2
(c) KB (d) All of the above
196. Which of the following serotypes of adenoviruses are associated with respiratory infections?
(a) Serotypes 1-7 (b) Serotypes 19 and 37
(c) Serotypes 40 and 41 (d) All of the above
197. How many serotypes of adenoviruses are known?
(a) 29 (b) 37
(c) 47 (d) 50

198. Which of the following viruses is also known as 'adeno-associated virus'?
- (a) Parvovirus (b) Erythrovirus
(c) Dependovirus (d) JC polyomavirus
199. Which of the following oncogenic viruses was first detected?
- (a) Herpes simplex virus type 2 (b) Epstein-Barr virus
(c) Rous sarcoma virus (d) Human T cell leukaemia virus
200. Which of the following viruses has not been associated with human cancer?
- (a) Varicella-zoster virus (b) Hepatitis B virus
(c) Hepatitis C virus (d) Herpes simplex virus type 2
201. What is the usual habitat of endospore-forming bacteria that are agents of disease?
- (a) Intestine of animals (b) Dust and soil
(c) Water (d) Foods
202. Most *Bacillus* species are:
- (a) True pathogens (b) Opportunistic pathogens
(c) Non Pathogens (d) Commensals
203. Many clostridial diseases require an environment for their development.
- (a) living tissue (b) aerobic
(c) anaerobic (d) low-pH
204. Soil mycobacteria can be the cause of:
- (a) Tuberculosis (b) Leprosy
(c) Listeriosis (d) Swimming pool granuloma
205. Which infectious agent is an obligate parasite?
- (a) *Mycobacterium tuberculosis* (b) *Cornyebacterium diphtheriae*
(c) *Mycobacterium leprae* (d) *Clostridium difficile*
206. Which infectious agents are facultative pathogens?
- (a) *Bacillus anthracis* (b) *Clostridium tetani*
(c) *Clostridium perfringens* (d) All of these
207. The treatment of choice of syphilis is:
- (a) Tetracycline (b) Penicillin
(c) Antiserum (d) Sulfa drugs
208. Lyme disease is caused by and spread by:
- (a) *Borrelia recurrentis*, lice (b) *Borrelia hermsii*, ticks
(c) *Borrelia burgdorferi*, chiggers (d) *Borrelia burgdorferi*, ticks
209. Relapsing fever is spread by:
- (a) lice (b) ticks
(c) animal urine (d) a and b

- 210. Rickettsias and chlamydias are similar in being:**
(a) Free of a cell wall (b) the cause of eye infections
(c) Carried by anthropod vectors (d) obligate intracellular bacteria
- 211. Which of the following is NOT an anthropod vector of rickettsioses?**
(a) mosquito (b) louse
(c) tick (d) flea
- 212. Chlamydiosis caused by *C. trachomatis* attacks which structure?**
(a) eye (b) urethra
(c) fallopian tubes (d) all of these
- 213. Ornithosis is a tubes infection associated with:**
(a) Rickettsia, parrots (b) Chlamydia, mice
(c) Chlamydia, birds (d) Rickettsia, flies
- 214. Mycoplasmas attack the.....of host cells.**
(a) nucleus (b) cell walls
(c) ribosomes (d) cell membranes
- 215. What is the shape of rabies virus?**
(a) Spherical (b) Polygonal
(c) Bullet-shaped (d) Tubular
- 216. Which of the following species of animals is most susceptible to rabies infection?**
(a) Skunk (b) Dog
(c) Cat (d) Fowl
- 217. Negri bodies can be demonstrated in infection with:**
(a) fixed rabies virus (b) street rabies virus
(c) both of the above (d) none of the above
- 218. Which of the following viral infections is associated with development of hydrophobia?**
(a) Influenza (b) Polio
(c) Rabies (d) Hepatitis
- 219. Which of the following rabies vaccines is a second-generation cell culture vaccine?**
(a) Duck egg vaccine (b) Semple vaccine
(c) Suckling mouse brain vaccine (d) Purified chick embryo cell vaccine
- 220. Euglena, a protozoan is a:**
(a) Heterotroph (b) Mixotroph
(c) Autotroph (d) None

221. During longitudinal binary fission the nuclear division is called:
 (a) Eumitosis (b) Paramitosis
 (c) Cryptomitosis (d) Amitosis
222. The cystic wall in *Euglena* is composed of:
 (a) Sclero-protein (b) Mucopolysaccharide
 (c) Chitin (d) cellulose
223. Which of the following is a good example of symbiosis between two animals:
 (a) Occurrence of certain protozoans in the gut of termites
 (b) Lichens made of algae and fungi
 (c) Occurrence of life history stages of malaria parasite inside the body of *Anopheles* mosquito
 (d) Domestication of cow by man
224. Why *Amoeba* is kept in protozoa:
 (a) Due to contractile vacuole (b) Because of nutrition being insectivorous
 (c) Cell wall (d) Acellular body
225. Protozoan considered link between plants and animals:
 (a) *Paramecium* (b) *Amoeba*
 (c) *Euglena* (d) *Plasmodium*
226. The encystment in protozoan take place in condition of:
 (a) Lack of food (b) Drought
 (c) Excessive heat (d) All of them
227. *Amoeba* belongs to class Sarcodina which is characterised by:
 (a) Acellular body (b) Pseudopodia for locomotion
 (c) Uninucleate body (d) Presence of contractile vacuole
228. Which is oldest one of the animals :
 (a) *Amoeba* (b) *Paramecium*
 (c) *Euglena* (d) *Opalina*
229. Bacteria was firstly discovered by :
 (a) Leuwenhoek (b) Jenner
 (c) Koch (d) Pasteur
230. The bacteria found in the roots of Leguminous plant is :
 (a) *Azotobacter* (b) *Rhizobium*
 (c) *Nitrosomonas* (d) *Aerobacter*
231. Mucopptide is found in :
 (a) Cyanobacteria (b) Green algae
 (c) Bacteria (d) Yeast

232. The disease caused by bacteria is :
- (a) Typhoid (b) Malaria
(c) Small pox (d) AIDS
233. The site of respiration in bacteria is:
- (a) Carboxysome (b) Mesosome
(c) Ribosome (d) Cell membrane
234. Bacteria caused plant disease is:
- (a) White rust of crucifers
(b) Yellow vein mosaic of bhindi
(c) Wilt of potato
(d) Stem rust of wheat
235. The Bacteria responsible for reducing the soil fertility is:
- (a) Denitrifying bacteria
(b) Fermentation bacteria
(c) Nitrifying bacteria
(d) none
236. A free living bacteria able to fix free atmospheric nitrogen is:
- (a) *Rhizobium* (b) *Azotobacter*
(c) *Bacillus* (d) *Streptococcus*
237. Chemosynthetic bacteria are those:
- (a) Who are unable to do photosynthesis
(b) Do not undergo chemical reaction
(c) Utilize the chemical energy for the synthesis of food
(d) Manufacture food in the presence of sunlight
238. The disease which can't be controlled by vaccine:
- (a) Malaria (b) Small pox
(c) Diphtheria (d) T.B.
239. Match the following :
- | | |
|------------|--------------------------------|
| Cholera | <i>Streptococcus pneumonia</i> |
| Pneumoniae | <i>Schizella dysenteriae</i> |
| Dysentery | <i>Clostridium tetani</i> |
| Tetanus | <i>Vibrio cholerae</i> |
240. Bacteria are more considered as plants than animals because of the presence of:
- (a) Small nucleus (b) Plasma membrane
(c) Cell wall (d) Spore formation

- 241. Bacteria differ from virus in having :**
 (a) Cytoplasm (b) their own genetic material
 (c) no proper nucleus (d) Pathogenic nature
- 242. Germ theory of disease was put forth by:**
 (a) Robert Koch (b) Louis Pasteur
 (c) Edward Jenner (d) Leuwenhoek
- 243. The bacterium naturally present in human elementary canal is:**
 (a) *Bacillus subtilis* (b) *E. coli*
 (c) *Azotobacter* (d) *Clostridium*
- 244. The stain used to distinguish gram positive bacteria from gram negative ones is :**
 (a) Eosin (b) Crystal violet
 (c) Carmine (d) Hematoxylin
- 245. Pili in bacteria are used for:**
 (a) Sexual reproduction (b) Prey hunting
 (c) Locomotion (d) Sexual contact
- 246. The site for respiratory activity in bacteria is :**
 (a) Mesosome (b) Episome
 (c) Ribosome (d) Microsome
- 247. Term episome was proposed by :**
 (a) Jacob and Wollman (b) Lederberg and Tatum
 (c) Zinder & Lederberg (d) Avery & Mcleod
- 248. Plasmid is :**
 (a) Extrachromosomal DNA fragment in bacteria
 (b) Plastid
 (c) Starch granules
 (d) Fat granules
- 249. Putrefying bacteria act upon:**
 (a) Proteins (b) Starch
 (c) Fats (d) Carbohydrate
- 250. Which of the following is the most resistant stage in bacteria:**
 (a) Endospore (b) Conidia
 (c) Sperangia (d) Oidia
- 251. First indication of sexuality in bacteria was given by :**
 (a) Lederberg Tatum (b) Griffith
 (c) Zinder (d) Muller

- 252. Transduction in bacteria is mediated by :**
(a) Cosmids (b) F factors
(c) Phage vectors (d) Plasmid vectors
- 253. Conjugation in bacteria was discovered by :**
(a) Lederberg and Tatum (b) Griffith
(c) Jacob and Wollman (d) Zinder and Lederberg
- 254. The literal meaning of virus:**
(a) Venom (b) Poison
(c) Secretion (d) All of these
- 255. The word virus was first used by:**
(a) F.C. Bowden (b) D. Iwanowski
(c) W.M. Stanley (d) Beijerinck
- 256. Viruses are:**
(a) Cellular organisms (b) Non cellular organism
(c) Unicellular organisms (d) Cellular without wall
- 257. Edward Jenner discovered:**
(a) Vaccination against chicken pox (b) Vaccination against small pox
(c) Immunisation for small pox (d) Immunisation for chicken pox
- 258. Infective nature of TMV disease was discovered by:**
(a) Iwanowsky (b) Meyer (c) Beijerinck (d) Stanley
- 259. Virus was first discovered by:**
(a) Leavwenhoek (b) D. Iwanowsky (c) Beijerinck (d) Stanley
- 260. Bacteriophage is:**
(a) A virus attacking a bacterium
(b) A bacterium attacking a virus
(c) A stage in the life cycle of a bacterium
(d) A virus attacking another virus.
- 261. Bacteriophage was discovered by:**
(a) Iwanowsky (b) Twort (c) Stanley (d) Loeffler
- 262. 'Infective portion of a virus is nucleic acid' it was discovered by:**
(a) DeHerelle (b) Hershey and Chase
(c) Stanley (d) Iwanowsky
- 263. The group of viruses which attack cyanobacteria are termed**
(a) Bacteriophages (b) Cyanophages
(c) Mosaic viruses (d) Phages only

- 264. Viruses are essentially made up of:**
 (a) Protein and nucleic acid (b) Protein and carbohydrate
 (c) Lipids and nucleic acids (d) Starch, protein and lipids
- 265. The genetic material of viruses is:**
 (a) Only RNA (b) Only DNA
 (c) DNA or RNA (d) Both DNA and RNA
- 266. Virion refers to:**
 (a) Capsid of virus (b) Dead virus
 (c) Nucleic acid of virus (d) Complete form of virus
- 267. Double stranded RNA is present in:**
 (a) Ribovirus (b) Reovirus and Penicillium virus
 (c) Pox virus and LPP-I (d) Arbovirus
- 268. TMV contains:**
 (a) ssRNA (b) ssDNA (c) dsRNA (d) ssDNA
- 269. DNA containing plant virus is:**
 (a) Cauliflower mosaic virus (b) Tobacco mosaic virus
 (c) Potato mosaic virus (d) Tomato mosaic virus
- 270. Viral envelope is made up of:**
 (a) Protein (b) Lipid (c) Lipoprotein (d) Mucilage
- 271. AIDS is caused by virus:**
 (a) HTLV- III (or LAV or ARV-2) (b) SV- 40
 (c) ϕ x 174 (d) Any of these
- 272. Which physiological process is exhibited by viruses:**
 (a) Protein synthesis (b) Photosynthesis
 (c) Self duplication (d) Transcription
- 273. Viruses synthesize their protein coat:**
 (a) Inside host cell (b) Outside host cell
 (c) Both inside and outside host cell (d) In extra cellular environment
- 274. A bursting of an infected cell to release virus particles is called:**
 (a) Lysogeny (b) Lysis (c) Eclipse (d) Dehiscence
- 275. A viral nucleic acid integrated with host genome is called:**
 (a) Bacteriophage (b) Macrophage
 (c) Cyanophage (d) Prophage
- 276. A phage which involves a host but does not destroy it, is called:**
 (a) Temperate phage (b) Phycophages
 (c) Virulent phage (d) Mycophage

277. The virus free clones can be obtained from:

- (a) Root (b) Stem
(c) Leaves (d) Apical meristem

278. Cryptogram of TMV is:

- (a) R/2: 2/5: E/E: X/S (b) R/1: 2/5: E/E: S/X.
(c) R/1: 1/8:S/S: S/Ap. (d) R/1: 2/7: E/E: S/X

279. Ganga water does not get spoil due to the presence of:

- (a) Minerals (b) Antibiotics (c) Algae (d) Phages

280. Antiviral substance produced by animals (or many vertebrates in response to viral infection for resisting the multiplication of viruses) is known as:

- (a) virion (b) Interferon (c) Antivirin (d) Antigen

281. Scrapie disease of cattle is caused by:

- (a) Bacteria (b) Virion (c) Prion (d) Mycoplasma

282. Interferon was useful in controlling:

- (a) Cancer (b) T.B. (c) Blood pressure (d) Malaria

283. Which one of the following enzymes is present in the bacteriophage:

- (a) Protease (b) Lysozyme
(c) Succinic dehydrogenase (d) Urease

284. Mycoplasma was first of all discovered by:

- (a) Leuwenhook (b) Nocard & Rowx
(c) Ivanowski (d) Wacksman

285. Mycoplasma are kept in:

- (a) Mollicutes (b) Eubacteria
(c) Spirochaetes (d) Cyanobacteria

286. Smallest cellular organism is:

- (a) Virus (b) Mycoplasma
(c) Algae (d) Yeast

287. Little leaf of brinjal is caused by:

- (a) P.P.L.O. (b) Mycoplasma
(c) Both (d) None of the above

288. The most effected part in plants infected by mycoplasma is:

- (a) Epidermis (b) Xylem tissues
(c) Cortex (d) Phloem tissue

289. The function of elementary bodies in mycoplasma is:

- (a) Reproduction (b) Respiration
(c) Digestion (d) Excretion

290. Closest relative of mycoplasma is:

- (a) Bacteria
- (b) Cyanobacteria
- (c) Algae
- (d) Fungi

291. Cell membrane in mycoplasma:

- (a) One layered
- (b) Two layered
- (c) Three layered
- (d) Four layered

292. Mycoplasma tolerating high temperature is:

- (a) Spiroplasma
- (b) Achleoplasma
- (c) Thermoplasma
- (d) None of the above

293. Mycoplasma are transmitted in plants by:

- (a) Water
- (b) Air
- (c) Ant
- (d) By leaf hopper

294. Blue green algae are kept in:

- (a) Cyanophyceae
- (b) Chlorophyceae
- (c) Fungi
- (d) Pheophyceae

295. The fertility of soil is increased by:

- (a) Green algae
- (b) Blue green algae
- (c) Brown algae
- (d) Red algae

296. Sexual recombination occurs in:

- (a) Virus
- (b) Mycoplasma
- (c) Blue-green algae
- (d) Green algae

297. Cell wall of blue green algae is made of:

- (a) Protein
- (b) Lipoprotein
- (c) Fats
- (d) Mucopetide

298. The cyanobacteria found in the elementary canal of mammal is:

- (a) Oscillatoria
- (b) Gleocapsa
- (c) Calothrix
- (d) Anabaena

299. The sexual recombination in cyanophyceae was reported by:

- (a) Presscott
- (b) Desikachari
- (c) Kumar
- (d) Fritsch

300. Edible cyanobacteria is:

- (a) Oscillatoria
- (b) Calothrix
- (c) Scytonema
- (d) Spirullina

301. Pseudobranchign is found in:

- (a) Scytonema
- (b) Nostoc
- (c) Oscillatoria
- (d) Phormidium

ANSWERS

1. (d) 2. (d) 3. (b) 4. (c) 5. (d) 6. (c) 7. (d) 8. (b) 9. (b) 10. (c)
 11. (c) 12. (d) 13. (b) 14. (b) 15. (b) 16. (c) 17. (c) 18. (c) 19. (a) 20. (d)
 21. (d) 22. (a) 23. (a) 24. (b) 25. (c) 26. (b) 27. (a) 28. (a) 29. (c) 30. (b)
 31. (b) 32. (b) 33. (c) 34. (c) 35. (c) 36. (a) 37. (b) 38. (a) 39. (b) 40. (a)
 41. (a) 42. (a) 43. (c) 44. (d) 45. (b) 46. (a) 47. (a) 48. (a) 49. (b) 50. (c)
 51. (a) 52. (b) 53. (b) 54. (a) 55. (a) 56. (d) 57. (c) 58. (a) 59. (c) 60. (c)
 61. (e) 62. (d) 63. (c) 64. (a) 65. (d) 66. (d) 67. (a) 68. (c) 69. (c) 70. (b)
 71. (d) 72. (a) 73. (b) 74. (c) 75. (b) 76. (c) 77. (c) 78. (d) 79. (c) 80. (a)
 81. (c) 82. (b) 83. (c) 84. (d) 85. (d) 86. (d) 87. (d) 88. (a) 89. (d) 90. (b)
 91. (a) 92. (a) 93. (a) 94. (b) 95. (a) 96. (a) 97. (a) 98. (g) 99. (d) 100. (b)
 101. (d) 102. (b) 103. (b) 104. (a) 105. (b) 106. (a) 107. (b) 108. (a) 109. (c) 110. (a)
 111. (b) 112. (a) 113. (a&b) 114. (a) 115. (c) 116. (b) 117. (c) 118. (a) 119. (a) 120. (a)
 121. (a) 122. (a) 123. (d) 124. (a) 125. (a) 126. (c) 127. (a) 128. (a) 129. (c) 130. (a)
 131. (c) 132. (a) 133. (a) 134. (c) 135. (a) 136. (a) 137. (a) 138. (c) 139. (a) 140. (d)
 141. (a) 142. (d) 143. (a) 144. (b) 145. (d) 146. (a) 147. (a) 148. (a) 149. (b) 150. (d)
 151. (b) 152. (b) 153. (a) 154. (a) 155. (d) 156. (b) 157. (b) 158. (a) 159. (d) 160. (b)
 161. (a) 162. (c) 163. (a) 164. (a) 165. (a) 166. (a) 167. (d) 168. (c) 169. (a) 170. (d)
 171. (d) 172. (d) 173. (a) 174. (d) 175. (d) 176. (a) 177. (a) 178. (d) 179. (d) 180. (c)
 181. (a) 182. (d) 183. (c) 184. (d) 185. (c) 186. (a) 187. (b) 188. (a) 189. (d) 190. (a)
 191. (c) 192. (c) 193. (c) 194. (a) 195. (a) 196. (b) 197. (a) 198. (c) 199. (a) 200. (d)
 201. (b) 202. (b) 203. (d) 204. (d) 205. (a) 206. (a) 207. (c) 208. (a) 209. (c) 210. (c)
 211. (b) 212. (c) 213. (a) 214. (b) 215. (c) 216. (b) 217. (a) 218. (c) 219. (c) 220. (b)
 221. (b) 222. (d) 223. (a) 224. (d) 225. (c) 226. (d) 227. (b) 228. (c) 229. (a) 230. (b)
 231. (c) 232. (a) 233. (d) 234. (c) 235. (a) 236. (b) 237. (c) 238. (a) 239. () 240. (c)
 241. (a) 242. (a) 243. (b) 244. (b) 245. (d) 246. (a) 247. (a) 248. (a) 249. (a) 250. (a)
 251. (b) 252. (c) 253. (a) 254. (b) 255. (d) 256. (b) 257. (c) 258. (b) 259. (b) 260. (b)
 261. (b) 262. (b) 263. (b) 264. (a) 265. (c) 266. (d) 267. (c) 268. (a) 269. (a) 270. (a)
 271. (a) 272. (c) 273. (a) 274. (b) 275. (d) 276. (a) 277. (d) 278. (a) 279. (d) 280. (b)
 281. (c) 282. (a) 283. (b) 284. (b) 285. (a) 286. (b) 287. (c) 288. (d) 289. (d) 290. (a)
 291. (a) 292. (c) 293. (c) 294. (d) 295. (a) 296. (b) 297. (c) 298. (d) 299. (c) 300. (c)
 201. (d) 302. (a)

INDEX

A

- A. radiosa* 373
A. arcyria 367
Abaca mosaic 157
Acanthamoeba 107
Acanthometra 384
Acetabacter 75, 89, 58, 66
Acholeplasma 55, 58, 68, 265, 269, 270, 272
Achromatium 303
Achromobacter 67
Achylonema 341
Acid thiobacillus 67
Acidaminococcus 68
Acidobacterium 55, 69
Acineta 387
Acquired immune deficiency syndrome 195
Acronematic 346, 373
Acrythosiphon pisum 267
Actinobacillus 58
Actinomadura 55, 63, 335, 337
Actinomicrobium 69
Actinomyces 55, 59, 65, 69, 333
Actinomyces antibioticus 335
Actinomyces bovis, 333
Actinomyces spp 331, 332
Actinomycetes 330
Actinomycosis 334
Actinophrys 373, 377, 378, 384
Actinoplanes 55, 69, 63, 332, 335, 337
Actinosphaerium 378, 384
Actinosynnema 69
Adeno Virus 232
Agaricus bisporous 105, 108, 161, 162, 164
Agricultural Microbiology 3
Agrobacterium 67
Agrobacterium tumefaciens 103
Ainsworth 363
Air Microbiology 3
Akinetes 286, 349
Alcaligenes 54, 64, 67
Alexander Fleming 12
Alexandre Yersin 11
Alfalfa mosaic virus 146
Alfamovirus 146
Algae 339
Algal Cell 345
Algal Flagella 346
Algal pigments 344
Algal Viruses-The Cyanophages 158
Algology or Phycology 2
Allogromia 383
Alphacryptovirus 146
Alphavirus 177
Alysiella 303, 305
Amastigomycota 362
Amoeba 370, 371, 372, 373, 375, 382
Amoeba proteus 370, 372, 375
Amoebobacter 316
Anabaena 54, 64, 66, 276, 277, 278, 280, 282, 288, 313, 341, 349, 355, 388

- Anabaena cycadacearum* 284
Anabaena cycadeae 283
Anabaeniolum 277
Anabaenopsis circulans 160
Anabaenopsis raciborskii 286
Anacystis montana 279
Anacystis nidulans 160, 276, 288
 Anaerobacter 68
 Anaerobic Spore Formers 327
Anaeroplasma 68, 270
Anaplasma 58
Anazuma 155
Ancalochloris 318
Ancalomicrobium 81, 319
 Animal viruses 107
 Anisogamy 350
Anoplophyra 387
 Anoxygenic 290
 Anoxygenic Phototrophic Bacteria 309
Anthoceros 277
 Antibiotics from Actinomycetes 336
 Antiterminator 129
 Antony Van Leeuwenhoek 5, 71
Aphanoplasmodium 366
Aphthovirus 179
Aplanospores 349
 Apple chlorotic leafspot virus 145
 Apple stem grooving virus 145
Aquaspirillum magnetotacium 61
 Aquatic Algae 340
 Aquatic Microbiology 3
Aquifex 54, 63, 65, 389
Aquificae 54
Arcella 370, 371, 372, 377, 383
Arcella & Amoeba 372
 Archaea 54, 251, 253
 Archaeobacterial cell wall 254
Archaeoglobi 54
Archaeoglobus 54, 62, 65, 257, 262, 391
Archangium 62, 305
Arcyria 367
 Arenavirus 178
 Aristotle 28
Arthospira 276
Arthrobacter 55, 69
Aspergillus 161, 162, 358
Aspergillus niger 360
A. fumigatus 206
Asterococcus mycoides 263
Asteroplasma 270
Asticcacaulis 319
 Asuyama 263
Aulacomonas submarina 107
 Autogamy 350
 Automixis 378
 Autospores 349
 Autotrophic 88
 Autotrophic or Holophytic Nutrition 375
 Auxospore 349
 Aviadenovirus 238
 Axopodia 373
Azotobacter 85
Azolla 313, 341
Azorhizobium 67, 390
Azospira 67
Azospirillum 57, 66
Azotobacter 54, 57, 91
- B**
- B.M. Dugger 12
Babesia 370, 383
Bacillus 55, 59, 65, 68, 89, 92, 95, 326, 332, 389
Bacillus anthracis 7, 10, 102, 327, 393
Bacillus coli 102
Bacillus denitrificans, 103
Bacillus megatherium 86, 327
Bacillus oligocarbophilus 89
Bacillus sphaericus 93
Bacillus subtilis 93, 94, 333
Bacillus tuberculosis 74
 Bacteria 54, 71
 Bacterial virus T4 124, 125
 Bacterioidetes 55
 Bacteriology 2
 Bacteriophage Lambda 128
 Bacteriophages 107
 Bacteriovorax 68
Bacteroides 58, 69, 391
 Bacteroidetes Bacteroides 55
 Bactoderma 89
 Badnavirus 147
Balantidium 376, 386
Ballionella 89
 Banana bunchy top virus 147
 Barley stripe mosaic virus 145
 Barley yellow dwarf virus 145
Bartonella 58, 67
Bartonella quintana 301
Batrachospermum 344, 353, 355
 Bean golden mosaic virus 147
Beauveria bassiana 156
 Beet curly top virus 147
 Beet yellows virus 145
Beggiatoa 61, 75, 86, 88, 303, 304, 305, 307, 389
Beggiatoa mirabilis 73
 Begomovirus 147, 151
Beijerinckia 54, 58, 67, 104
Bemisia tabaci 152
Bergeyella 70
Betacryptovirus 146
Bifidobacteria 69
Bifidobacterium 55, 393
 Bilgrami 363
Bilophococcus 61
 Binary fission 90
 Biochemical 38

- Biotechnological Potential of Actinomycetes 334
 Biotechnology 3
 Biovars 30
 Blastobacter 61, 319
Blattabacterium 70
Blepharisma lateritia 372
 Bodo 382
Boletus edulis 163
Bordetella 67
Borrelia 55, 69, 291, 294, 295
Borrelia burgdorferi 296, 394
Borrelia recurrentis 394
Botrydium 341, 344, 355
 Boveria 387
 Bowden 104
 Brachiaria 157
Bradyrhizobium 67, 390
Brevibacillus 68
 Broad bean wilt virus 146
 Brome mosaic virus 146
 Bromoviridae 146
 Bromovirus 146
Brucella 54, 64, 67
Bryopsis 348
 Budding 91, 377
 Budding and Appendaged Bacteria 319
 Budding Bacteria 290, 318
 Bunyaviridae 146
 Bunyavirus 178
 Burkholderia 54, 67
 Bursaria 387
 Bymovirus 145
C
Caelosporidium 385
Calothrix 66, 276
Calothrix peritina 277
Calothrix weberi 284
Campylobacter 55, 57, 64, 68
Campylobacter jejuni 392
 CaMV (Cauliflower mosaic virus) 165
Candida albicans 206
 Capillovirus 145
 Capsules 81
 Carbon bacteria 89
Carchesium polypinum 107
Cardiobacterium 67
 Cardiovirus 179
 Carl R. Woese 33
 Carl Weigert 71
 Carlavirus 145
 Carmovirus 145
 Carnation latent virus 145
 Carnation mottle virus 145
 Carnation ring spot virus 145
 Carolus Linnaeus 28
 Carospore 349
 Caryophanon 55, 68
Catharanthus roseus 271
 Cat-scratch Disease 301
Caulerpa 342
 Cauliflower mosaic virus 147
 Caulimoviridae 147
 Caulimovirus 147
 Caulobacter 54, 61, 67, 81, 320, 390
Caulococcus 320
 Cavalier Smith 33
 Cell Division in the Spirochetes 293
Cellulomonas 69
Cephaleuros virescens 341
Ceratiomyxa 368, 385
 Ceratiomyxomycetidae 368
 Ceratium 370, 376, 381
 Cererisiae 107
Cestius phycitis 274
Cetobacterium 70
 Chaemosiphon 277, 287, 289, 349
 Chara 107, 340, 342, 347, 348, 349, 350, 354
 Characteristic features of Cyanobacteria 312
 Characteristic features of Myxomycetes 364
 Characteristics of Rickettsias Important in Human 299
 Characteristics of the Major Groups of Phototrophs 310
 Characters of Mycoplasmas and Viruses 264
 Characters used for the classification of Bacteria 37
 Chase 105
 Chemical origin of Life (Chemogeny) 20
 Chemolithotrophic Bacteria 308
 Chemolithotrophs 290, 307
 Chemosynthetic bacteria 88
 Chilomonas 374, 381, 382, 386
 Chlamydia 69, 290, 301, 303
Chlamydia pneumoniae 392
Chlamydia psittaci 392
Chlamydia trachomatis 303, 392
Chlamydiae Chlamydia 55
Chlamydomonas 342, 349, 350, 374, 377
Chlorella 107, 341, 342, 349
Chlorobacterium 88
Chlorobi 54, 64
Chlorobium 54, 59, 66, 88, 317, 318, 388
Chloroflexi 54
Chloroflexus 54, 60, 64, 66, 303, 317, 318, 388
 Chloroherpeton 59, 318
 Chloromonadophyta 356
 Chloronema 318
 Chlorophyta 354, 356
Cholera vibrio 77

- Chondromyces* 305, 390
Chorda tomentosa 160
 Chromatic adaptation 281
Chromatium 54, 59, 64, 67, 88, 310, 315, 316, 388
Chromulina 355, 381
Chroococcus 66, 277, 289, 341
Chroococcus turgidus 280
Chrosodendron 343
Chryogenes 54
Chrysamoeba 381
Chrysidiastrum 343
Chrysiogenetes 54, 66
 Chrysophyta 355, 356
 Cilia 380
Cladophora 342, 343, 349, 350, 351
Cladothrix 75
Clamydia 58
 Clamydophrys 376
 Class 1 Ciliata 386
 Class 1 Myxosporidea 385
 Class 1 Rhizipodea 382
 Class 1 Telosporea 384
 Class 2 Microsporidea 385
 Class 2 Piroplasma 383
 Class 2 Toxoplasma 385
 Class 3 Actinopodea 383
 Class 3 Haplosporea 385
 Classification by Gasjens and King 117
 Classification of Fungi 357
 Classification of Human Viruses 176
 Classification of Prokaryotes 65
Clathrulina 384
Claviceps 360
Claviceps oryzae sativae 156
 Cledophore 340
Clonothrix 61
Closterovirus 145
Clostridia 329
Clostridium 55, 64, 68, 77, 86, 92, 93, 94, 321, 326, 327, 329, 332, 388, 389
Clostridium botulinum 393
Clostridium perfringens 393
Clostridium tetani 102, 393
Coccidioides immitis 206
Coccolithus 381
Codonella 387
 Cognogeny 26
Coleochaete 342, 344
 Coleps 386
 Collozoum 383
 Colobacter 75
Colpidium 387
 Colpoda 386
 Comamonas 54
 Commensalism 379
 Comoviridae 146
 Comovirus 146
 Comparison of Actinomycetes and Moulds 334
 Comparison of Protein 40
 Conidia 91
 Conjugation 95, 96, 378
 Control of Small Pox 218
 Coprozoic Nutrition 376
Coriobacterium 69
Cornynebacterium 59
 Coronavirus 177
 Corralina 107
Corynebacterium 55, 65, 69, 86, 321, 322
Corynebacterium diphtheriae 102, 393
 Cowpea mosaic virus 146
Coxiella 297, 301
Coxiella burnetii 299, 301, 392
 Coxsackieviruses 183
 C-phycoyanin and phycoerythrin 276
 Crenarchaeota 54, 258, 391
 Crenothrix 70
 Cristispira 69
Cryptococcus neoformans 206
Cryptomonas 374, 381
 Cryptophyta 356
Cryptosporidium parvium 206
Crysamoeba 342
 Cucumber mosaic virus 146, 153
 Cucumovirus 146
 Curtovirus 147
Cuscuta 267, 271
 Cyanobacteria 54, 290, 312
 Cyanophora 280
 Cyanophyta 275, 355, 356
Cycas 277, 341
Cycloclypeus 370
Cycloposthium 387
Cylindrospermum 160, 276, 288
 Cyst 91
 Cystobacter 305
 Cytomegalovirus 177
 Cytonea 277
 Cytophaga 55, 61, 303, 304, 305
 Cytoplasmic inclusions 86
 Cytorthadovirus 146
D
 D. Herelle 104
Dactylosporangium 69
Dactynotus ambrosia 157
 Dairy Microbiology 3
 Darwin 6
Datura stramonium 142
 De contagione 4
 De novo 142
 Deferribacter 54, 66
Deinococcus 54, 59, 66, 389
Deinococcus-Thermus 54
 Deltavirus 250

- Dependovirus* 176
Dermaatophilus 63
Dermocarpa 289, 349
Dermocarpa pacifica 287
Dermocarpus 277
Derxia 67
Desmarestia 354
Desulfobulbus 68
Desulfomonas 68
Desulfosarcina 68
Desulfotomaculum 55, 64, 92, 326, 327
Desulfovibrio 55, 58, 64, 68, 388
Desulfurella 68
Desulfurococcus 63, 255, 257
Dialister pneumocintes 73
Dianthovirus 145
Diatoms 342, 350
Dictyoglomus 55, 70
Dictyola 348
Dictyostaeium 348
Dictyota 352
Didymium 367, 386
Dienococcus thermus 64
Diffugia 370, 371, 383
Dileptus 386
Dimastigamoeba 376
Dimorpha 382
Dinobryon 370, 371
Dinophysis 354
Diplobacillus pneumoniae. 74
Diplobiontic 354
Diplococcus phenumoniae 74, 95
Diplontic Type 350
Diphtheria bacilli 77
Discorbis 372
DNA- RNA virus 176
DNA Sequencing 45
DNA Viruses 147
Doi 263, 270
Dorsalis N. Cincticeps 155
Double-stranded RNA (dsRNA) 146
Dr. Paul R. Burkholder 12
dSDNA viruses 175
dSRNA viruses 176
Dube 363
E
E. coli 96
Echinochloa crusgalli 155
Echinochloa glabrescens 155
Echoviruses 184
Economic Importance of Mycoplasma 266
Ectocarpus 340, 344, 350, 351, 355
Ectothiorhodophila 59
Ectothiorhodospira 316
Edward Jenner 10
Edward L. Tatum 13
Egestion 375
Ehrlichia 66
Ehrlichia chaffeensis 392
Eimeria 385
Eleusine indic 155
Elie Metchnikoff 11
Elphidium 373, 378, 383
Emile Roux 11
Empoasca devastans 274
Enamovirus 146
Endemic Typhus 300
Endomixis 378
Endomyces lactis 359
Endospore forming Rods and Cocci 326
Endospores 92, 287, 349
Ensifer 61
Entamoeba 372, 383
Entamoeba coli 379
Entamoeba histolytica 107, 242
Enterobacter 67, 389, 391
Enterobacteriaceae 391
Enterococcus 55, 68, 388, 393
Enteromorpha 351
Enterovirus 177, 180
Enterovirus Rhinovirus 179
Entodinium 387
Entomoplasma 68, 270
Eobacterium isolatum 25
Ephelota 387
Epidemic Typhus 299
Epstein-Barr Virus (EBV) 228
Era of Molecular Biology 12
Erwinia 68, 103
Erwinia amylovera 103
Erythobacter 60
Escherichia 29, 54, 58, 68
Escherichia coli 28, 102, 124, 125, 128, 131, 133, 212, 389, 391
Eubacterium 55, 68
Eudorina 343, 349, 381
Euglena 342, 354, 370, 372, 373, 374, 375, 376, 379, 381
Euglena gracilis 376
Euglenophyta 354, 356
Euglypha 372
Eukaryota 338
Euplotes 387
European maize mosaic 157
Euryarchaeota 54
Exomicrobiology 3
Exospore 287, 349
F
Fabavirus 146
Falcvibrio 69
Fanne Eilshemius Hesse 10
Father of bacteriology 5
Favella 387
Ferrobacillus 89
Ferroglobus 65
Ferroplasma 54, 65
Fexibacter 70
Fibrobacter 55, 69
Fijivirus 147

- Filopodia 372
 Filovirus 177
 Firmicutes 55
 Flagella 77
 Flagellate Protozoa 379
 Flammiovirga 70
 Flavivirus 177
 Flavobacterium 55, 70
 Flexibacter 55, 303, 305
 Flexithrix 305
 Food Microbiology 3
 Fragmentation 285
 Francesco Redi 5
 Francis Willoughby 29
Frankia 55, 63, 69
 Fritsch 275
Fritschiella 341
 Fuligo 367
 Functions of flagella 79
 Functions of Heterocyst 284
 Functions of Pili 80
 Fungal Viruses-The
 Mycophages 161
 Fungus 356
 Furovirus 145
 Fusobacteria 55
 Fusobacterium 70
G
 G.M. Smith 354
 G.W. Prescott 355
Gaeumannomyces graminis 163
Gallionella 61, 307, 319
 Geminiviridae 147
 Geminivirus 147
 Gemmata 55, 69
 Genera of Green Bacteria 318
 General Account of
 Cyanobacteria 275
 General Characteristics of
 Fungi 357
 General Characters of Bacteria
 71
 General characters of
 Cyanobacteria 275
 General Characters of Viruses
 105
 Generalized Transduction 100
 Genetic Recombination 288
 Genome comparison 39
Geodermatophilus 69
 George Schroeder 6
 George W. Beadle 13
Geothrix 69
Geotoga 54, 66
Geovibrio 54
 Gerhard Domagk 12
 Germination of Endospore 94
Giardia 33, 382
 Gierrer 105
Glaucocystis 280
Glenodinium 370, 372
Gleocapsa 277, 342
Gleocapsa salina 277
 Gliding Bacteria (the
 myxobacteria) 290, 303
Globigerina 373, 383
Gloeocapsa 277, 289
Gloetrichia raciborski 284
Glucanobacter 66
 Golden Age of Microbiology
 8
 Gonidia or Segmentation 91
 Gonimoblast 353
Gracilaria 355
 Gram +ve Bacteria 321
 Gram Staining 101
 Gram -ve Bacteria 290
 Green Bacteria 290, 316
 Green Non-Sulphur Bacteria
 317
 Green sulphur bacteria 310,
 317
Gregarina 384
 Griffith 95
Gromia 383
 Group A viruses 183
 Group B viruses 184
 Gymnomycota 361
H
Haemophilus 54, 58, 95
Haemophilus ducreyi 392
Haemophilus influenzae 392
Halicomenobacter 306
 Halobacteria 54, 261, 262
 Halobacterium 54, 58, 62, 65,
 255, 257, 261, 262, 391
Halobacterium salinarium 261
Halococcus 54, 62, 65, 255, 257,
 261, 262
Haloferax 62
Halorubrum 391
 Halteria 387
 Hantavirus 178
 Haplobiontic 353
 Haplontic Type 350
 Haplosiphon 341
 Harrold Leffries 18
 Helical Symmetry 111
Helicobacter 55, 64, 68
Helicobacter pylori 392
Helicococcus 68
Heliobacterium 55, 60, 388
Heliolithrix 60, 66
Hemitrichia 367
Hemixis 378
 Hepacivirus 250
 Hepadnavirus 177
 Hepamita 382
 Hepatitis A virus 238
 Hepatitis B Virus 239
 Hepatitis C Virus 246
 Hepatitis D Virus 248
 Hepatitis E Virus 248
 Hepatitis G Virus 249
 Hepatitis Viruses 236, 237
 Hepatovirus 179

- Herpes Simplex Virus (HSV) 223
 Herpesvirus 221
 Herpetosiphon 54, 64, 305
 Hershey 105
 Heterochloris 381
 Heterocyst 282
 Heteroharmogonium 341
 Heteromorphic Type 352
 Heterotrophic Bacteria 89
 High Frequency Recombination or Hfr Transfer 97
 Hippocrates 28
Histoplasma capsulatum 206
 Historical Development in the Field of Microbiology 6
 HIV and AIDS 199
 Holmes 115
 Holobacterium 86
 Hologamy 350
 Holophaga 69
 Holospora 66
 Holozoic or Zootrophic 374
Hoplitophyra 387
Hordeivirus 145
 Hormogonia 285
 Horne 115
 Human Diseases Caused by Rickettsia Species 297
 Human Herpesvirus 6 231
 Human Picornaviruses 180
Hydrodictyon 343
 Hydrogen bacteria 89
 Hydrogenobacter 54, 60, 63, 65, 389
Hydrogenomonas 307
Hydrogenophilus 67
Hydromonas 89
Hyella 289
Hyphomicrobium 54, 319, 390
 Hyphomicrobium
 Bdellovibrio 390
Hyphomonas 61, 319
 Hypnospores 349
 Hypomicrobium 67, 75, 91
Hysteroneura setariae 157
I
Ichthyosporidium 385
 Identification of Bacteria 50
Ignaz Semmelweis 6
Ignicoccus 252
 Ilarvirus 146
 Immanuel Kant 17
 Immunology 3
 Inactivated Polio Vaccine (IPV) 182
 Industrial Microbiology 3
 Influenzavirus 177
 Integration of I DNA in *E. coli* Chromosome 131
 Interferon 123
 Iron bacteria 89
 Isogamy 350
 Isomorphic Type 351
Isopora belli 206
Isosphaera 70
 Ivanowski 104
Ixodes 296
J
 Jacob 97
 Jacob Adelberg 98
 Japonica 156
 Jennerian vaccination 225
 Johanson 115
 John Needham 5
 John Ray 29
 John Snow 6
 John Tyndal 9
 Joshua Lederberg 13
K
 Kibdelosporangium 63
 Kineosporia 63
Kinetodesmata 380
Kitasatospora 69
Klebsiella 54, 68, 80, 389
Klebsiella pneumoniae 81, 391
 Kumar 288
 Kusnezovia 320
L
 Laboratory tests for the diagnosis of HIV infection 207
Lachnospira 68
Lactobacilli 41
Lactobacillus 55, 59, 65, 68, 77, 89, 388
Lactococcus 388
 Lambda Infection and the Lytic Pathway 128
Laminaria 340, 344, 352
Lamprocystis 316
Laptonema 69
 Lazzaro Spallanzani 5
 Leaf curl of tomato 151
 Lederberg 96, 99
Leersia hexandra 155
Legionella 54, 58, 67
Legionella pneumophila 392
Leishmania 107, 370, 382
 Lentivirus 178
Leptochlor chinensis 155
Leptomonas 382
Leptosia ictero-hoemorrhigiae 102
Leptospira 55, 69, 242, 291, 294, 390
Leptospira interrogans 394
Leptothrix 61, 75, 89, 306, 390
Leptothrix discophora 306
Leptothrix ochracea 305
 Lettuce necrotic yellows virus 146
Leuconostoc 68
Leuconostoc Propionibacterium 388
Leucothrix 54, 303, 304, 305
 LHT system 116

- Life cycle of Myxomycetes 365
- Liponyssoides 297
- Listeria 59, 65, 68
- Listeria leuconostoc 55
- Lithocircus 383
- Little Leaf of Brinjal or Egg Plant 273
- Lobopodia 372
- Lord Joseph Lister 9
- Louis Pasteur 4, 8
- Luteoviridae 146
- Luteovirus 145
- Lwoff 115
- Lycogala 367
- Lycopersicon hirsutum 152
- Lycopersicon peruvianum 152
- Lymphocryptovirus 177
- Lymphoma HIV Virus 195
- Lyngbya 66, 105, 158
- Lysobacter 61
- Lysogenic Cycle 122
- Lyssavirus 177
- Lytic or Virulent Cycle 120
- M**
- Machlomovirus 145
- Macromonas 60, 308
- Magnetospirillum Spirillum 390
- Maize chlorotic mottle virus 145
- Maize rayado fino virus 145
- Maize streak virus 147
- Major differential features among bacteria, Archae 34
- Major fields of Applied Microbiology 3
- Major fields of pure sciences 2
- Marafivirus 145
- Mastadenovirus 176, 238
- Mastigamoeba 382
- Mastigocladus 277, 279, 289
- Mastigomycota 361
- Mastigophora 380
- Mastri virus 147
- Matthias Schleiden 4
- Max Delbruck 13
- Mayer 104
- Medical Microbiology 3
- Melittangium 305, 319
- Mesorhizobium 390
- Metabolism of Chemolithotrophs 307
- Methane bacteria 89
- Methanobacteria 54
- Methanobacterium 54, 62, 254, 257, 261
- Methanobrevibacter, Methanosphaera 261
- Methanococci 54
- Methanococcus 54, 62, 89, 255, 257, 388, 390
- Methanolobus 62
- Methanomicrobium 62, 255, 257
- Methanopyri 54
- Methanopyrus 54, 65, 252, 261
- Methanosarcina 62, 255, 257
- Methanospirillum 388, 390
- Methanothermus 62, 261, 391
- Methylobacillus 64
- Methylobacterium 54, 64, 67
- Methylococcus 57, 64, 67
- Methylocystis 67
- Methylophilus 54, 67
- Microbacterium 59
- Microbacterium tuberculosis 102
- Microbial ecology 2
- Microbial genetics 2
- Microbial morphology 2
- Microbial phylogeny 46
- Microbial physiology 2
- Microbial taxonomy 2
- Microbispora 63, 69, 332
- Micrococcus 55, 59, 65, 69, 41, 389
- Micrococcus agitis 74
- Micrococcus denitrificans 103
- Micrococcus species 393
- Micrococcus tetragenus 74
- Microcystis 66, 160, 276, 277, 287, 289, 341, 343
- Micromonas pusilla 347
- Micromonospora 63, 69, 332, 333, 335, 337
- Microsporidia 207
- Microtetraspora 63, 69
- Mixotrophic Nutrition 376
- Modern Trends in Classification 36
- Molecular Biology 2
- Molecular Chronometers 46
- Mollicutes 269
- Mollis 269
- Molluscipoxvirus 176, 223
- Monocystis 375, 377, 384
- Monosiga 370, 371
- Morbilivirus 177
- Morphological characters 36
- Morphovars 30
- Morris 105, 275
- Mosaic 157
- Mosaic of Tomato 153
- Mosaic virus 144
- Mucor 358
- Multiple Fission 376
- Multiplication in T4 Phage 126
- Musa textilis 157
- Mycobacteria 86, 321, 323, 324
- Mycobacterium 55, 59, 69, 321, 322, 324, 389
- Mycobacterium avium 326
- Mycobacterium bovis 323
- Mycobacterium fortuitum-chelonei 324, 326
- Mycobacterium kansasii 324, 326

- Mycobacterium leprae* 102, 393
Mycobacterium marinum 326
Mycobacterium scrofulaceum 326
Mycobacterium tuberculosis 10, 12, 201, 210, 242, 322, 323, 393
Mycobacterium ulcerans 326
 Mycology 2
Mycoplasma 55, 58, 64, 68, 263, 265, 266, 268, 269, 270
Mycoplasma agalactiae 268
Mycoplasma bovis 268
Mycoplasma laidlawii 266
Mycoplasma meleagridis 268
Mycoplasma mycoides 268
Mycoplasma pneumoniae 267, 394
 Mycoplasmal Animal Diseases 268
 Mycoplasmal Human Diseases 267
 Mykes 356
 Myrionema 355
 Myroides 70
Mysococcus 64
Myxobolus 385
Myxochloris 381
Myxococcus 55, 62, 305, 390
 Myxogastromycetidae 368
N
 Nannocystis 305
 Nannocytes 287
 Nanoarchaeum 252
 Nassula 386
Natranococcus 65
Natranomonas 65
Natronobacterium 257, 391
 Nature of Viruses 106
Naumannella 308
 Necrovirus 145
Neisseria 54, 58, 67, 74
Neisseria gonorrhoeae 393
Neisseria meningitides 102, 393
 Nematocystis 384
Nephotettix cincticeps 155
Nephotettix virescens 156
 Nepovirus 146
Neurospora 13, 360
Neurospora crassa 13
 Nevskia 61, 319
 Nicolas Appert 6
Nitrococcus 60
 Nitrifying bacteria 89
Nitrobacter 54, 60, 64, 67, 89, 307, 308, 389
Nitrococcus 89, 308, 389
 Nitrogen fixing Cyanobacteria 313
Nitrosococcus 60, 308, 389
Nitrosolobus 60, 308
Nitrosomonas 54, 60, 64, 67, 77, 89, 307, 308, 389
Nitrospira 60
Nitrosovibrio 60
Nitrospira 54, 60, 66, 308
 Nobel laureates in microbiology 14
Nocardia 55, 59, 63, 69, 75, 321, 322, 331, 333, 335
Nocardia asteroides 333
Nocardiopsis 63
Noctiluca 370, 375, 377, 381
Nostoc 54, 64, 66, 289, 341, 343, 348, 355
Nostoc commune 284
Nostoc muscorum 160
 Nuclear Material 86
 Nucleic Acid Hybridization 41
 Nucleic Acid Sequencing 42
 Nucleorhabdovirus 146
 Nutrition 88
 Nutrition in Cyanobacteria 284
Nyctotherus 376, 379, 387
O
Ochrobium 308
Ochromonas 381
Oedogonium 107, 159, 343, 349, 350
 Oidiospores 92
 Oogamy 350
 Opalina 377, 382
Ophiobolus graminis 163
 Order (a) Eucoccida 384
Orientia tsutsugamushi 392
 Orthopoxvirus 176, 222
Oryza 155
 Oryzavirus 147
Oscillatoria 54, 66, 159, 277, 278, 280, 281, 282, 284, 341, 348
Oscillatoria agardhii 282
Oscillatoria princeps 160
Oscillatoria 289, 340
Oscillochloris 318
Oscillospira 277
 Oxygenic Phototrophic Bacteria 290, 311
Oxymonas 382
Oxytricha 370, 387
P
P. aurelia 378
P. caudatum 378
P. chrysogenum 12
P. multimicronucleatum 378
Padiastrum 343
Paecilomyces amoeneroseus, 156
Paenibacillus 55
 Palmella 277, 341, 343, 349
 Palmella Stage 349
Pandorina 343
 Pantonematic 373
 pantonematic flimmer 346
Pantrotroplus 89
 Papillomavirus 176

- Parachlamydia 69
Paramaecium bursaria 375
Paramecium 370, 371, 376, 378, 387
Paramecium aurelia 107, 378
Paramecium caudatum 378
 Paramyxovirus 177
 Paranema 374
 Parapoxvirus 223
 Parasitic bacteria 90
 Parasitic Nutrition 375
 Parasitism 379
 Parasitology 2
 Parsnip yellow fleck virus 145
 Parthenogenesis 377
 Partitiviridae 146
 Pastelsia 342
Pasteurella 68, 77
Pasteurella pestis 102
Pasteuria 63, 319
 Pathogenicity of
 Mycobacteria 323
 Paul Ehrlich 11
 Pea enation mosaic virus 146
Pediastrum 340, 342
Pedicoccus 68
Pediculus 297
Pediculus humanus 295
Pediculus humanus corporis 299
Pedomicrobium 319
Peitchgeisel 346
Pelodictyon 54, 317, 318, 388
Pelomyxa 370, 377, 382
Penibacillus 68
Penicillium 12, 107, 161, 162, 358
Penicillium chrysogenum 12, 163
Penicillium notatum 12
Penicillium stoloniferum 163
Pentachronematic 374
Peptococcus 68
Peptostreptococcus 55, 68
Peranema 374, 376, 381
 Pestivirus 177
 Petrotoga 66
Peziza ostracoderma 163
 Phabdoviridae 146
 Phaeophyta 355, 356
 Phage M13 124
 Phaneroplasmodium 366
Phaseolus vulgaris 142
Phormidium 105, 158, 276, 277, 341
 Photobacterium 390
 Photosynthetic Bacteria 88
 Phycopeltis 341
 Phyllobacterium 67
 Phylogenetic trees 48
Physarum 365, 367
 Physiological anisogamy 350
 Physiological characters 38
 Physiology and Nature of
 Heterocyst 283
 Phytomastigophora 380
Phytophthora infestans 163
 Phytoplasma 269, 272
 Phytoreovirus 147
 Picornaviridae 179
Picrophilus 54, 65, 260, 391
 Pierre Simon de Laplace 17
 Pili or Fimbriae 79
Pinnularia 355
 Pinocytosis 375
Piricularia oryzae 163
Pisum sativum 267
Pithophora 343
Planctomyces 61, 69, 81 319
Planctomycetes Planctomyces 55
Planococcus 68
 Plant like characteristic in
 bacteria 72
 Plant viruses 107, 135
 Plasmid and Episomes 87
 Plasmodiocrap 367
 Plasmodiophora 383
 Plasmodium 368, 370, 376, 377, 385
Plasmodium berghei 107
Plasmodium vivax 107
 Plasmotomy 376
Plectonema 158
Plectonema borryanum 158, 160
Plectononema 105
Pleurocapsa 54, 289
Pleurococcus 341, 348
Pneumococci 41, 95
Pneumocystis carinii 210, 214
 Poliioviruses 181
Polyangium 55, 304, 305
Polycystis 280
 Polyhedral (icosahedral)
 Symmetry 110
 Polymyxa 368
 Polynema 86
 Polyomavirus 176, 234
 Polyphasic taxonomy 51
Polysiphonia 340, 344, 349, 350, 354, 355
Porospora gigantea 370
Porphyromonas 55, 69
 Potato virus X 145, 153
 Potato virus Y 145, 153
 Potato yellow dwarf virus 146
Poteriodendron 370, 371, 372, 382
 Potexvirus 145
Potyngium 62
 Potyviridae 145
 Potyvirus 145
 Poxviridae 217
 Prevotella 55
 Principal Human Diseases
 Caused by Spirochetes
 293
 Prions 109
 Procabacter 67
 Prochloron 54, 60, 313

- Prochlorothrix* 60
Propionibacterium 55, 69
 Prosthecae 320
Prostheco bacter 61, 70, 319
Prosthecochloris 318
Prosthecomicrobium 61, 319, 320
 Proteobacteria 54
 Proterospongia 381
Proteus 54, 68, 80, 268, 389, 391
Protococcus 341
Proto plasmodium 366
Protosiphon 348, 349
 Protozoology 2
Pseudomonas 57, 67, 98, 389
Pseudomonas aeruginosa 392
Pseudomonas citri 77
Pseudomonas solanacearum 103
Pseudonocardia 332
 Pseudopodia 372
 Pseudovacuoles 282
 Psychrophillic 73
 Public Health Microbiology 3
Puccinia graminis 163
Puccinia striiformis 163
Puccinia 163
 Purple Bacteria 290
 Purple Non-Sulphur Bacteria 315
 Purple Sulphur bacteria 310, 315
Pyrococcus 54, 65, 252, 257, 262
Pyrodictium 54, 255, 257, 260, 391
Pyrolobus 391
 Pyrrophyta 354, 356
Pyronympha 382
- Q**
 Q. Fever 301
- R**
Radiolaria 372
Raphidiopsis indica 160
Recilia 155
Recilia dorsalis 155
 Regeneration 377
Renibacterium 59
 Reoviridae 146
 Reovirus 178
 Replication of animal Viruses 169
 Replication of HIV 203
 Replication of RNA Viruses 173
 Replication of Viruses 120
 Reproduction in Bacteria 90
 Rhabdosphaera 381
 Rhabdoviridae 146
 Rhabdovirus 186
 Rhinovirus 177, 185
Rhipicephalus 297
Rhizobia 90
Rhizobium 54, 57, 67, 95, 390
Rhizochloris 342
Rhizopodia 372
Rhizopus 358
Rhodobacter 59, 67, 316, 388
Rhodobium 67
Rhodococcus 59, 63
Rhodocycles 67
Rhodocyclus 316
Rhodomicrobium 75, 311, 316, 318
 Rhodophyta 355, 356
 Rhodopila 316
Rhodopseudomonas 67, 310, 311, 316, 388
Rhodospirillum 54, 59, 66, 310, 311, 316
Rhopalosiphum maidis 157
 Rice Fiji disease virus 147
 Rice ragged stunt virus 147
 Rice stripe virus 146
 Rice tungro bacilliform virus 147
 Rice tungro spherical virus 145
 Rice Tungro Viruses 154
Rickettsia 54, 58, 64, 66, 290, 297, 298
Rickettsia prowazekii 296, 392
Rickettsia rickettsi 298, 392
Rivularia 66, 277, 278, 289
 RNA finger printing 44
 RNA Viruses 144
 RNA-DNA viruses 176
 Robert Koch 10
 Rocky Mountain Spotted Fever 300
 Rod Shaped Bacteria or Bacillus 74
 Rotaviruses 192
 Round 275
 Rubivirus 177
 Rubrobacter 69
Rubus 341
Rumex acetosa 142
 Ryegrass mosaic virus 145
 Rymovirus 145
- S**
Saccharomonospora 63
Saccharomyces 107
Saccharomyces cerevisiae 250
Saccharothrix 63
Salpingoeca 371
Salmonella 54, 68, 77, 80, 95, 98, 99, 268, 389
Salmonella enteritidis 391
Salmonella typhi 391
Salmonella typhiae 102, 103
Salmonella typhimurium 99
Salpingoeca 370, 382
 Salvatore Luria 13
Saprodinium 387
 Saprophytic Bacteria 89
Saprosira 70, 303, 305
Saprosira grandis 304

- Saprozoic Nutrition 375
Sarcinae lutea 74
Sarcocystis 385
 Sarcodina 374
Sarcomastigophora 380
Sargassum 344, 350, 355
 Satellite virus 136
 Satellite virus and Satellite RNA 136
Scenedesmus 343
 Schelsinger 104
Schizella dysenteriae 102, 103
Schizosaccharomyces 359
 Schramm 105
 Sclerotia 359
Sclerotium cepivorum 163, 360
 Sclerotium formation 366
 Scrub Typhus 300
Scytonema 66, 277, 278, 289, 341
 Seliberia 61, 319, 320
Semoncela 277
 Sequiviridae 145
 Sequivirus 145
 Serovars 30
 Serpulina 69
 Serratia 68
 Sexduction 98
 Sexual Reproduction or Genetic Recombination 94
 Shapes and forms of Bacteria 74
 Sheathed Bacteria 290
Shigella 54, 58, 68, 389, 391
Shizaphis graminum 157
Siderocapsa 60, 308
Siderococcus 308
 Similarities between Bacteria and Blue Green Algae 72
Simkania 69
Simonsiella 303, 305
 Simplexvirus 176
Sinorhizobium 67, 390
Sirodotia 159
 Size and shape of various viruses 111
 Size and Structure of Viruses 109
 Sobemovirus 145
 Soil-borne wheat mosaic virus 145
Solanum melongena 273
Solanum nigrum 165
Solanum virus 165
Solanum xanthocarpum 274
 Sorghum red stripe 157
 Southern bean mosaic virus 145
Spaerotilus 307
 Specialized Transduction 100
Sphaerotilus 61, 306, 390
Sphaerotilus natans 75, 305
 Sphingobacterium 55, 70
Sphingomonas 67
 Spiral or Helical 74
 Spirilla 77
 Spirilliplanes 69
Spirillospora 69
Spirillum 57, 67
Spirillum minus *S. volutans* 74
Spirillum undula 77
Spirillum volutans 86
Spirochaeta 390
Spirochaeta 69
 Spirochaete cytophage 103
Spirochaetes Spirochaeta 55
Spirochete 290, 291
Spirochona 386
Spirogyra 343, 350
Spiroplasma 55, 58, 64, 68, 264, 265, 270
Spirosoma 57
Spirostomum 370, 387
Spirulina 66, 278, 284, 304, 342
 Sporangia 366
 Sporangiospores 92
 Sporocytophaga 304, 305
 Sporosarcina 92, 326
 SSDNA viruses 175
 SSRNA 175
 SSRNA virus 175
 stalks 320
 Stanley 104
Staphylococcus aureus 12, 74, 393
 Staphylococci 12
Staphylococcus 12, 41, 55, 68, 99
Staphylococcus epidermidis 393
Staphylococcus saprophyticus 393
Staphylococcus streptococcus 59
 Stella 319, 320
 Stemonitomycetidae 368
Stentor 375, 377, 387
Stentor coeruleus 372
 Stentors 377
 Stichonematic 373
 Stigmatella 305
Stigmatella, Streptomyces Agrobacterium 390
Stigonema 54, 66, 277, 289
Streptobacillus 55
 Streptococci 12, 41
Streptococcus 55, 65, 68, 321, 388
Streptococcus mutans 81
Streptococcus pneumoniae 95, 102, 393
Streptococcus pyogenes 393
Streptococcus lactis 74
Streptomyces 55, 63, 69, 91, 321, 332, 333, 335, 337
Streptomyces avermectilis 336
Streptomyces griseus 12, 333, 334
Streptomyces microflavus 337

- Streptomyces* spp 331
Streptomyces spp. *S. fradiae* 333
Streptomyces tsukubaensis 336
Streptomyces venezuelae 12
Streptomyces 333
Streptosporangium 63, 69, 332, 335
Streptoverticillium 69, 335
 Structure External to the Cell Wall 77
 Structure of Bacterial Cell 73
 Structure of T4 bacteriophage 114
 Structure of Viruses 109
Stylonychia 387
 Sugarcane Mosaic 156
 Sugarcane mosaic virus 157
 Sulfolobus 54, 63, 255, 257, 258, 260, 308, 391
 Sulfolobus, Thermoproteus 255
 Sulphur Bacteria 88
 Super class B Opalinata 382
 Super class C. Sarcodina 382
 Symbiotic bacteria 90
 Symptoms of Mycoplasmal Plant Diseases 267
Synechococcus 54, 277, 313, 388
Synechococcus cedrorum 160
Synechocystis 285
Synecococcus elongatus 160
 Syngamy or copulation 377
Syntrophomonas 68
Synura splendida 370
 Systematic Position of Slime Molds 368
- T**
- T.V. Desikachari 275
 Taq 389
 Tautum 96
Taxomyces andreanae 2
 Taxonomic Criteria Used for Classification 50
Taxus brevifolia 2
 Temperate Bacteriophages 127
 Tenuivirus 146
 Teranaka 263
 Tests for anti-HIV 208
Tetrahymena 387
Tetraspora 343
Thalassicola 383
 Three-domain system 36
 Tidal Hypothesis 18
 Theodor Von Dusch 6
 Theodore Schwann 4
 Theophrastus 29
Thermoactinomyces 55, 63, 68, 332
Thermoanaerobacterium 68
Thermobacillus 68
Thermococci 54
Thermococcus 54, 63, 65, 252, 257, 262, 391
Thermodesulfobacterium 54, 66
Thermodesulfobivrio 66
Thermonicobia 54
Thermomicrobium 54, 66
Thermomonospora 55, 63, 69, 332
 Thermophilic 73
Thermophilus 391
Thermoplasma 54, 62, 65, 252, 257, 268
 Thermoplasmata 54
Thermopolyspora 332
 Thermoproteins 63
Thermoproteus 54, 257, 258, 391
Thermothrix 67
Thermotoga 34, 54, 64, 65
Thermotoga maritima 34
 Thermotogae 54
Thermus 54, 66, 389
Thermus aquaticus 389
Thigmophrya 387
Thiobacillus 54, 67, 88, 307, 308, 389
Thiobacillus denitrificans 103
Thiobacterium 60, 308
Thiocapsa 310, 316
Thiocystis 310, 316
Thiodendron 61, 319
Thiodictyon 310, 315, 316, 388
 Thiomargarita 390
Thiopedia 310, 316
Thioploca 61, 305, 390
Thiosarcina 310
Thiospirillopsis floridana 304
Thiospira 60, 308
Thiospirillum 310, 315, 316, 388
Thiothrix 61, 67, 86, 88, 89, 303, 304, 305, 307, 389
Thiovulum 308
Thraustochytrium 163
Tipula 160
 TMV (Tobacco mosaic virus) 164
 Tobacco 144
 Tobacco leaf curl 151
 Tobacco mosaic virus 111
 Tobacco necrosis virus 145
 Tobacco rattle virus 144
 Tobacco ringspot virus 146
 Tobacco streak virus 146
 Tobamovirus 144
 Tobravirus 144
Tolypothrix 276
 Tomato bushy stunt virus 145
 Tomato mosaic virus 153
 Tomato spotted wilt virus 146
 Tombusviridae 145
 Tombusvirus 145
 Tospovirus 146
 Tournier 115
Toxoplasma 385

Toxoplasma gondii 206, 209, 210, 214, 242
Toxoptera graminum 157
 Traditional characters 36
 Transduction 95, 99
 Transformation 94
 Transmission of HIV-1 and HIV-2 211
 Transmission of Plant Viruses 166
 Trench Fever 301
Treponema 55, 69, 291, 293, 294
Treponema pallidum 11, 57, 242, 294, 393
Trichia 367
Trichodesmium 277, 388
Trichodesmium erythraeum 276
Trichodina 387
Trichomonas 382
Trichonympha 379, 382
Trichovirus 145
 Triphasic Type 353
Trypanosoma 376, 382
 Tubercle 322
 Tubercle Bacillus 322
 Turnip yellow mosaic virus 145
 Tymovirus 145
Typhus exanthematicus 14
U
Ulothrix 340, 342, 343, 348, 349, 350, 354
 Ultrastructure of Flagellum 78
Ulva 344, 351
 Undulating membrane 379
Urcoelus 374

Ureaplasma 55, 68, 269, 270
Ureaplasma ueralyticum 267
Uronema gigas 107
Urostyla 387
Ustilago maydis 107
V
 Vaccination 190
Vampyrella 384
Varicella 226
 Varicellavirus 176
 Varicella-Zoster Virus (VZV) 226
Vaucheria 341, 342, 344, 349, 350
Veillonella 55, 58
Verrucomicrobia
 Verrucomicrobium 55
Verrucomicrobium 70
 Vesiculovirus 177
 Vibrio 54, 58, 67, 98
Vibrio cholerae 75, 102, 103, 392
Vibrio fischeri 390
Vibrio parahaemolyticus 392
Vicia faba 142
 Viral Diseases of Tomato 151
 Viral Genome 115
 Virology 2
 Virus Infection 137
 Viruses in Eukaryotic Microorganism 107
 Virusoides 109
Vitreoscilla 304, 305
Volvox 342, 343, 349, 350, 354, 381
Vorticella 370, 376, 378, 387
W
 Waddlia 69

Waikavirus 145
 Waksman 12
 Waksmania 332
 Walls of Gram +ve and Gram -ve Bacteria 82
 Webster 363
Westiella 279, 289, 348
 White clover cryptic virus 146
 Whittaker Five Kingdom Concept 31
Wiestiella 287
 Woese 44
 Wollman 97
 Woronina 368
 Wound tumor virus 147
X
Xanthomonas 67
Xanthomonas citri 103
 X-bodies 142
Xenopsylla 297
Xenopsylla cheopis 300
Xiphinematobacter 70
Y
 Yatapoxvirus 223
Yersinia 54, 58, 68, 389
Yersinia pestis 391
 Yora 263
Z
 Zinder 99
Zoochlorella 341
 Zoomastigophora 381
 Zoospores 349
Zooxanthella 341, 375
 Zoster 227
Zygnema 340, 350
Zygomonas 67